

SUMMARY



Image is for illustrative purpose only

Wires

Low voltage 16

Series 3K
Termination type Female solder
IP rating 68
AWG wire size 30.00 - 22.00
Cable Ø 0.00 - 0.00 mm
Status active
Matching parts [FGG.3K.316.CLAC11](#)

Download

[Request a quote](#)

[Catalog](#)

TECHNICAL DETAILS

Mechanics

Shell Style/Model EB*: Fixed receptacle with square flange and 4 screw fixing
Keying 1 key (alpha=0, plug: male contacts, receptacle: female contacts)
Housing Material Brass (chrome plated [SAE AMS 2460]) shell and collet nut, nickel plated [SAE AMS QQ N 290] brass latch sleeve and mid pieces
Weight 51.84 g

Performance

Configuration 3K.316 : 16 Low Voltage
Insulator L: PEEK (UL 94 / V-0/1.5)
Rated Current 8 Amps

Specifications

Contact Type: Solder
Contact Dia.: 0.9 mm (0.035in)
Bucket Dia.: 0.8 mm (0.031in)
Max. Solid Conductor: 0.34 mm² (AWG 22)
Max. Stranded Conductor: 0.34 mm² (AWG 22)
R (max): 4.8 mOhm
Vtest (contact-shell): 850 V (AC), 1200 V (DC)
Vtest (contact-contact): 1200 V (AC), 1700 V (DC)

LEMO products and services are provided "as is". LEMO makes no warranties or representations with regard to LEMO product & services or use of them, express, implied or statutory, including for accuracy, completeness, or security. The user is fully responsible for his products and applications using LEMO components.

Others

Endurance (Shell): 5000 mating cycles
Temp (min / max): -55 °C / +200 °C
Humidity (max): <=95% [at 60 deg C / 140 F]
Vibration: 15 g [10 Hz - 2000 Hz]
Shock Resistance: 100 g [6 ms]
Climatical Category: 50/175/21
Shielding (min): 95 dB (10 MHz)
Shielding (min): 80 dB (1 GHz)
Salt Spray Corrosion: >1000 hr

DRAWINGS

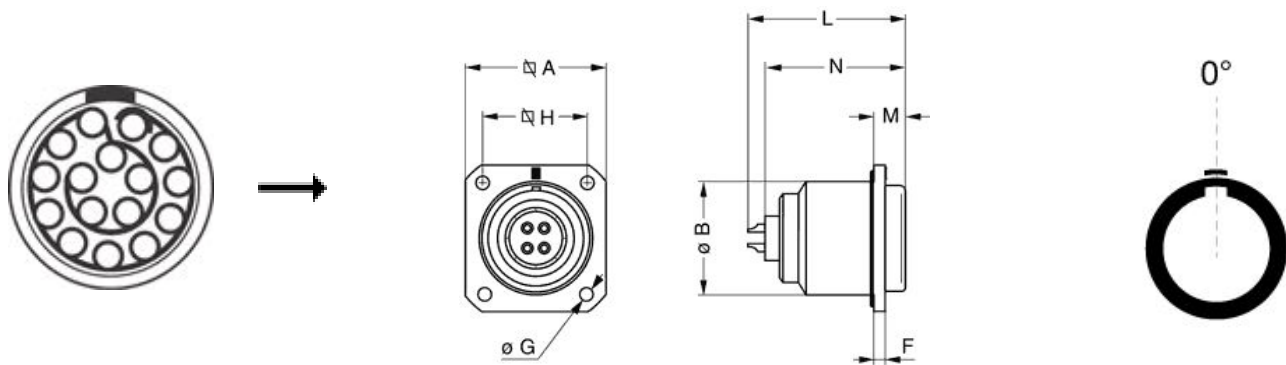

Dimensions









	A	B	F	G	H	L	M	N
mm.	29	23	3	3.4	23	36.2	6	32.6
in.	1,14	0,91	0,12	0,13	0,91	1,43	0,24	1,28

RECOMMENDED BY LEMO

Tools

LEMO products and services are provided "as is". LEMO makes no warranties or representations with regard to LEMO product & services or use of them, express, implied or statutory, including for accuracy, completeness, or security. The user is fully responsible for his products and applications using LEMO components.

Cables

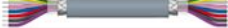
CMN.16.T22.076QGZE	TPR (medical)	Grey	
CMN.16.T28.059PGZE		Grey	
CMN.16.T28.059PNZE			
CMN.16.T28.070NNZZ			
CMN.16.T30.047QGZE	TPR (medical)	Grey	
116080	PUR	Black	
116280	PVC	Black	
16050	PVC	Black	
216220	PVC	Black	
216240	PVC	Black	
216260	PVC	Black	
316250	PVC	Grey	

LEMO products and services are provided "as is". LEMO makes no warranties or representations with regard to LEMO product & services or use of them, express, implied or statutory, including for accuracy, completeness, or security. The user is fully responsible for his products and applications using LEMO components.

Mouser Electronics

Authorized Distributor

Click to View Pricing, Inventory, Delivery & Lifecycle Information:

[LEMO:](#)

[EBG.3K.316.CLL](#)