

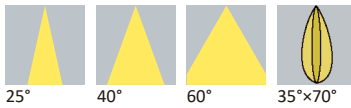

Datasheet BNE Series

Available Distribution



LED

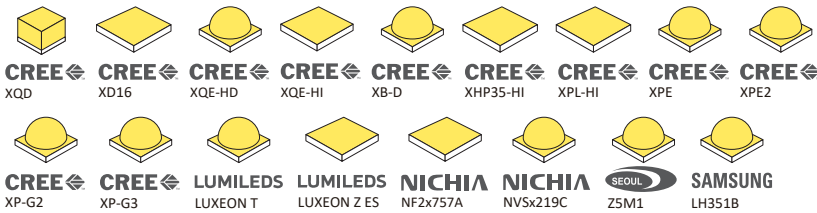

Recommand Applications



General Information

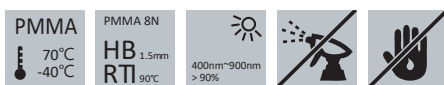

- Lens Material PMMA 8N
- Operating Temperature -40°C~+70°C
- UL Flammability HB @ 1.5mm
- UL RTI Elec 90°C @ 1.5mm
- Light Transmission Rate 400nm~900nm > 90%
- ⚠ If necessary, Clean lenses with mild soap, water and soft cloth.
- ⚠ Never use any commercial cleaning solvents on lenses, like alcohol.
- ⚠ Please handle or install lenses with wearing gloves, skin oils may damage lens or its optical characteristic.

Dimensions

Part Number	Diameter	Height
LL01CR-BNExxL06	Ø19.4	14.6
LL01CR-BNExxL06-Ux	Ø23.5	15.8
LL01NI-BNExxL06-Mx-T	Ø21.4	15.8

*All dimensions are in millimeters.

Packaging Details (SPQ)

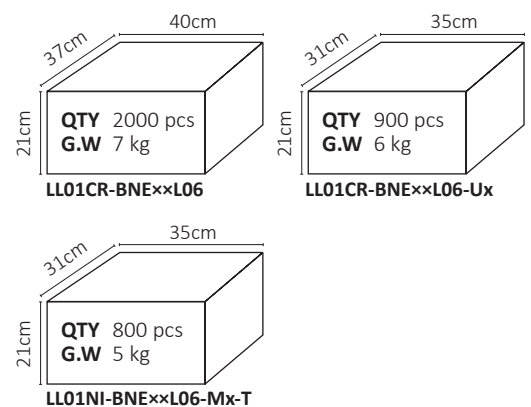

Accessories



- 2 Different Types of Holder
LL01CROT25Hx
LL01NIUD10Hx
- Available with Tape
LL01A00AYDXX

Mechanical Specification

*All dimensions are in millimeters.

Lens Dimension

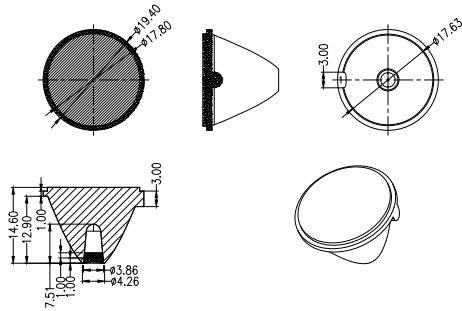

Assembly Instruction

Part No LL01CR-BNE××L06

Fixing Method

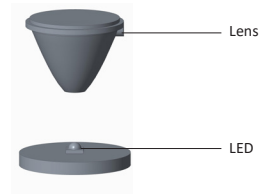

Holder Dimension

LL01CROT25Hx

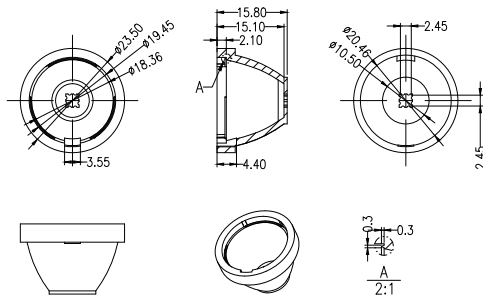

Assembly Instruction

Part No LL01CR-BNE××L06-Ux
Holder LL01CROT25Hx

Fixing Method

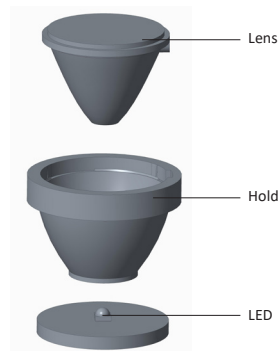

Holder Dimension

LL01NIUD10Hx

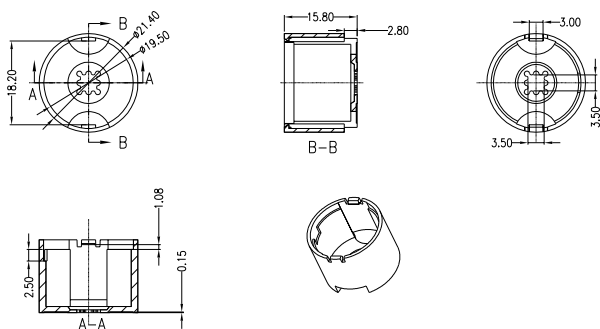

Assembly Instruction

Part No LL01NI-BNE××L06-Mx-T
Holder LL01NIUD10Hx
Tape LL01A00AYDXX

Fixing Method

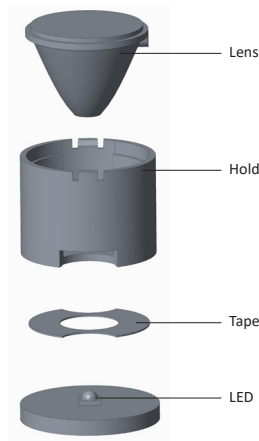

Photometric Distribution

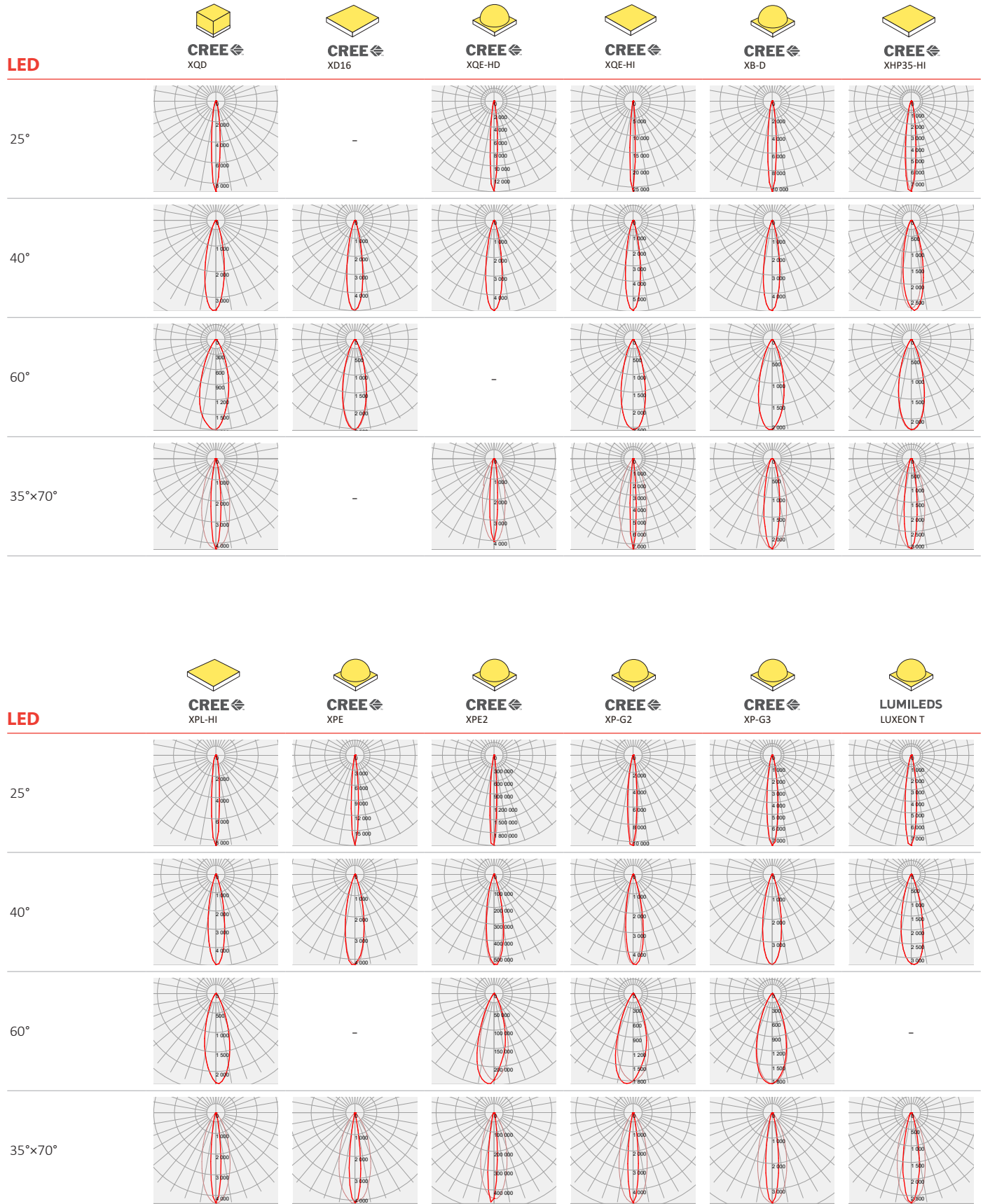



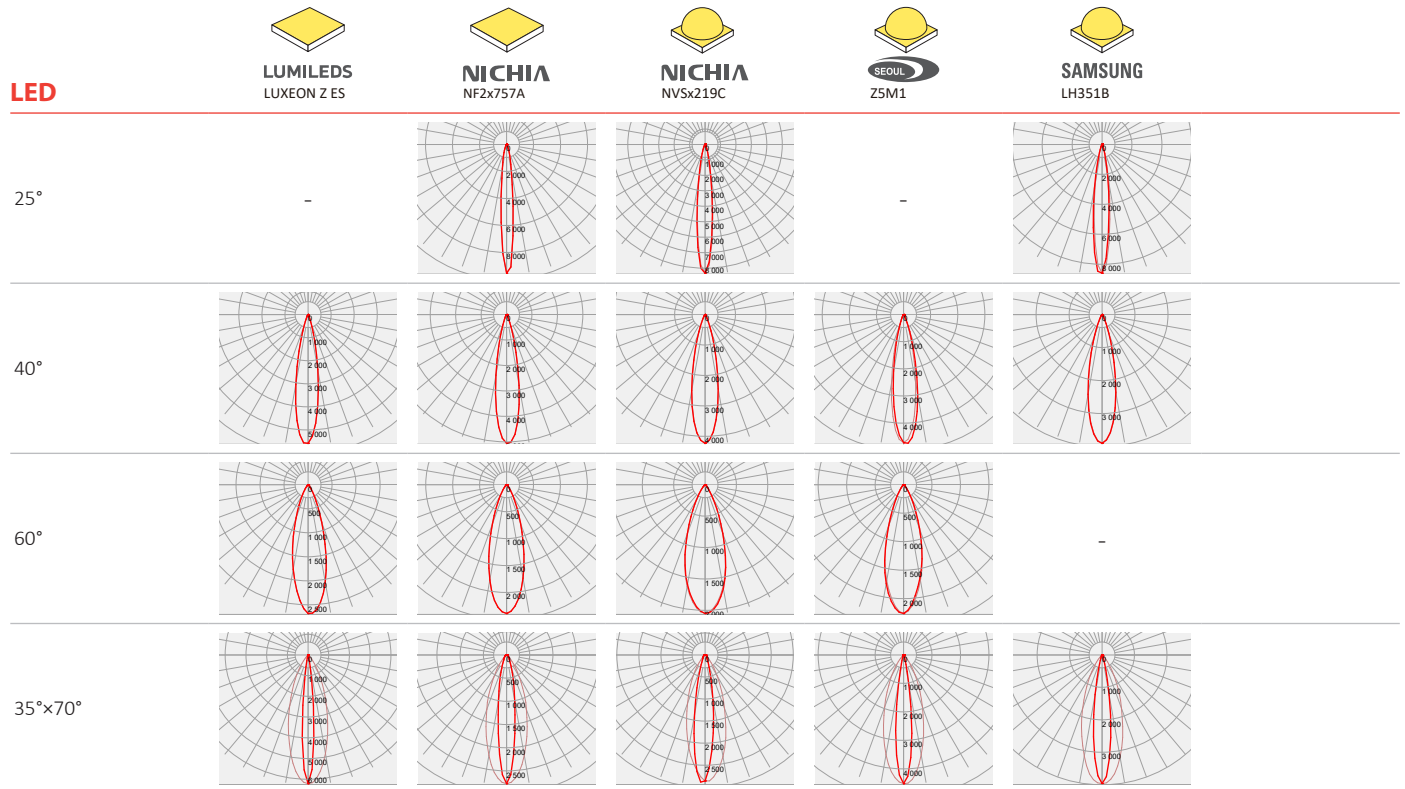







Photometric Distribution



Details by LED

Part No	Holder	Tape	LED Package Size	LED
LL01CR-BNExxL06	-	-	1616 / 1620 / 3535 3737	
LL01CR-BNExxL06-Ux	 LL01CROT25Hx	-	2525	
LL01NI-BNExxL06-Mx-T	 LL01NIUD10Hx	 LL01A00AYDXX	3535	





LL01CR-BNExxL06

LED	Part No	FWHM	cd / lm	IES
 CREE XQD	LL01CR-BNE25L06	11°	8.7	↓
	LL01CR-BNE40L06	24°	3.5	↓
	LL01CR-BNE60L06	36°	1.8	↓
	LL01CR-BNE3570L06	12°×35°	4.2	↓
 CREE XD16	LL01CR-BNE25L06	-	-	-
	LL01CR-BNE40L06	19°	4.9	↓
	LL01CR-BNE60L06	29°	2.5	↓
	LL01CR-BNE3570L06	-	-	-
 CREE XQE-HD	LL01CR-BNE25L06	9°	13.9	↓
	LL01CR-BNE40L06	20°	4.8	↓
	LL01CR-BNE60L06	-	-	-
	LL01CR-BNE3570L06	11°×32°	4.4	↓
 CREE XQE-HI	LL01CR-BNE25L06	7°	26.2	↓
	LL01CR-BNE40L06	19°	5.9	↓
	LL01CR-BNE60L06	30°	2.5	↓
	LL01CR-BNE3570L06	7°×34°	7.4	↓
 CREE XHP35-HI	LL01CR-BNE25L06	13°	7.8	↓
	LL01CR-BNE40L06	25°	2.8	↓
	LL01CR-BNE60L06	32°	2.2	↓
	LL01CR-BNE3570L06	16°×35°	3.0	↓
 CREE XPL-HI	LL01CR-BNE25L06	10°	8.5	↓
	LL01CR-BNE40L06	20°	4.9	↓
	LL01CR-BNE60L06	31°	2.3	↓
	LL01CR-BNE3570L06	13°×34°	4.3	↓
 CREE XPE2	LL01CR-BNE25L06	8°	20.5	↓
	LL01CR-BNE40L06	21°	5.4	↓
	LL01CR-BNE60L06	34°	2.4	↓
	LL01CR-BNE3570L06	11°×35°	4.7	↓
 LUMILEDS LUXEON T	LL01CR-BNE25L06	14°	7.8	↓
	LL01CR-BNE40L06	26°	3.2	↓
	LL01CR-BNE60L06	-	-	-
	LL01CR-BNE3570L06	20°×35°	2.7	↓
 LUMILEDS LUXEON Z ES	LL01CR-BNE25L06	-	-	-
	LL01CR-BNE40L06	19°	5.5	↓
	LL01CR-BNE60L06	29°	2.6	↓
	LL01CR-BNE3570L06	10°×35°	6.2	↓
 NICHIA NF2x757A	LL01CR-BNE25L06	10°	9.5	↓
	LL01CR-BNE40L06	20°	5.0	↓
	LL01CR-BNE60L06	30°	2.3	↓
	LL01CR-BNE3570L06	15°×36°	2.7	↓
 SEOL ZSM1	LL01CR-BNE25L06	-	-	-
	LL01CR-BNE40L06	21°	4.7	↓
	LL01CR-BNE60L06	32°	2.2	↓
	LL01CR-BNE3570L06	14°×35°	4.5	↓

LL01CR-BNExxL06-Ux

LED	Part No	FWHM	cd / lm	IES
 CREE XB-D	LL01CR-BNE25L06-U2	11°	10.3	↓
	LL01CR-BNE40L06-U2	20°	4.9	↓
	LL01CR-BNE60L06-U2	32°	2.0	↓
	LL01CR-BNE3570L06-U2	20°×36°	2.3	↓

LL01NI-BNExxL06-Mx-T

LED	Part No	FWHM	cd / lm	IES
 CREE XPE	LL01NI-BNE25L06-M2-T	9°	17.9	↓
	LL01NI-BNE40L06-M2-T	23°	4.2	↓
	LL01NI-BNE60L06-M2-T	-	-	-
	LL01NI-BNE3570L06-M2-T	14°×40°	4.1	↓
 CREE XP-G2	LL01NI-BNE25L06-M2-T	12°	10.4	↓
	LL01NI-BNE40L06-M2-T	21°	4.6	↓
	LL01NI-BNE60L06-M2-T	37°	1.8	↓
	LL01NI-BNE3570L06-M2-T	13°×35°	4.7	↓
 CREE XP-G3	LL01NI-BNE25L06-M2-T	14°	7.6	↓
	LL01NI-BNE40L06-M2-T	23°	3.9	↓
	LL01NI-BNE60L06-M2-T	37°	1.8	↓
	LL01NI-BNE3570L06-M2-T	16°×36°	3.5	↓
 NICHIA NVSx219C	LL01NI-BNE25L06-M2-T	13°	8.3	↓
	LL01NI-BNE40L06-M2-T	23°	4.2	↓
	LL01NI-BNE60L06-M2-T	35°	2.0	↓
	LL01NI-BNE3570L06-M2-T	17°×35°	2.9	↓
 SAMSUNG LH351B	LL01NI-BNE25L06-M2-T	14°	8.5	↓
	LL01NI-BNE40L06-M2-T	24°	3.9	↓
	LL01NI-BNE60L06-M2-T	-	-	-
	LL01NI-BNE3570L06-M2-T	15°×36°	3.9	↓

Product Nomenclature

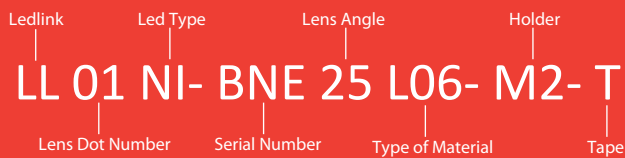

Ledlink Optics, Inc

Taiwan HQ

15F, No.655, Bannan Rd., Chung-Ho Dist.,
New Taipei City, Taiwan 235

Ledlink Optics (Dongguan) Co., Ltd

Dongguan Factory

No.5, TianKeng Industrial Dist., HengLiTown, DongGuan City,
GuangDong Province, China 523478

Ledlink Optics (Yangzhou) Co., Ltd

Yangzhou Factory

No.180, LinJiang Rd., YangZhou City, Jiangsu Province, China 225009

www.ledlink-optics.com

service@ledlink-optics.com



Mouser Electronics

Authorized Distributor

Click to View Pricing, Inventory, Delivery & Lifecycle Information:

[LedLink Optics:](#)

[LL01CR-BNE25L06](#) [LL01CR-BNE60L06](#) [LL01CR-BNE40L06](#) [LL01CR-BNE60L06-U2](#) [LL01CR-BNE40L06-U2](#)
[LL01NI-BNE40L06-M2-T](#) [LL01CR-BNE3570L06-U2](#) [LL01CR-BNE3570L06](#) [LL01NI-BNE25L06-M2-T](#) [LL01CR-](#)
[BNE25L06-U2](#) [LL01NI-BNE60L06-M2-T](#)