

**Xinger**<sup>®</sup>

**Hybrid Coupler**  
**3 dB, 90°**



**Description:**

The XMC0204E2-03G is a low profile, high performance 3dB hybrid coupler in a new easy to use, manufacturing friendly surface mount package. It is designed for broadband S-band radar applications and high reliability applications in the 2000 MHz to 4000 MHz range. It can be used in high power applications up to 200 Watts.

Parts have been subjected to rigorous qualification testing and they are manufactured using materials with coefficients of thermal expansion (CTE) compatible with common substrates such as FR4, G-10, RF-35, RO4350 and polyimide. Available in 6 of 6 ENIG (XMC0204E2-03G) RoHS compliant finish.

**Features:**

- 2000 - 4000 MHz
- S Band Radar
- High Power
- Very Low Loss
- Tight Amplitude Balance
- High Isolation
- Production Friendly
- Tape and Reel
- ENIG Finish

**Electrical Specifications:**

Frequency	Isolation	Insertion Loss	VSWR
MHz	dB Min	dB Max	Max : 1
2700 - 3500	23	0.20	1.15
2300 - 4000	20	0.25	1.20
Phase	Power	Amplitude Balance	Operating Temp.
Degrees	Avg. CW Watts @85°C	dB Max	°C
90 ± 4.0	175	± 0.50	-55 to +150
90 ± 4.0	135	± 0.70	-55 to +150

\*Power Handling for commercial, non-life critical applications. See derating chart for other applications  
 \*\*Specification based on performance of unit properly installed on a TTM test board with small signal applied.  
 Specifications subject to change without notice. Refer to parameter definitions for details.

**Mechanical Outline:**

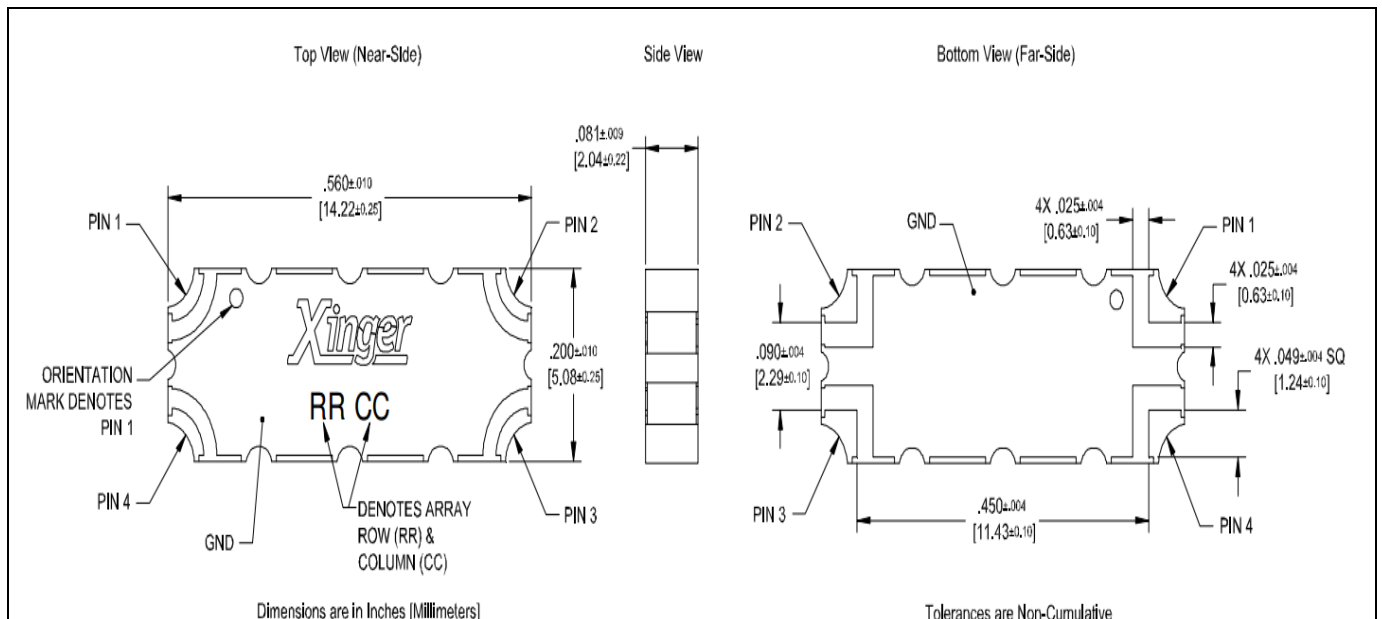

## Hybrid Coupler Pin Configuration

The XMC0204E2-03G has an orientation marker to denote Pin 1. Once port one has been identified the other ports are known automatically. Please see the chart below for clarification:

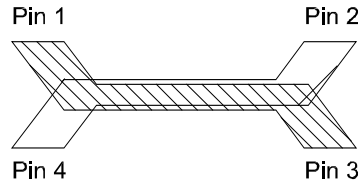

Configuration	Pin 1	Pin 2	Pin 3	Pin 4
<b>Splitter</b>	Input	Isolated	$-3\text{dB } \angle\theta - 90$	$-3\text{dB } \angle\theta$
<b>Splitter</b>	Isolated	Input	$-3\text{dB } \angle\theta$	$-3\text{dB } \angle\theta - 90$
<b>Splitter</b>	$-3\text{dB } \angle\theta - 90$	$-3\text{dB } \angle\theta$	Input	Isolated
<b>Splitter</b>	$-3\text{dB } \angle\theta$	$-3\text{dB } \angle\theta - 90$	Isolated	Input
<b>*Combiner</b>	$A \angle\theta - 90$	$A \angle\theta$	Isolated	Output
<b>*Combiner</b>	$A \angle\theta$	$A \angle\theta - 90$	Output	Isolated
<b>*Combiner</b>	Isolated	Output	$A \angle\theta - 90$	$A \angle\theta$
<b>*Combiner</b>	Output	Isolated	$A \angle\theta$	$A \angle\theta - 90$

\*Note: "A" is the amplitude of the applied signals. When two quadrature signals with equal amplitudes are applied to the coupler as described in the table, they will combine at the output port. If the amplitudes are not equal, some of the applied energy will be directed to the isolated port.

## Peak Power Handling

High-Pot testing of these couplers during the qualification procedure resulted in a minimum breakdown voltage of 1.47kV (minimum recorded value). This voltage level corresponds to a breakdown resistance capable of handling at least 12dB peaks over average power levels, for very short durations. The breakdown location consistently occurred across the air interface at the coupler contact pads (see illustration below). The breakdown levels at these points will be affected by any contamination in the gap area around these pads. These areas must be kept clean for optimum performance. It is recommended that the user test for voltage breakdown under the maximum operating conditions and over worst case modulation induced power peaking. This evaluation should also include extreme environmental conditions (such as high humidity).

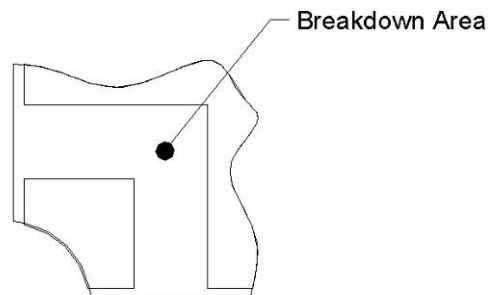

## Insertion Loss and Power Derating Curves

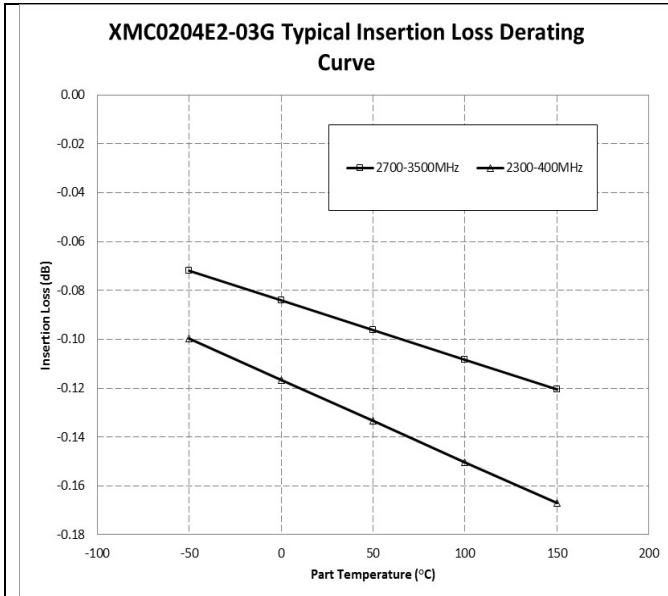

### Insertion Loss Derating

The insertion loss, at a given frequency, of a group of couplers is measured at 25°C and then averaged. The measurements are performed under small signal conditions (i.e. using a Vector Network Analyzer). The process is repeated at 85°C and 150°C. A best-fit line for the measured data is computed and then plotted from -55°C to 150°C.

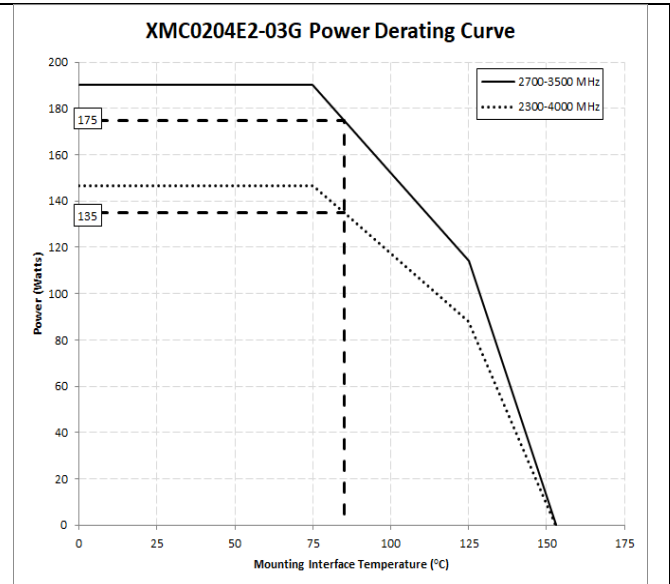

### Power Derating

The power handling and corresponding power derating plots are a function of the thermal resistance, mounting surface temperature (base plate temperature), maximum continuous operating temperature of the coupler, and the thermal insertion loss. The thermal insertion loss is defined in the Power Handling section of the data sheet.

As the mounting interface temperature approaches the maximum continuous operating temperature, the power handling decreases to zero.

If mounting temperature is greater than 85°C, Xinger coupler will perform reliably as long as the input power is derated to the curve above.

**Typical Performance (-55°C, 25°C, 95°C & 150°C): 2000-4000 MHz**

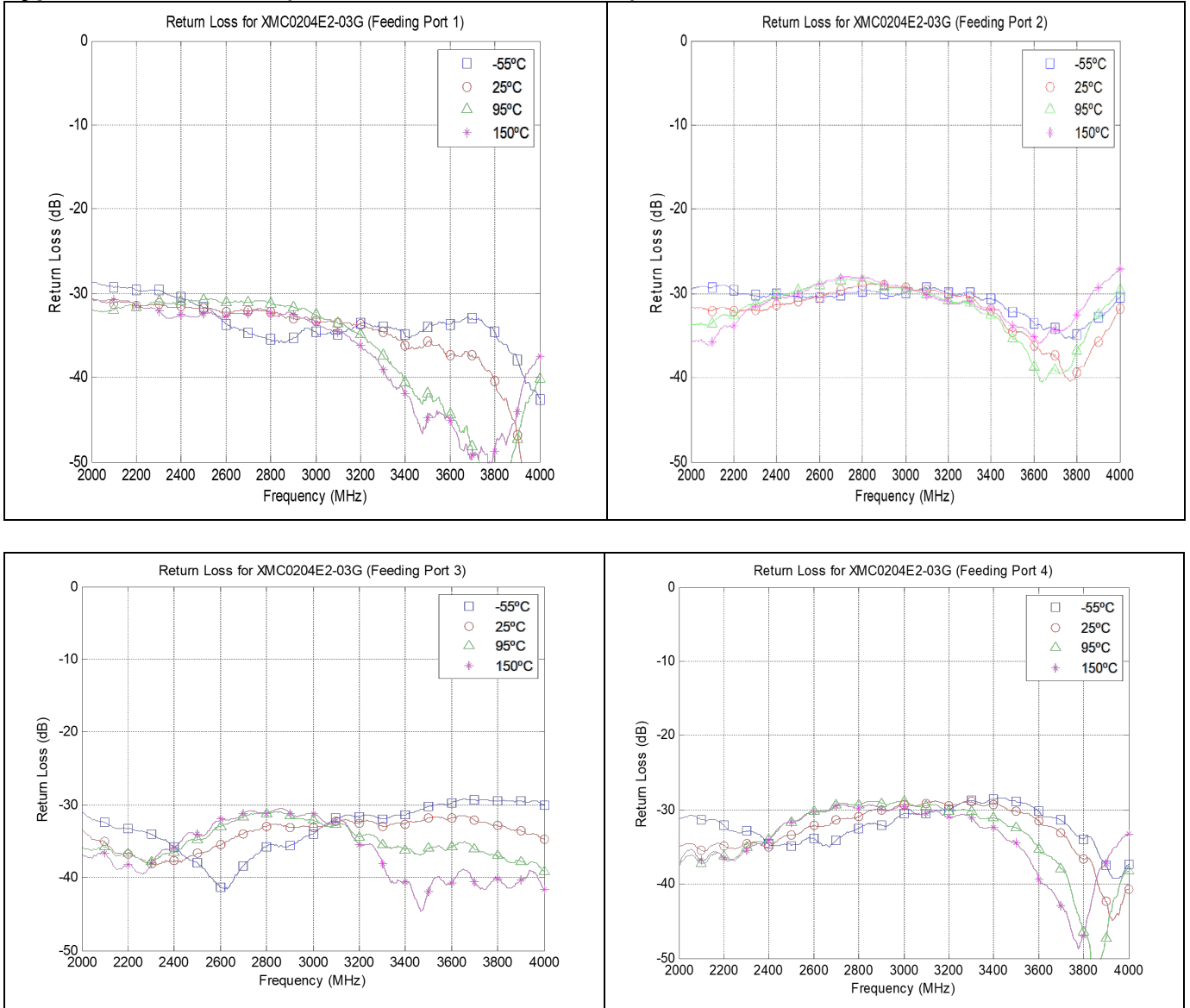

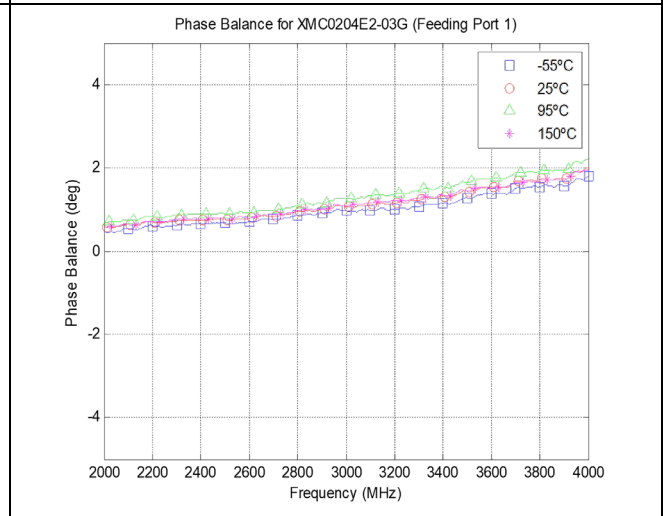
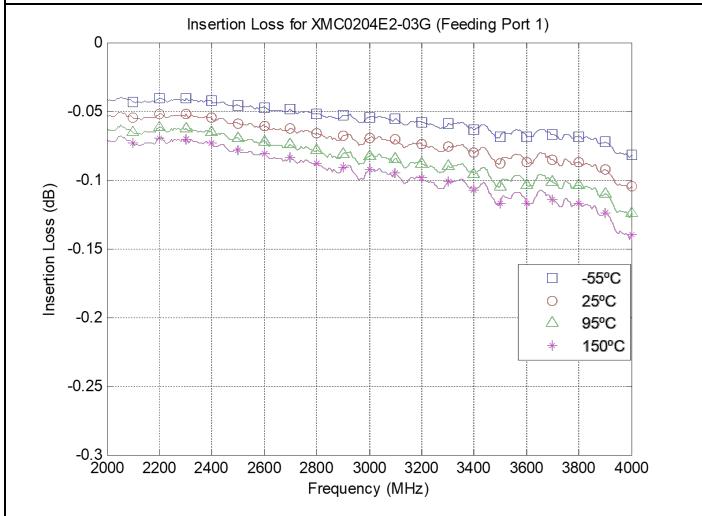
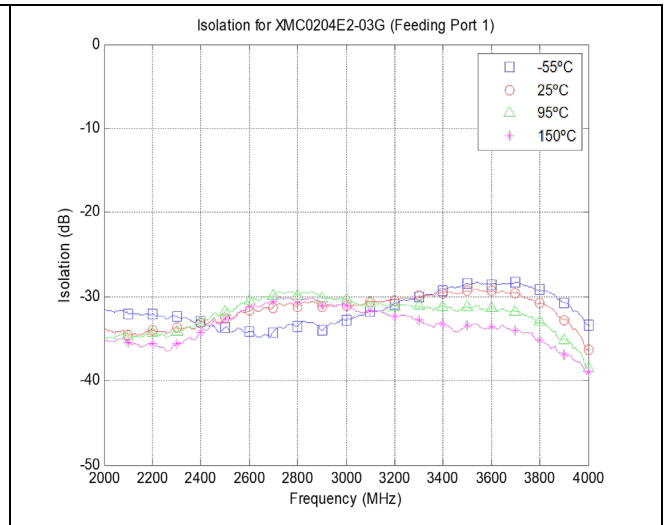
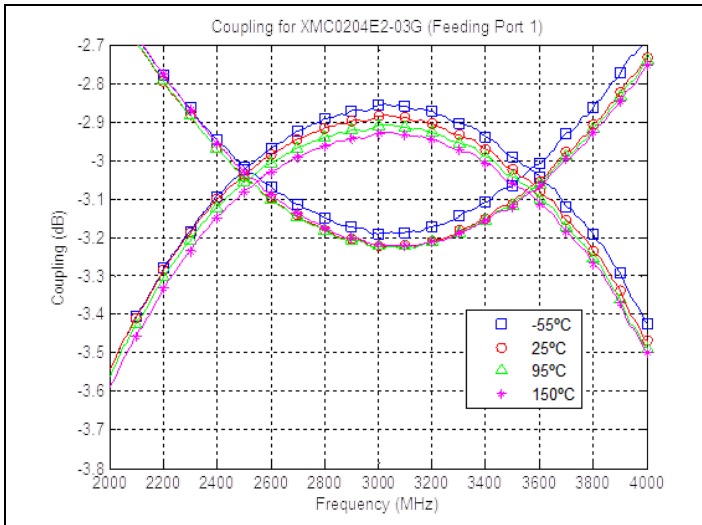

## Definition of Measured Specifications

Parameter	Definition	Mathematical Representation
<b>VSWR</b> (Voltage Standing Wave Ratio)	The impedance match of the coupler to a 50Ω system. A VSWR of 1:1 is optimal.	$VSWR = \frac{V_{max}}{V_{min}}$ Vmax = voltage maxima of a standing wave Vmin = voltage minima of a standing wave
<b>Return Loss</b>	The impedance match of the coupler to a 50Ω system. Return Loss is an alternate means to express VSWR.	$\text{Return Loss(dB)} = 20 \log \frac{VSWR + 1}{VSWR - 1}$
<b>Insertion Loss</b>	The input power divided by the sum of the power at the two output ports.	$\text{Insertion Loss(dB)} = 10 \log \frac{P_{in}}{P_{cpl} + P_{direct}}$
<b>Isolation</b>	The input power divided by the power at the isolated port.	$\text{Isolation(dB)} = 10 \log \frac{P_{in}}{P_{iso}}$
<b>Phase Balance</b>	The difference in phase angle between the two output ports.	Phase at coupled port – Phase at direct port
<b>Amplitude Balance</b>	The power at each output divided by the average power of the two outputs.	$10 \log \frac{P_{cpl}}{(P_{cpl} + P_{direct})/2} \text{ and } 10 \log \frac{P_{direct}}{(P_{cpl} + P_{direct})/2}$

**Packaging and Ordering Information:**

Parts are available in a reel. Packaging follows EIA 481-D for reels. 250 or 2000 Parts are oriented in tape and reel as shown below.

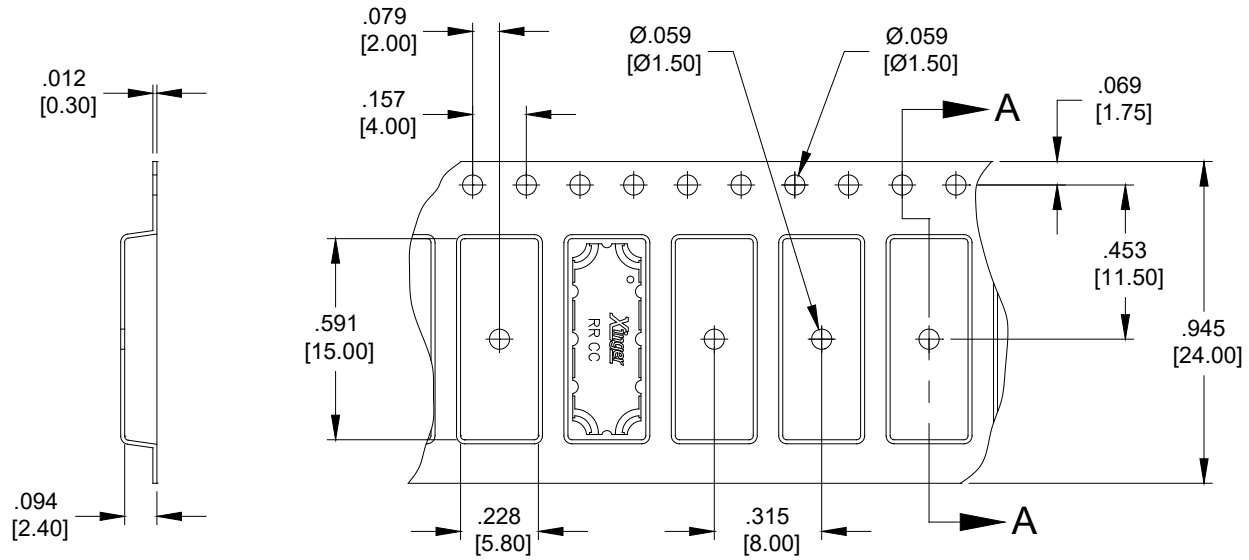

SECTION A-A

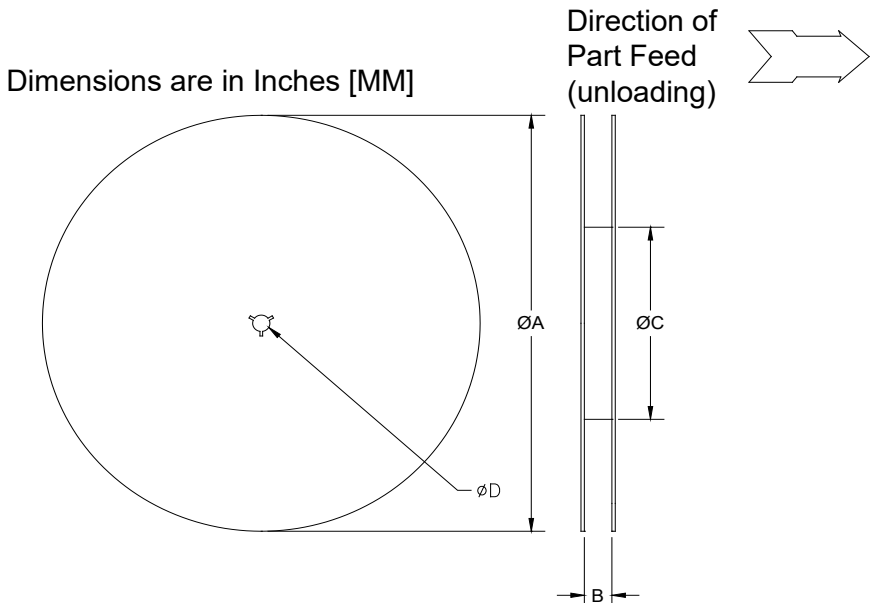

TABLE 1. REEL DIMENSIONS					
	QUANTITY/REEL	ØA	B	ØC	ØD
XMC0204E2-03GR	2000	330.00	24.0	102.03	13.00
XMC0204E2-03GR1	250	177.80	24.0	50.80	13.00

Contact us:  
[rf&s\\_support@ttm.com](mailto:rf&s_support@ttm.com)

# Mouser Electronics

Authorized Distributor

Click to View Pricing, Inventory, Delivery & Lifecycle Information:

[TTM Technologies:](#)

[XMC0204E2-03G](#)