

# Xinger®

## Ultra Low Profile 0404 Balun 50Ω to 150Ω Balanced

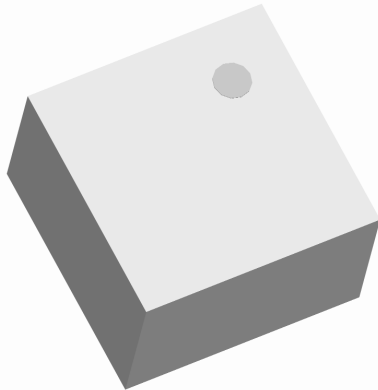

### Description

The BD4859N50150AHF is a low cost, low profile sub-miniature unbalanced to balanced transformer designed for differential inputs and output locations on modern chipsets in an easy to use surface mount package covering 802.11a Uni-Band II & III and the Japanese ISM band (4.9 GHz). The BD4859N50150AHF is ideal for high volume manufacturing and delivers higher performance than traditional ceramic baluns. The BD4859N50150AHF has an unbalanced port impedance of 50Ω and a 150Ω balanced port impedance. This transformation enables single ended signals to be applied to differential ports on modern integrated chipsets. The output ports have equal amplitude (-3dB) with 180 degree phase differential. The BD4859N50150AHF is available on tape and reel for pick and place high volume manufacturing.

### Detailed Electrical Specifications: Specifications subject to change without notice.

Features:	Parameter	ROOM (25°C)			Unit
		Min.	Typ.	Max	
<ul style="list-style-type: none"> <li>• 4800 – 5900 MHz</li> <li>• 0.56 mm Height Profile</li> <li>• 50 Ohm to 2 x 75 Ohm</li> <li>• Low Insertion Loss</li> <li>• 802.11a Uni-Band II &amp; III</li> <li>• Home Cordless Compliant</li> <li>• Surface Mountable</li> <li>• Tape &amp; Reel</li> <li>• Non-conductive Surface</li> <li>• RoHS Compliant</li> <li>• Halogen Free</li> </ul>	Frequency	4800		5900	MHz
	Unbalanced Port Impedance		50		Ω
	Balanced Port Impedance		150		Ω
	Return Loss	12	17		dB
	Insertion Loss*		0.4	0.6	dB
	Amplitude Balance		0.8	1.4	dB
	Phase Balance		4	10	Degrees
	CMRR		26		dB
	Power Handling			1.0	Watts
	Operating Temperature	-55		+85	°C

\* Insertion Loss stated at room temperature (Insertion Loss is approximately 0.1 dB higher at +85 °C)

### Outline Drawing

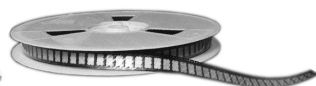
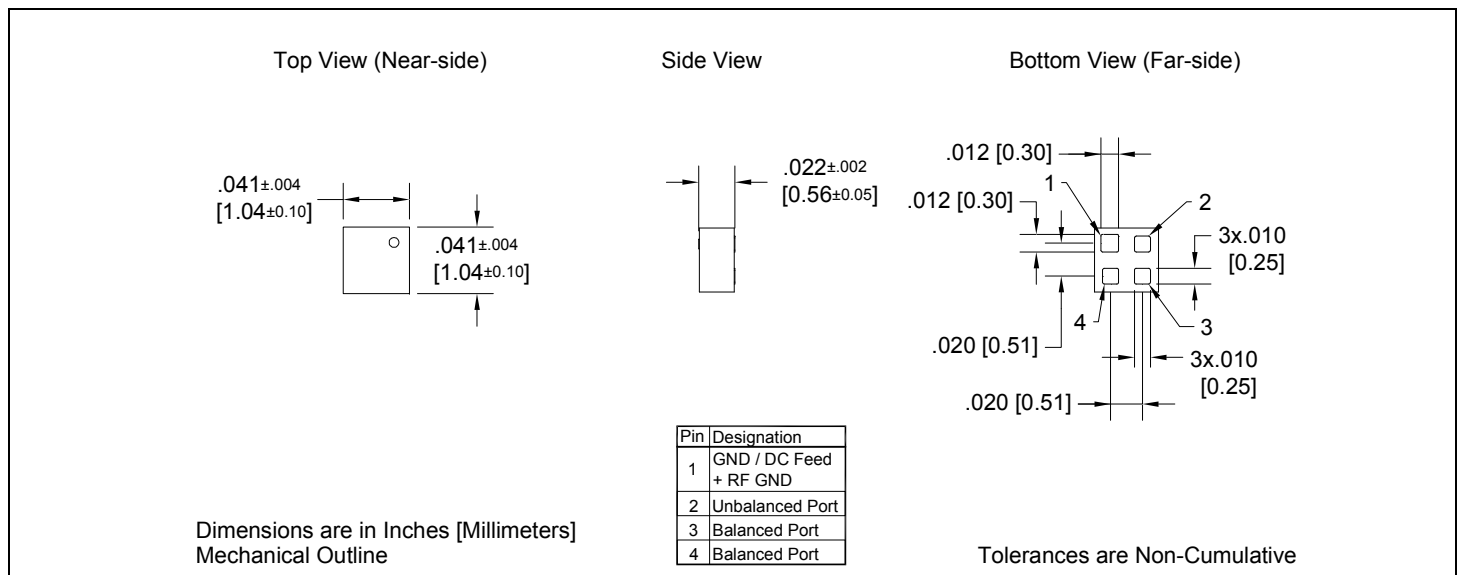

## Typical Performance: 4700 MHz. to 6000 MHz.

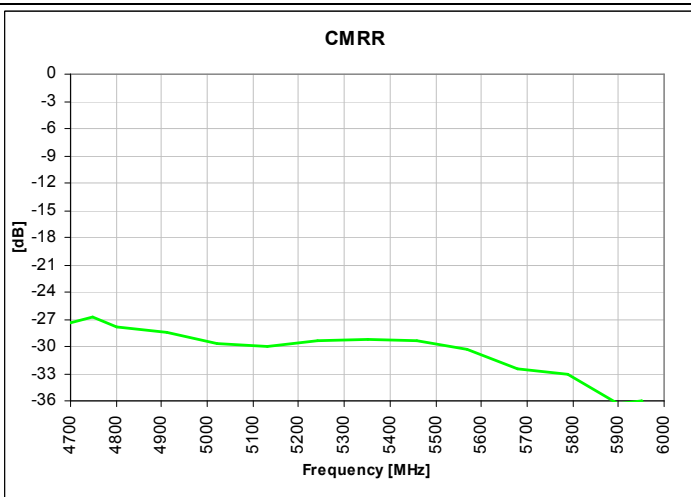
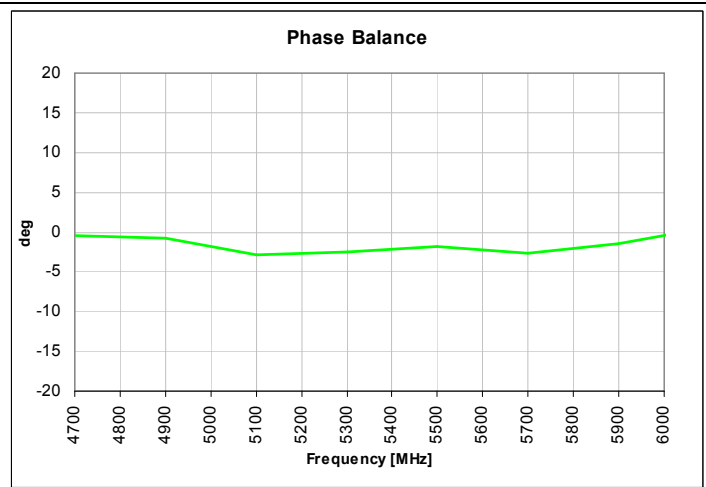
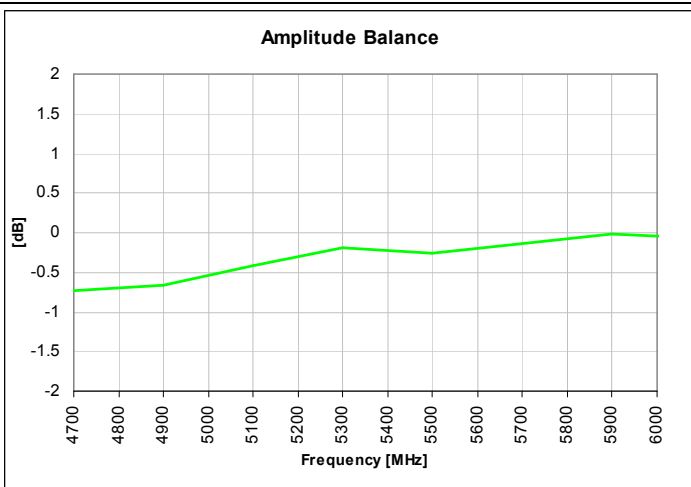
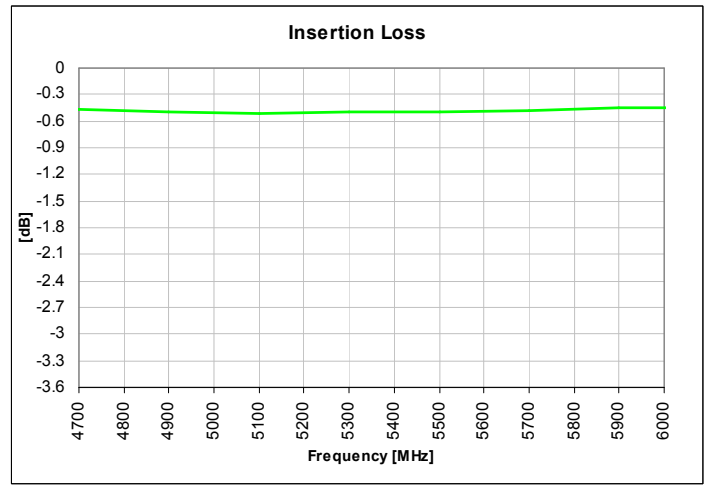
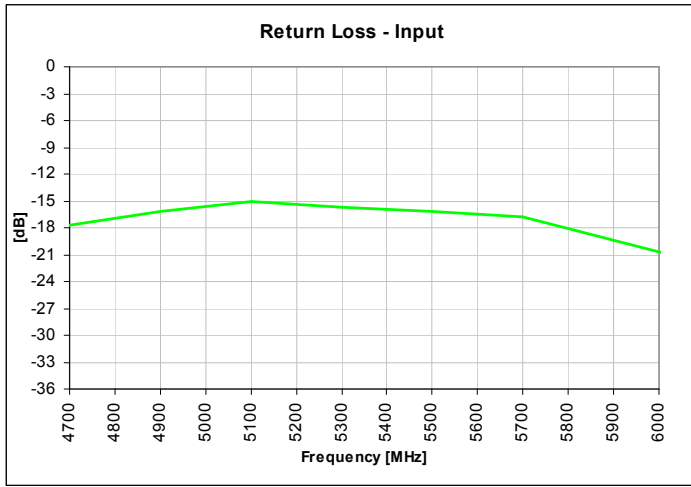

USA/Canada: (315) 432-8909  
 Toll Free: (800) 411-6596  
 Europe: +44 2392-232392

Available on Tape and Reel for Pick and Place Manufacturing.

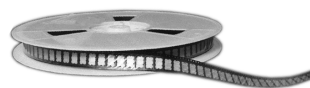

**Anaren**  
 What'll we think of next?™

### Wide Band Performance: 500 MHz. to 8500 MHz.

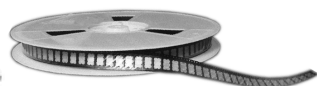
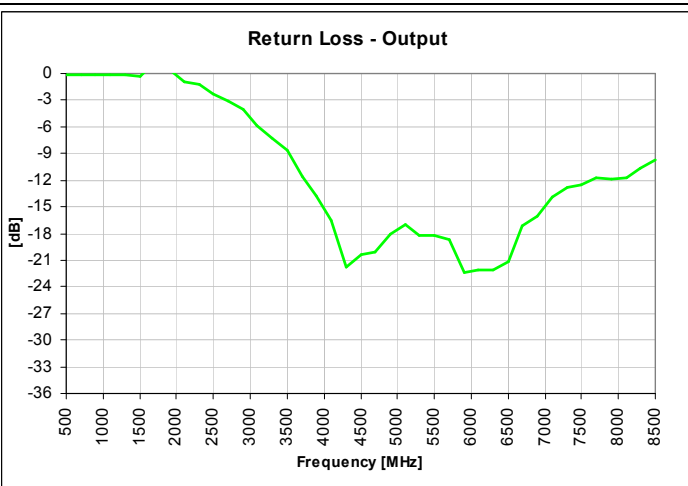
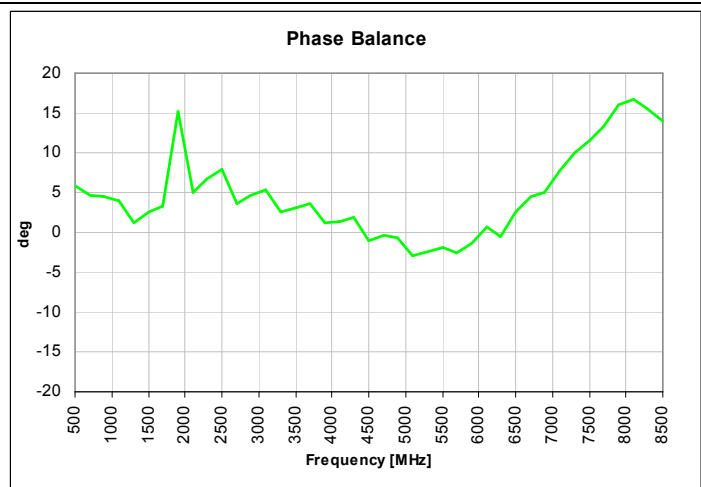
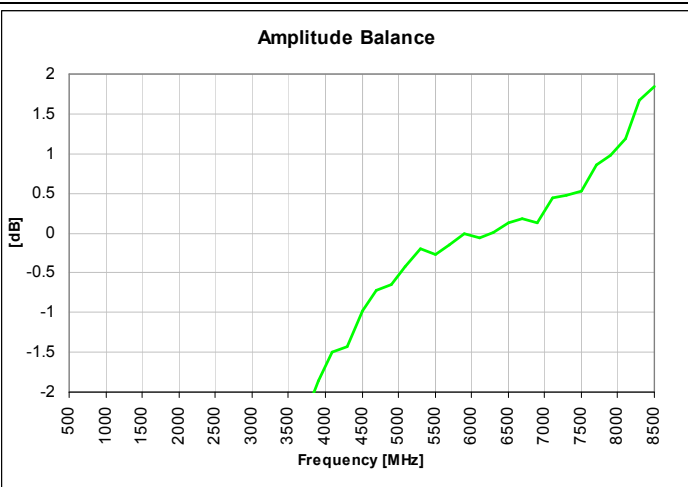
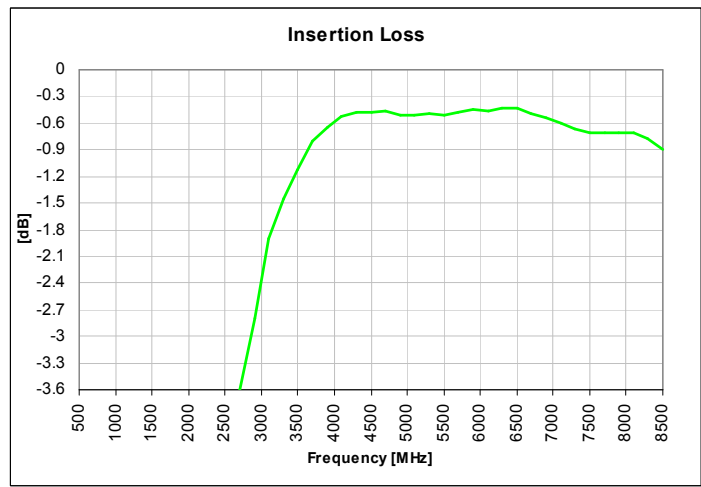
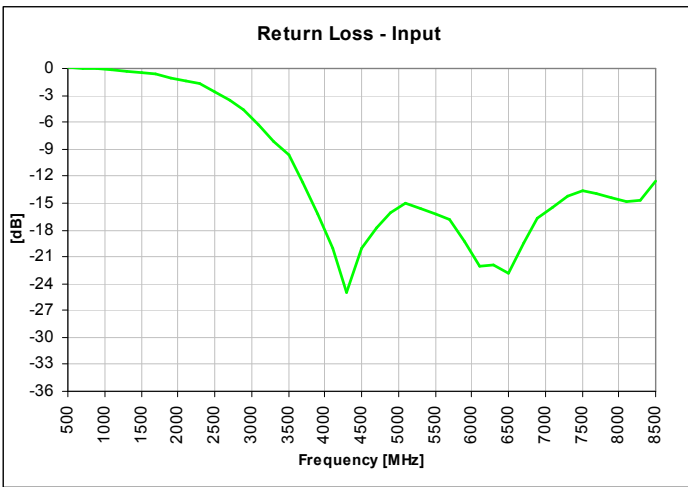

**Mounting Configuration:**

In order for Xinger surface mount components to work optimally, the proper impedance transmission lines must be used to connect to the RF ports. If this condition is not satisfied, insertion loss, Isolation and VSWR may not meet published specifications.

All of the Xinger components are constructed from ceramic filled PTFE composites which possess excellent electrical and mechanical stability having X and Y thermal coefficient of expansion (CTE) of 17 ppm/°C.

An example of the PCB footprint used in the testing of these parts is shown below. An example of a DC-biased footprint is also shown below. In specific designs, the transmission line widths need to be adjusted to the unique dielectric coefficients and thicknesses as well as varying pick and place equipment tolerances

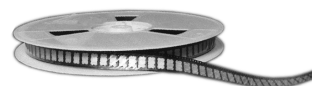
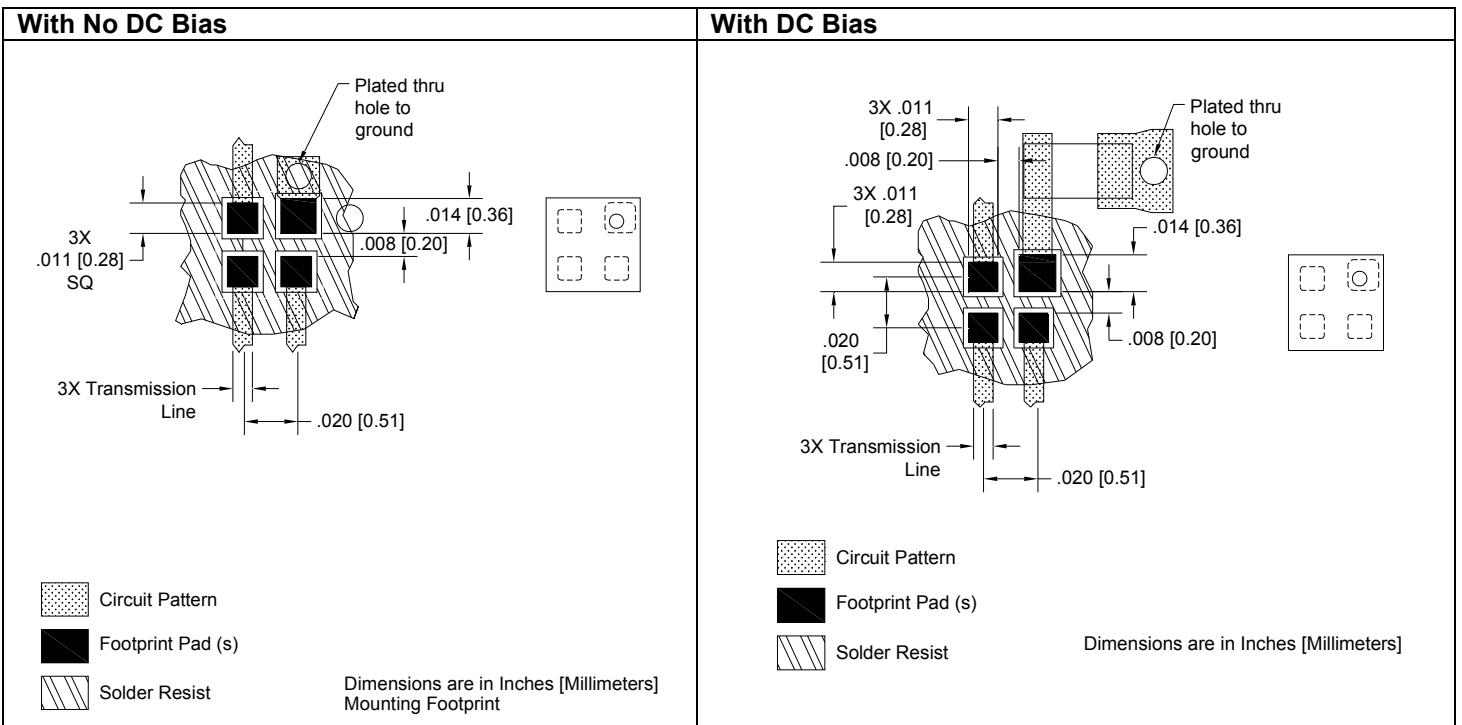

### Packaging and Ordering Information

Parts are available in reel and are packaged per EIA 481-2. Parts are oriented in tape and reel as shown below. Minimum order quantities are 4000 per reel. See Model Numbers below for further ordering information.

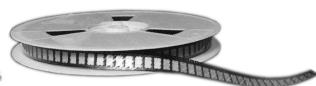
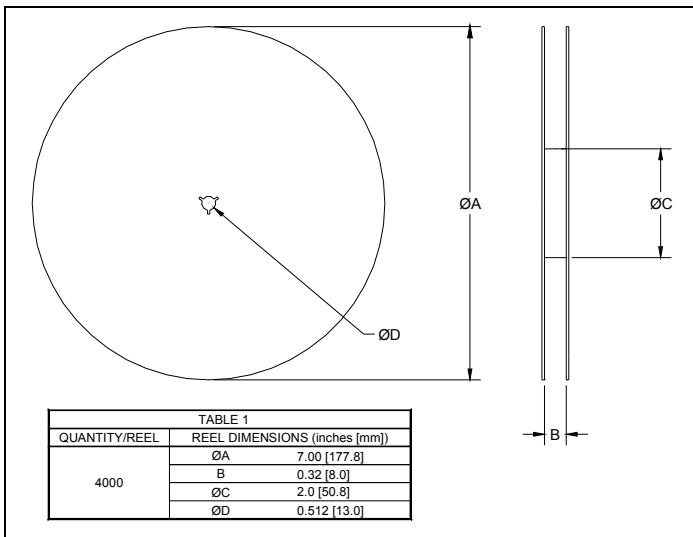
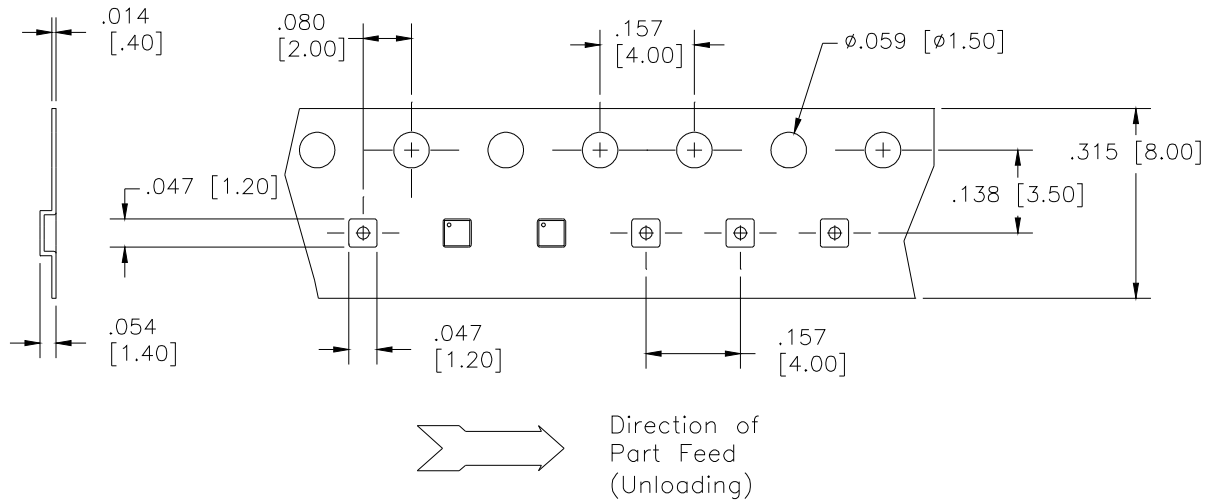

# Mouser Electronics

Authorized Distributor

Click to View Pricing, Inventory, Delivery & Lifecycle Information:

[Anaren:](#)

[BD4859N50150AHF](#)