

## XENSIV™ TLE4973 Current sensor 2GO kit User Guide

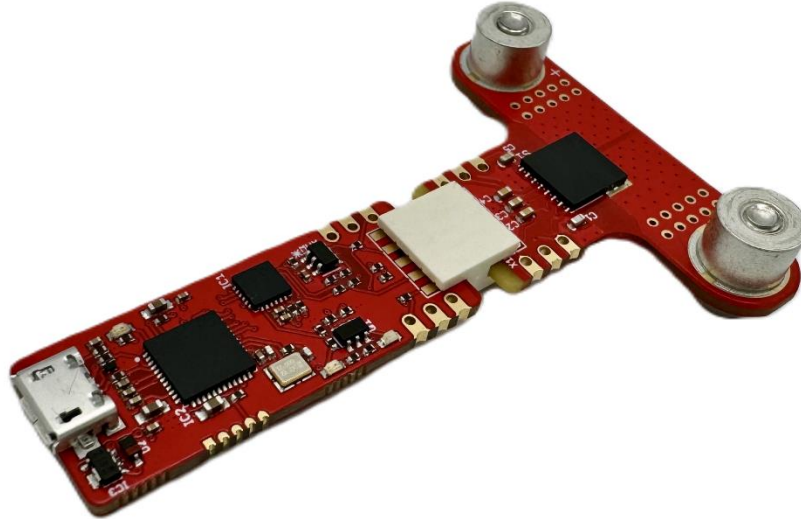

### About this document

#### Scope and purpose

Infineon's Current sensor 2Go kit is a low-cost solution which enables the user to quickly evaluate the TLE4973 current sensor.

The following key aspects are discussed in this document.

- Sensor board description & schematic
- MCU board description & schematic
- Current sensor 2Go kit GUI description & installation procedure
- Current sensor 2Go kit use cases
- Reprogramming the EEPROM of TLE4973

The programmer board is to be used by the customer solely for the purpose of evaluation and testing. It is not a commercialized product and shall not be used for series production. The programmer board is thus not intended to meet any industrial specifications and must be operated in the room temperature conditions.

Due to the purpose of the system, it is not subject to the same procedures regarding Returned Material Analysis (RMA), Process Change Notification (PCN) and Product Withdraw (PWD) as regular products.

#### Intended audience

Current Sensor Module Developers

Inverter/Converter applications

Industrial Drive applications

### Table of contents

## Table of contents

<b>About this document</b> .....	<b>1</b>
<b>Table of contents</b> .....	<b>2</b>
<b>Disclaimer &amp; Safety precautions</b> .....	<b>3</b>
<b>1 Introduction</b> .....	<b>4</b>
Getting started .....	4
1.1 Kit Content.....	4
1.2 Use Cases.....	5
1.3 Features .....	5
1.4 Hardware and Software Overview.....	6
1.4.1 Hardware Overview.....	6
1.4.2 Software Overview .....	7
1.5 Software Installation.....	7
1.5.1 Requirements.....	7
1.5.2 Software download.....	7
1.5.3 Installing the software .....	8
1.5.4 Uninstalling the software.....	10
<b>2 TLE4973_MS2GO kit Description</b> .....	<b>11</b>
2.1 Sensor Board .....	11
2.1.1 Overview.....	11
2.1.2 Hardware Design.....	11
2.1.3 PCB Layout .....	12
2.1.4 Bill of Materials.....	13
2.2 MCU Board.....	13
2.2.1 Overview.....	13
2.2.2 Hardware Design.....	14
2.2.3 PCB Layout .....	17
2.2.4 Bill of Materials.....	18
2.3 In-Plane Edge Connector .....	19
<b>3 Current Sensor 2GO Evaluation Software</b> .....	<b>20</b>
3.1 Safety precautions .....	20
3.2 Overview .....	20
3.3 Startup Screen and Connecting to the Programmer .....	20
3.4 Main Window and Graphical Elements.....	21
3.4.1 Sensor Readout and Data Logging.....	21
3.4.2 ADC data processing .....	23
3.4.3 EEPROM Map and configuration.....	24
<b>4 Appendix I – Hardware Revision History</b> .....	<b>26</b>
<b>5 Glossary</b> .....	<b>27</b>
<b>6 References</b> .....	<b>28</b>
<b>Revision history</b> .....	<b>29</b>

User Guide







Disclaimer & Safety precautions

Disclaimer & Safety precautions

Please read & understand the MS2GO manual and the following safety precautions

The MS2GO board is a sample to be used by the customer solely for the purpose of evaluation and testing. It is not meant for commercial usage and shall not be used for series production. The MS2GO board is thus not intended to meet any industrial qualifications. As like regular products, Returned Material Analysis (RMA), Process Change Notification (PCN) and Product Withdraw (PWD) is not applicable with this product. See Legal Disclaimer and Warnings for further restrictions on Infineon Technologies warranty and liability.

Safety precautions

	<p><b>Attention:</b> The sensor device on the board provides only functional isolation. As Infineon does not provide any isolation to protect human life against hazards caused by high voltage, an additional isolation is required while accessing the high voltage nodes on the MS2GO Board to protect the user. Failure to comply may result in personal injury, death and/or equipment damage.</p>
	<p><b>Attention:</b> The customer assumes all responsibility and liability for its correct handling and/or use of the MS2GO Board. Also the customer undertakes to indemnify and hold the Infineon Technologies harmless from any third party claim in connection with or arising out of the use and/or handling of the MS2GO Board.</p>
	<p><b>Attention:</b> As MS2GO board operates with high voltages, the personnel familiar with high voltage power electronics and machinery applications should plan to implement the installation, start-up and subsequence maintenance of the MS2GO board in a high voltage environment. Failure to comply may result in personal injury, death and/or equipment damage.</p>
	<p><b>Attention:</b> The sensor on the MS2GO Board may become hot during operation. The board is not intended to carry high current (maximum 20A<sub>DC</sub> continuously) without additional cooling or heat sinks. Hence, the necessary precautions are required. Failure to comply may result in personal injury, death and/or equipment damage.</p>
	<p><b>Attention:</b> An over load or incorrectly installed setup can damage MS2GO board permanently or reduction in lifetime. Also, unpremeditated high current, high voltage or excessive ambient temperature may result in system malfunction.</p>
	<p><b>Attention:</b> MS2GO board parts and assemblies are sensitive to Electrostatic Discharge (ESD). MS2GO board components may get damaged if ESD control procedures are not followed when installing, testing, servicing or repairing the MS2GO board. If you are not familiar with electrostatic control procedures, refer to applicable ESD protection handbooks and guidelines.</p>

## 1 Introduction

The TLE4973 Current sensor 2Go kit is a budget-priced evaluation kit enabling the possibility to evaluate the Infineon TLE4973 current sensor.

### Getting started

The following chapters describe the different parts of the TLE4973\_MS2GO kit, hardware connection, software installation and clarifies how to use the graphical user interface (GUI) in order to perform the first evaluation of the sensor in a particular application. The TLE4973\_MS2GO kit shall be used at low voltages, as instructed in the safety precautions chapter. The current sensor provides galvanic isolation. Please consider the safety precautions for high voltage applications as described in the enclosed disclaimer document provided with the delivered sensor kit.

#### 1.1 Kit Content

The TLE4973\_MS2GO kit contains the following components in its order package.

- Sensor board (equipped with M4 screw connectors for high current capabilities), built in thick copper technology (140µm copper / dual layer).
- MCU board equipped with XMC1100 as target microcontroller and XMC4200 as debugger microcontroller. This board implements the application circuit of the sensor.
- Zip lock bag with 2xM4 screws and one PCB edge connector (for connecting the sensor board to MCU board).
- Disclaimer for safety precautions.

**Figure 1** depicts the content of the TLE4973\_MS2GO kit. Please note that this picture is generic, and the latest variant might suffer modifications.



**Figure 1** TLE4973 Current sensor 2GO Kit

**Table 1** Order Information

TLE4973_MS2GO	SP006039680
---------------	-------------

## 1.2 Use Cases

The TLE4973\_MS2GO kit can be used for different use cases as shown below.

- TLE4973\_MS2GO kit use case with MCU Board + connection to computer running Windows 7 or higher.
- Sensor board alone.

The TLE4973\_MS2GO kit can be used as an independent evaluation kit by connecting the sensor board together with MCU board. The user must connect the XMC2GO board with the PC/Laptop using the USB cable, which must have micro-USB on one side and standard USB port on the other side of the cable. The provided GUI is plug & play.

The sensor board can also be used as standalone in any customer application (e.g. Interfaced with custom MCU platforms, and lab equipment etc.). M4 screws are used to connect the primary current source.

## 1.3 Features

The following section describes the main features of the TLE4973\_MS2GO evaluation kit:

- USB Interface.
- Supply via USB cable.
- Oscilloscope functionality: Real-time roll-mode.
- Support for all TLE4973 different output modes.
- EEPROM programming support.
- Automatic detection of a sensor board.

## User Guide

### Introduction

## 1.4 Hardware and Software Overview

### 1.4.1 Hardware Overview

The TLE4973\_MS2GO kit contains the following items:

- In-plane edge interface connector.
- MCU Board.
- Sensor board.
- USB Cable.
- Disclaimer and Safety precautions document.

Figure 2 depicts the assembled TLE4973\_MS2GO kit with associated pin labels.

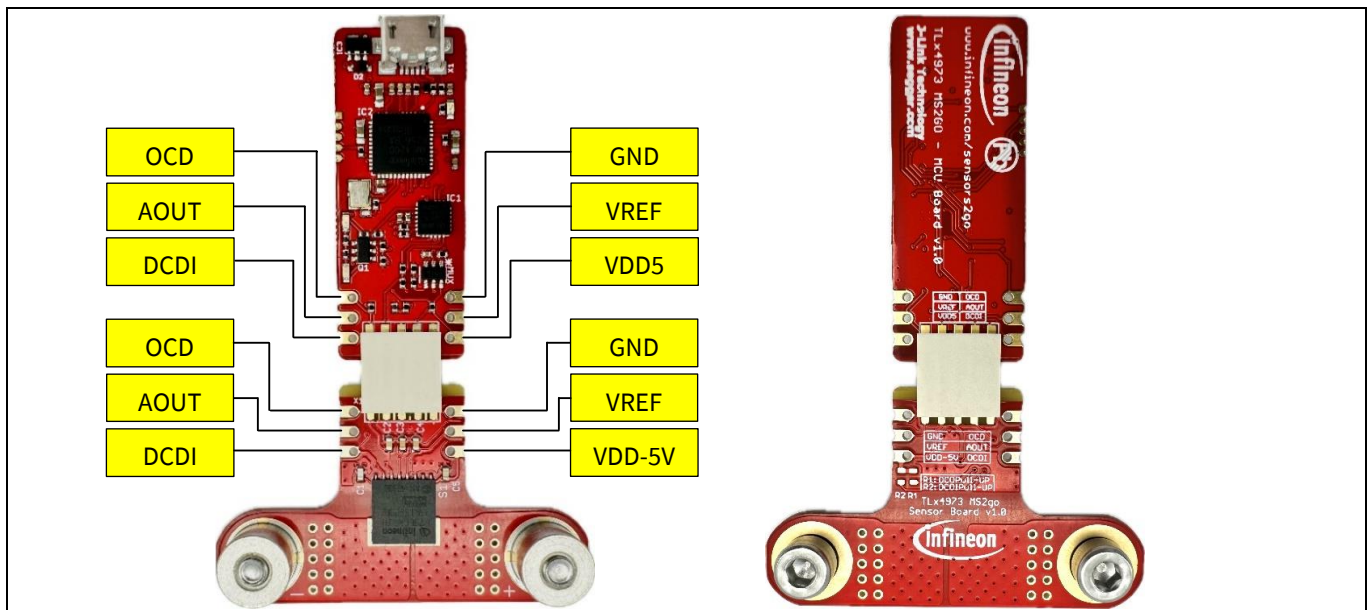

Figure 2 TLE4973 Current sensor 2GO Kit: Assembled components

Figure 3 depicts the individual hardware components of the TLE4973\_MS2GO kit.

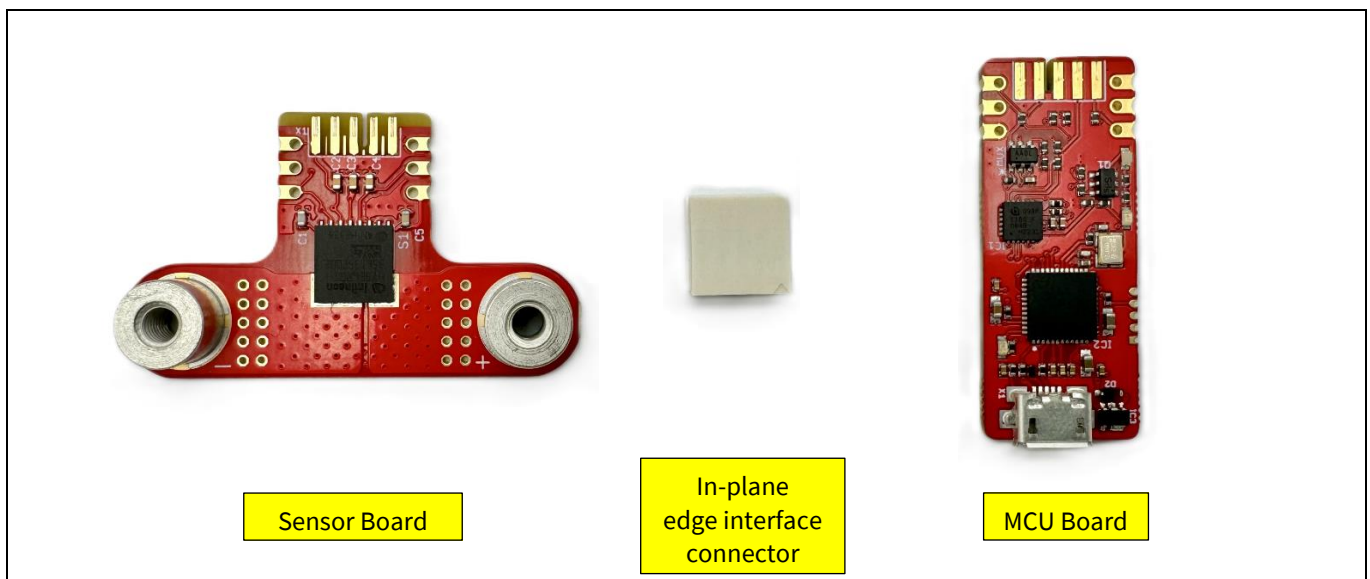

Figure 3 TLE4973 Current sensor 2GO Kit: Individual components

## User Guide

### Introduction

#### 1.4.2 Software Overview

Please download the required software from Infineon website. For further information about the software installation please refer to the Section 1.5.

The software package contains:

- A Graphical User Interface (GUI) software for the sensor evaluation.
- SEGGER Jlink debugger software with USB driver.

#### 1.5 Software Installation

The following subsections consist of a guide through the installation procedure of the free evaluation software for the TLE4973\_MS2GO kit.

##### 1.5.1 Requirements

The TLE4973\_MS2GO hardware and software bundle was developed and tested on the following PC configuration:

- Operating system: Windows 10 / Windows 11 (also compatible with Windows 7)
- RAM: 8 GB (maximum RAM usage estimated at 250 MB, when data logging is ON)
- Storage: 512 GB (minimum required for installation: 250 MB, including dependencies)
- CPU: 3 GHz, 4 cores (lower performance CPUs might have an impact on the performance of the graphical user interface)

##### 1.5.2 Software download

The graphical user interface software is offered free-of-charge on our website, via the [Infineon Development Center](#) online platform, section tools, or from the Infineon Developer Center Launcher application. The user may filter the tool list by inserting the text “TLE4973” or “Current Sensor” and the following record shall appear: **XENSIV™ Current Sensors MS2Go Evaluation App**.

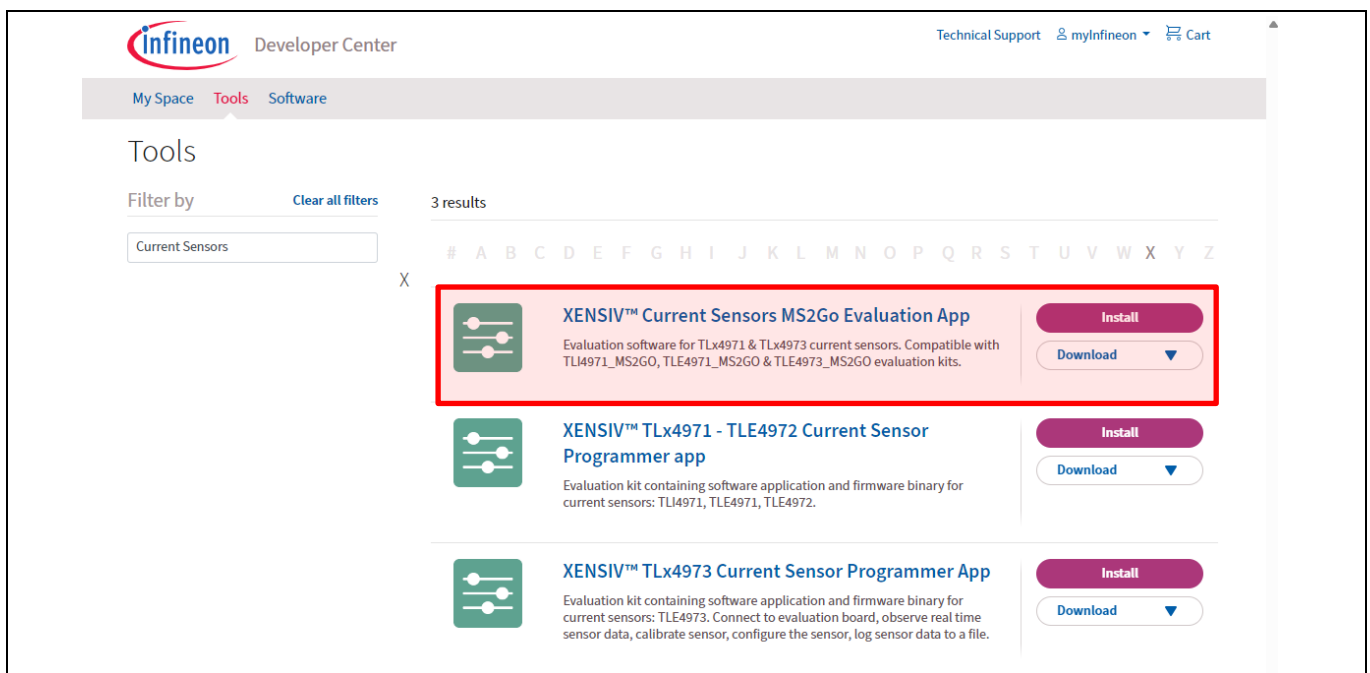

Figure 4 Infineon Development Center – online tools filtering

## User Guide

### Introduction

It is highly advised to install the [Infineon Developer Center Launcher](#) application prior to installing the above-mentioned app.

Please note that the download of the XENSIV™ Current Sensors MS2Go Evaluation App is open only for users registered with a MyInfineon Account.

### 1.5.3 Installing the software

Download the XENSIV™ Current Sensors MS2Go Evaluation App from Infineon Website or from Infineon Developer Center Launcher. Install the Evaluation Kit software by double clicking on the installer file. Please notice that administrator rights are required. The installer file contains the following elements:

- Binaries / compiled objects needed for running the graphical user interface.
- SEGGER Jlink debugger software with USB driver.
- .NET 4.8 online installer (needed only for older versions of Windows which do not have this already installed). Installation requires stable internet connection.

Installation steps:

- License agreement It is required that you agree with Infineon Terms and Conditions before continuing.

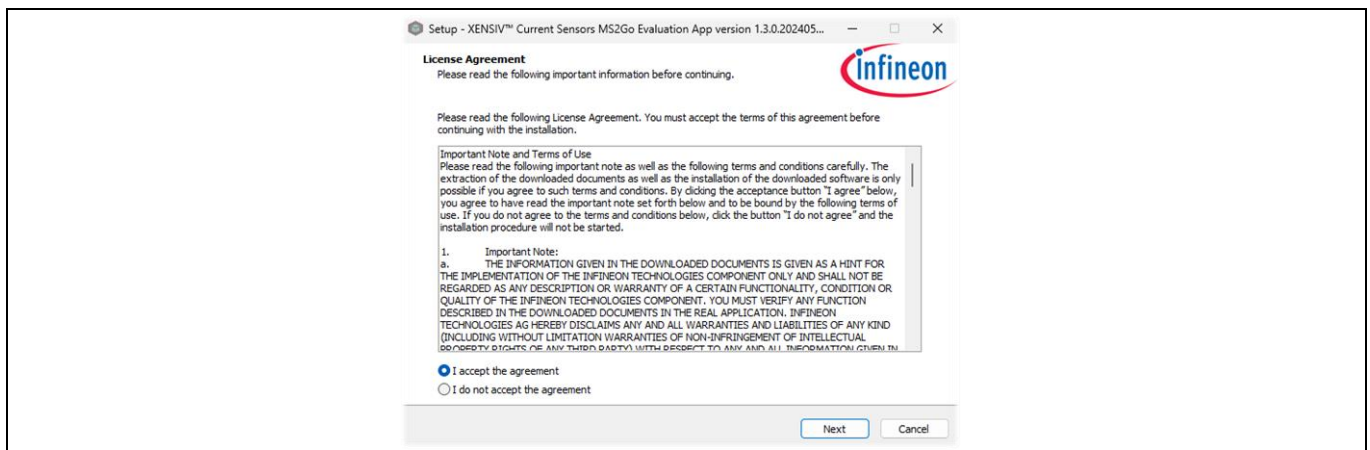

**Figure 5 Software Installation Step – License Agreement**

- Installation type selection. We recommend using the Quick Installation type. After pressing “Install” the installation process will start.

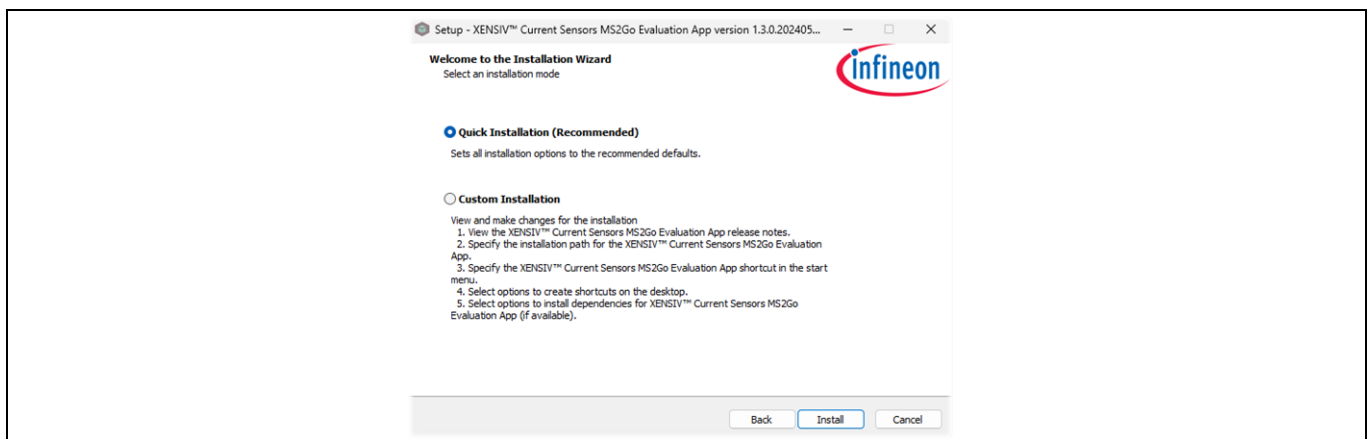

**Figure 6 Software Installation Step – Quick Installation**



## User Guide

### Introduction

- After the binaries are copied to the installation folder, the user is prompted for installing JLink Segger Driver. If this is already installed on your PC the user can cancel this operation. Please note that by not having this driver installed, the USB connection between PC and the TLE4973\_MS2GO kit MCU board will not function.



**Figure 7 Software Installation Step – Segger J-Link Driver Installation**

- After the SEGGER JLink driver is installed or the operation is cancelled, the user is prompted for installing .NET Framework 4.8. Please note that for operating systems starting from Windows 10, build 1903 this comes pre-installed, and the user is notified that the required package is already installed. If the framework is not already installed, the user shall make sure that an internet connection is in place in order to complete the installation process.

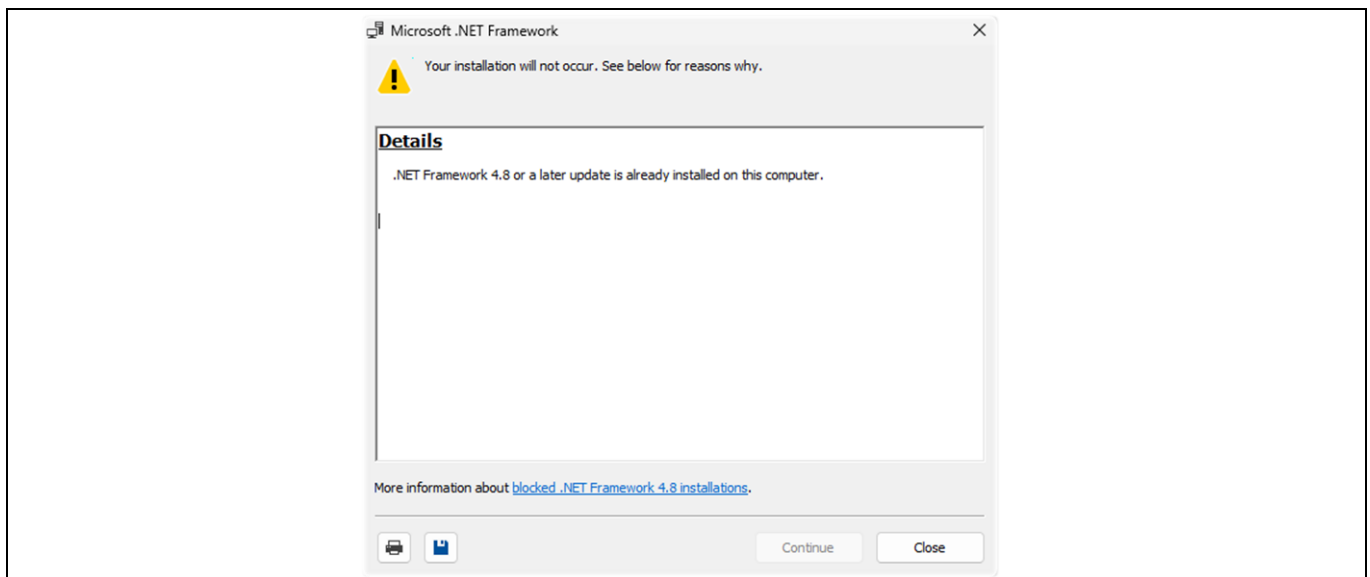
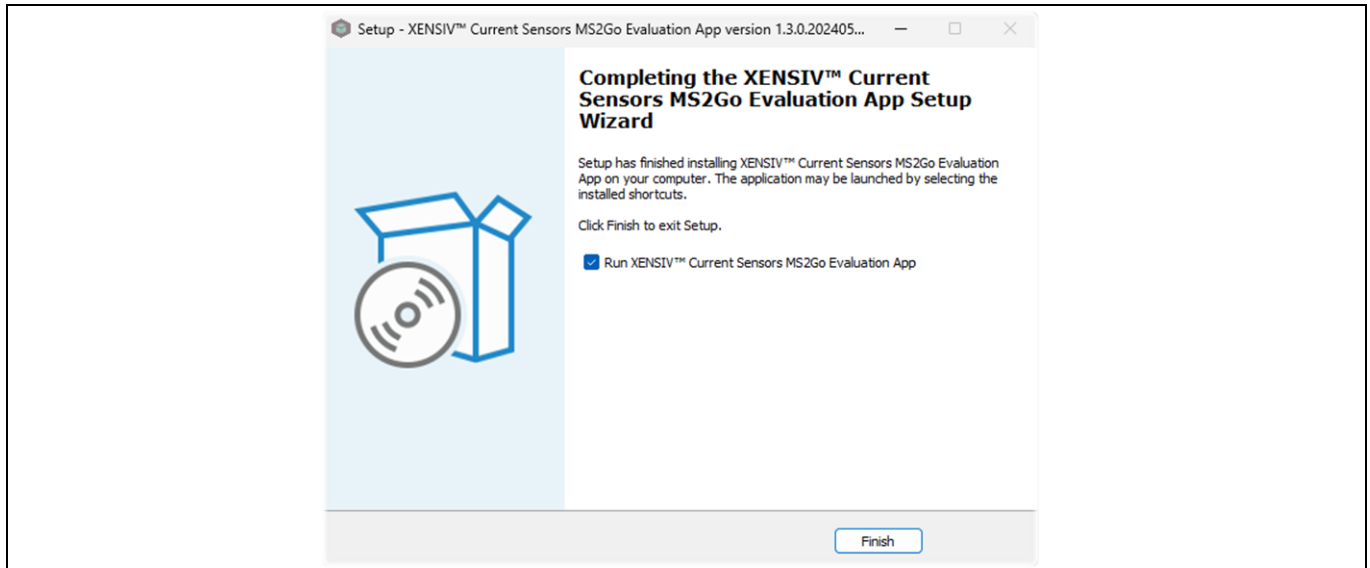

**Figure 8 Software Installation Step – .NET 4.8 Installation**

## User Guide

### Introduction

- The user is notified upon completion of all installer processes and a shortcut is by default created on Desktop. The user may opt for running the installed **XENSIV™ Current Sensors MS2Go Evaluation App**.



**Figure 9** Software Installation Step – Completion

### 1.5.4 Uninstalling the software

To uninstall the software package, go to “Start” -> “Add or remove programs” and search for the **XENSIV™ Current Sensors MS2Go Evaluation App** (or the term “Current”). Press “Uninstall” for deleting the software from your PC.

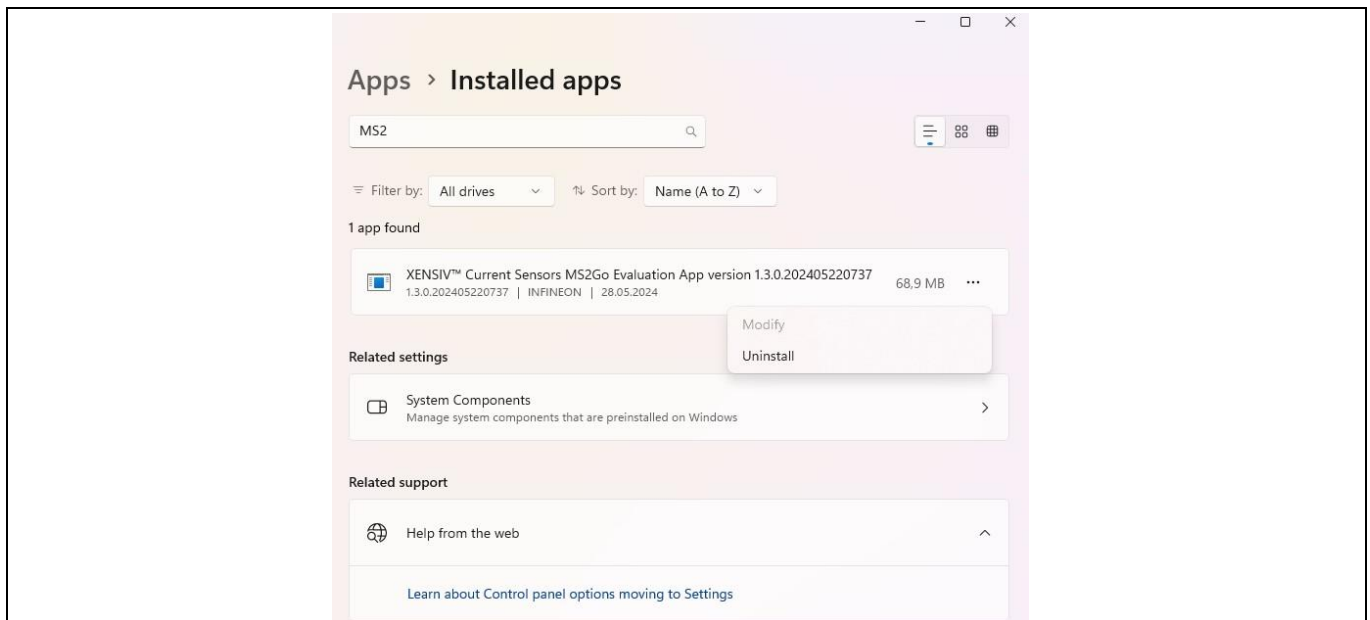

**Figure 10** Software Installation Step – Uninstall

All Installation files are deleted from the system except:

- Segger JLink driver, which if needed, can be uninstalled separately.
- .NET 4.8 dependencies, which on most cases are part of the operating system.

## 2 TLE4973\_MS2GO kit Description

The TLE4973\_MS2GO kit contains the following main components:

- Sensor board
- MCU Board
- In-plane edge connector

### 2.1 Sensor Board

#### 2.1.1 Overview

The current sensor is placed on a board with two M4 screw connectors for high current ( $\leq 20A$ ) applications. The PCB is manufactured in 140  $\mu m$  copper technology, and the sensor provides functional galvanic isolation. The sensor inputs/outputs are easily accessible via 2 x 3 pole pin headers with 2.54mm pitch (**Figure 11**). The sensor board implements the application circuit of the device, and its schematic design, layout details and assembly bill of materials are presented in the next sections.

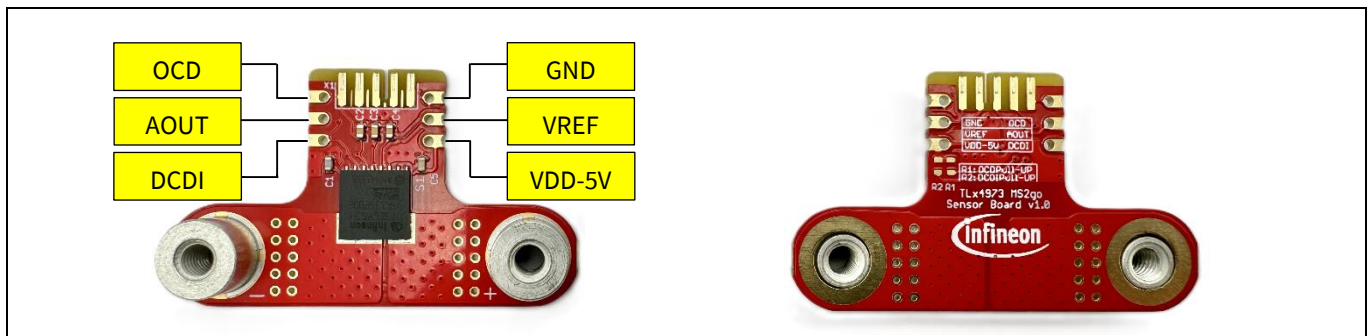

**Figure 11** Sensor Board Top and Bottom View

#### 2.1.2 Hardware Design

This section offers a detailed description on the latest hardware design version of the TLE4973\_MS2GO Sensor board, version V1.0.

The hardware is composed of the following main blocks:

- **Sensor under evaluation** [S1] with required passive components [C1-5].
- **Pull-up resistors for DCDI and OCD lines** [R1, R2]: default not assembled, only for standalone use of the sensor board.
- **Edge connector** [X1]: to establish the connection with the MCU board.
- **M4 screw connectors** [U11, U12]: used to connect the primary current source.
- **Auxiliary connectors:** PCB side connectors (JP1, JP2 – 2.54mm headers, default not assembled).

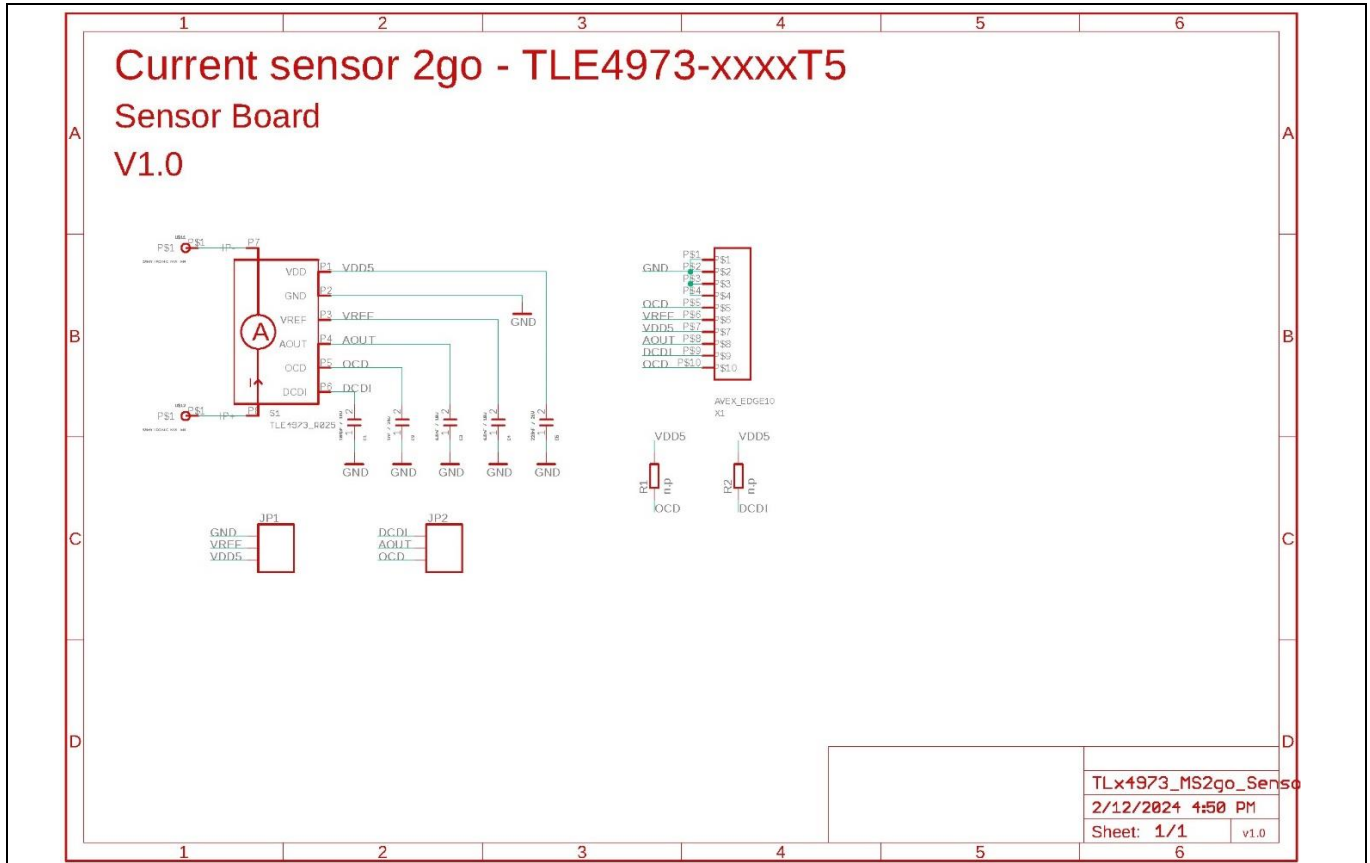

Figure 12 Sensor Board Schematic Design

### 2.1.3 PCB Layout

The design described in sections 2.1.1 and 2.1.2 is physically implemented in PCB technology using a standard process with following characteristics:

- PCB material: FR4.
- Copper: 2 layers Top/Bottom, 140µm thickness each.
- 45-degree chamfer on connector side.

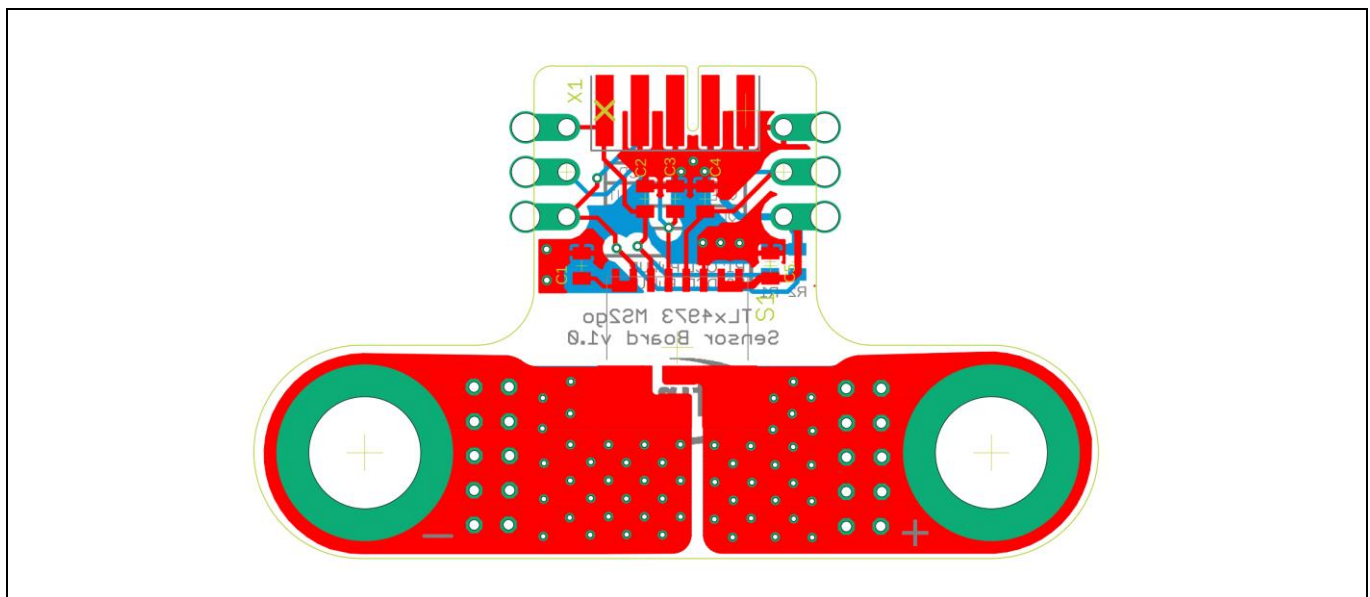

Figure 13 Sensor Board PCB Layout

## User Guide

### TLE4973\_MS2GO kit Description

#### 2.1.4 Bill of Materials

**Table 2 TLE4973\_MS2GO kit Sensor Board bill of materials**

Designator	Description	Quantity	Assembled on PCB	Infineon Part
JP1, JP2	PINHD_1X3_S2GO	2	NO	NO
C1	100pF 0603 10V	1	YES	NO
C2	1nF 0603 25V	1	YES	NO
C5	220nF 0603 25V	1	YES	NO
C3, C4	6.8nF 0603 10V	2	YES	NO
X1	AVEX_EDGE10 In-plane Edge Connector	1	YES (included in the package)	NO
U\$11, U\$12	SAMYTRONIC_NUT_M4	2	YES	NO
S1	<b>TLE4973_R025T5-S0010</b> <b>(Evaluated Sensor)</b>	1	YES	<b>YES</b>
R1, R2	n.p.	2	<b>NO</b>	NO
M4 Screws		2	YES (included in the package)	NO

## 2.2 MCU Board

### 2.2.1 Overview

The micro controller unit (MCU) board can be connected directly to sensor board in order to obtain a plug & play evaluation system. The MCU board contains:

- One XMC4200 microcontroller running a SEGGER Jlink license for debugging.
- One XMC1100 microcontroller used as target MCU.
- MAX4624EUT / STG719STR Analog MUX is used to select an external or internal sensor voltage reference.

The microcontroller 12-bit ADC sensor reads the analog output / reference signal. This board is connected with an in-plane edge connector to the sensor board.

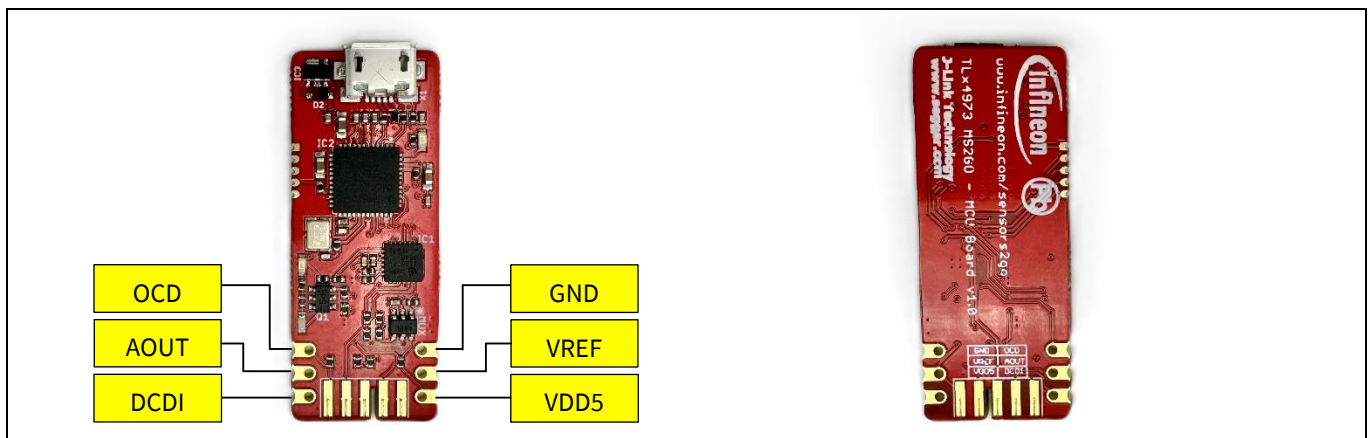

**Figure 14 MCU Board Top and Bottom View**

## 2.2.2 Hardware Design

This section offers a detailed description on the latest hardware design version of the TLE4973\_MS2GO MCU board, version V1.0.

The hardware is composed of the following main blocks:

- **On-board Debugger** [IC2] the board features an on-board debugger implemented via an XMC4200 microcontroller. This auxiliary microcontroller features a debug probe firmware delivered by SEGGER – JLink. This debugger is used for flashing the target microcontroller and for establishing a serial communication via USB.
- **Target Microcontroller** [IC1]: the main microcontroller is an XMC1100, QFN24 package, 64kB of flash. This device handles the communication with the sensor and data forwarding to USB via the debugger.
- **Power Supply** [IC3]: the IFX54211MBV33 is being used as LDO for supplying the debugger microcontroller and the target microcontroller with 3.3V. The input voltage is the USB supply – 5V.
- **Power Supply Monitoring** [R12, R13, R17, PWR1]:
  - ADC input voltage divider [R12, R13]: for USB supply monitoring. Signal translated to 3.3V levels.
  - Power ON LED [PWR1] and series resistor [R17]: for indicating power supply voltage presence.
- **ADC input voltage dividers** [R11, R14, R15, R16]:
  - AOUT signal (5V) translated to 3.3V levels [R16, R11].
  - REF signal (5V) translated to 3.3V levels [R15, R14].
- **External Pull-Up resistors** [R7, R8]:
  - One (1k ohm) pull-up resistor for the DCDI communication [R8] and one (4k7 ohm) pull-up resistor for the OCD pin [R7].
- **Reference voltage multiplexer** [MUX]: the MAX4624EUT multiplexer is used for reference voltage control. Different configurations are needed based on the sensor's output mode [1]:
  - When MUX SEL signal is LOW, VREF is connected to NC (normally connected) side. In this case, VREF is being fed into the ADC of the XMC1100 via the resistive divider.
  - When MUX SEL signal is HIGH, VREF is connected to NO (normally open) side. In this case the reference voltage generated on the PCB is fed to the sensor for single ended modes.
- **Complementary MOSFET** [Q1] (BSL308C):
  - One PMOS used for translating OCD signals to LED.
  - One NMOS used for modifying the sensor's reference voltage in the reference voltage generation block.
- **Reference voltage generation block** [R5, R6, R10]:
  - When Q1 (NMOS side) is OFF, sensor's reference voltage is 50% of VDD (~2.5V).
  - When Q1 (NMOS side) is ON, sensor's reference voltage is 25% of VDD (~1.25V).
- **Connectors** [X2, X3, X4]:
  - In-plane edge connector [X2]: for connection to the TLE4973 sensor board.
  - Exposed side connectors [X3, X4]: for optional connection of sensor signals (e.g. from modules, probing etc.).

User Guide

TLE4973\_MS2GO kit Description

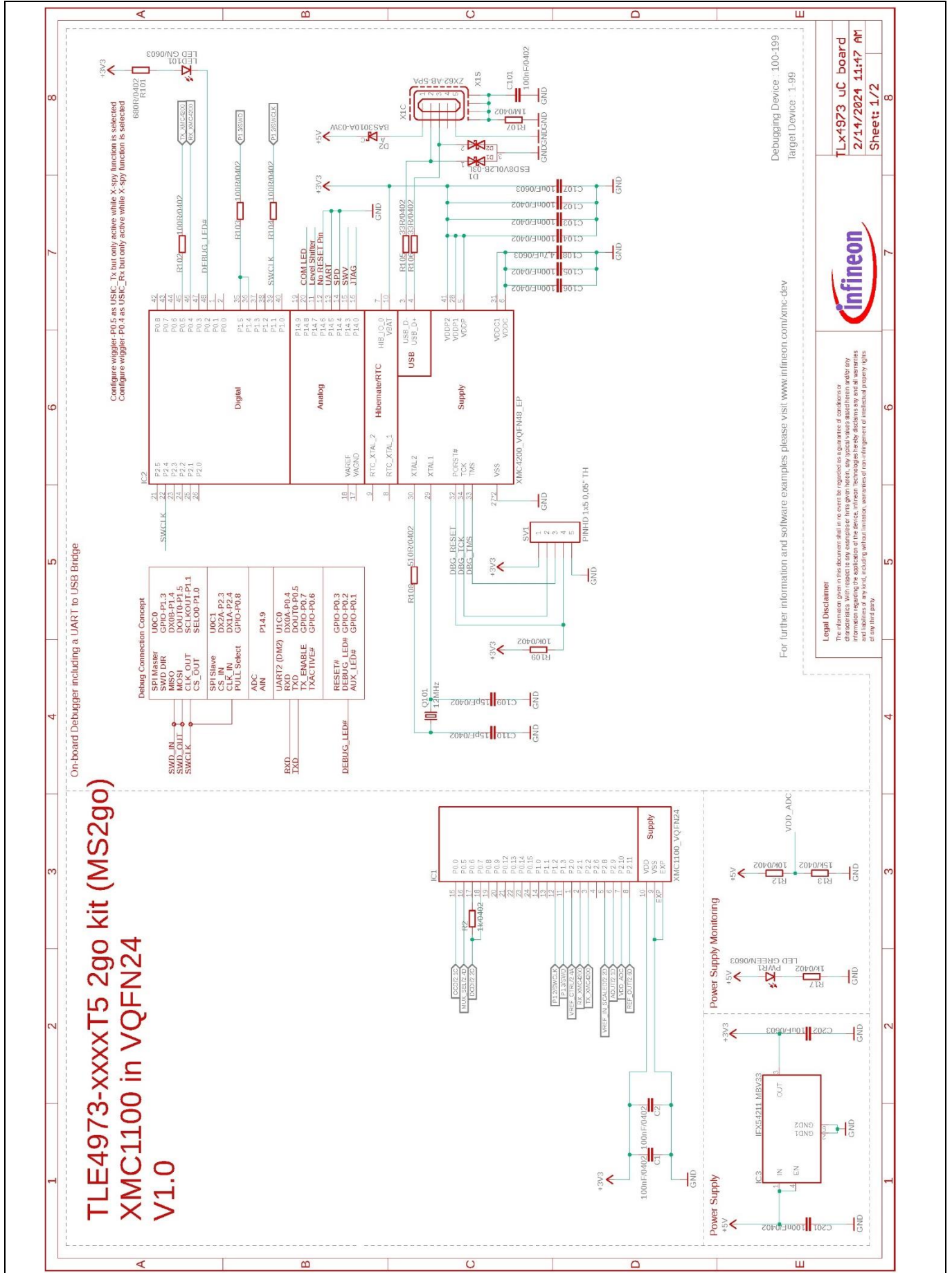

Figure 15 MCU Board Schematic - Sheet 1

User Guide

TLE4973\_MS2GO kit Description

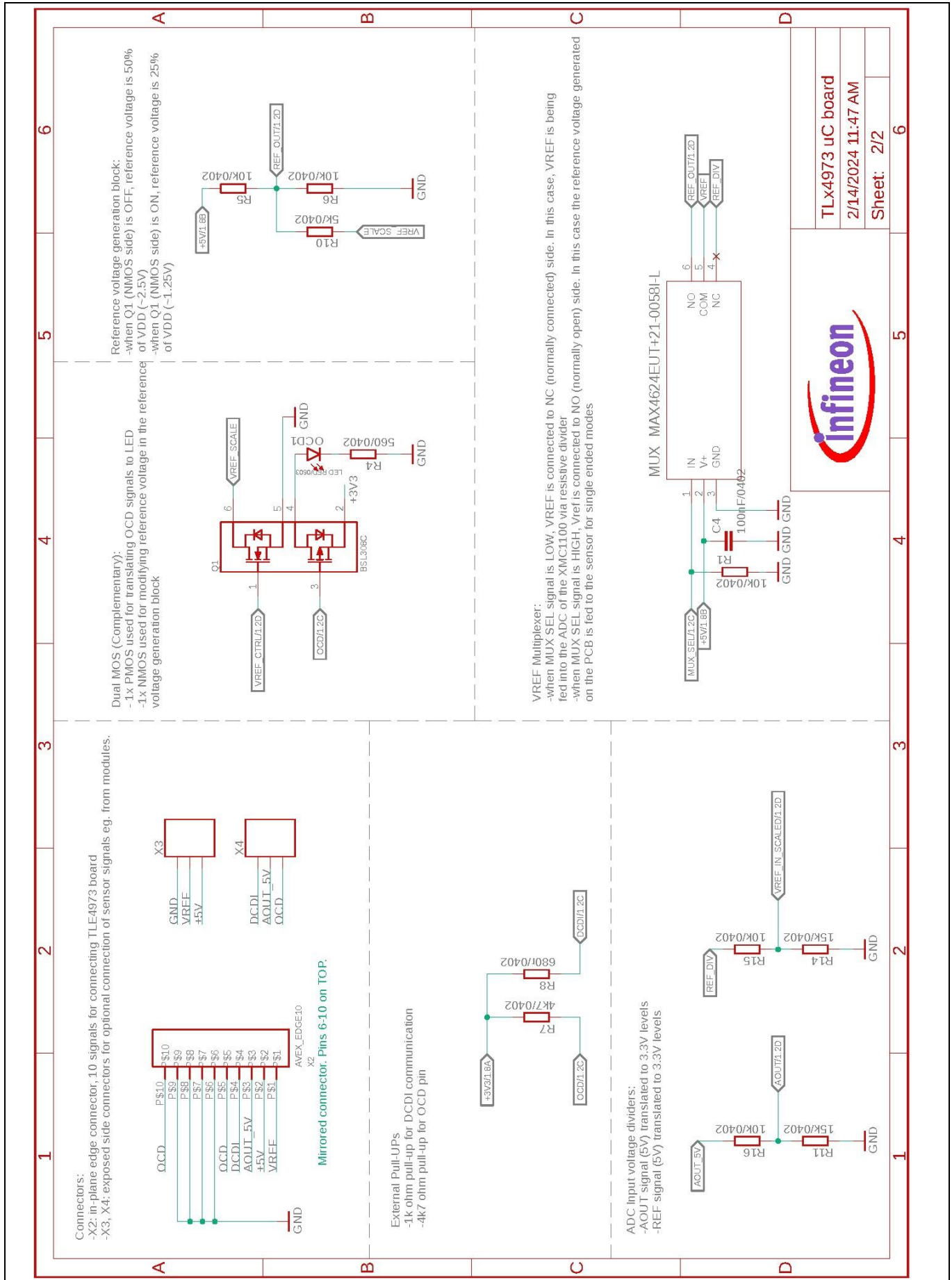

Figure 16 MCU Board Schematic -Sheet 2



## User Guide

### TLE4973\_MS2GO kit Description

#### 2.2.3 PCB Layout

The design described in sections 2.2.1 and 2.2.2 is physically implemented in PCB technology using a standard process with following characteristics:

- PCB material: FR4.
- Copper: 4 layers Top/Inner1/Inner2/Bottom, 35µm thickness each.
- 45-degree chamfer on connector side.

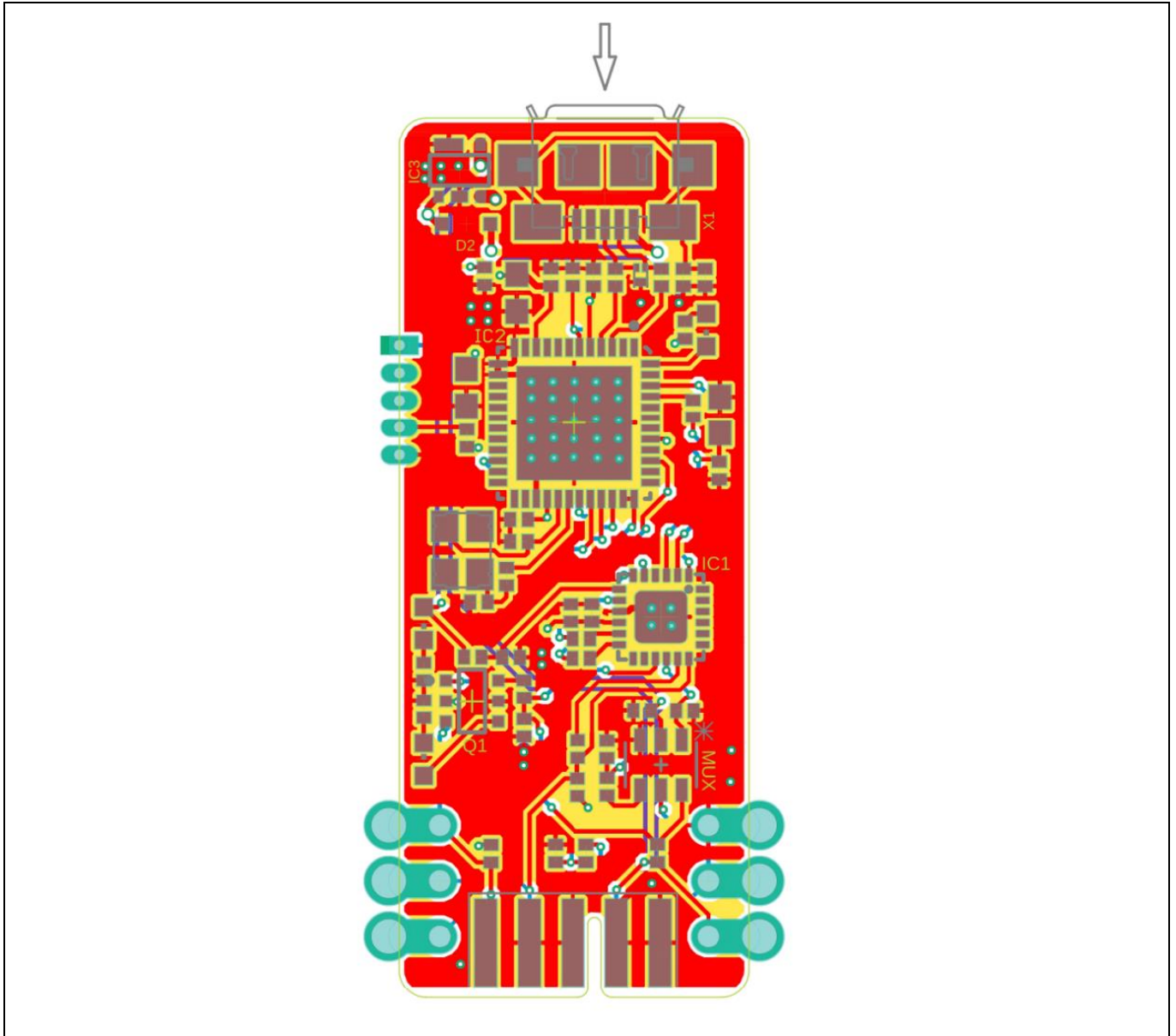

Figure 17 MCU Board PCB Layout

User Guide

TLE4973\_MS2GO kit Description

2.2.4 Bill of Materials

Table 3 TLE4973\_MS2GO kit MCU Board bill of materials

Designator	Description	Quantity	Assembled on PCB	Infineon Part
C1, C2, C4, C101, C102, C103, C104, C105, C106, C201	100nF 0402 10V 10%	10	YES	NO
C107, C202	10µF 0603 10V 10%	2	YES	NO
C108	4.7µF 0603 10V 10%	1	YES	NO
C109, C110	15pF 0402 10V 10%	2	YES	NO
D1	ESD8V0L2B-03L	1	YES	<b>YES</b>
D2	BAS3010A-03W	1	YES	<b>YES</b>
IC1	<b>XMC1100_VQFN24 (Target MCU)</b>	1	YES	<b>YES</b>
IC2	<b>XMC4200_VQFN48 (Debugger)</b>	1	YES	<b>YES</b>
IC3	IFX54211 MBV33	1	YES	<b>YES</b>
LED101	LED GN CHIPLD_0603	1	YES	NO
MUX	MAX4624EUT+21-0058I-L	1	YES	NO
OCD1	LED RED CHIPLD_0603	1	YES	NO
PWR1	LED GREEN CHIPLD_0603	1	YES	NO
Q1	BSL308C, SOP95P250X110-6N-1-V1	1	YES	<b>YES</b>
Q101	12MHz NX3225_2	1	YES	NO
R1, R109	10k 0402 10%	2	YES	NO
R2, R17	1k 0402 10%	2	YES	NO
R4	560R 0402 10%	1	YES	NO
R5, R6, R12, R15,R16	10k 0402 1%	5	YES	NO
R7	4k7 0402 10%	1	YES	NO
R8	680R 0402 10%	1	YES	NO
R10	5k 0402 1%	1	YES	NO
R11, R13, R14	15k 0402 1%	3	YES	NO
R101	680R 0402 10%	1	YES	NO
R102, R103, R104	100R 0402 10%	3	YES	NO
R105, R106	33R 0402 1%	2	YES	NO
R107	1M 0402 10%	1	YES	NO
R108	510R 0402 10%	1	YES	NO
SV1	PINHD 1x5 0	1	<b>NO</b>	NO
X1	ZX62-AB-5PA_MICRO-USB	1	YES	NO
X2	AVEX_EDGE10	1	<b>NO</b>	NO
X3	PINHD_1X3_S2GO	1	<b>NO</b>	NO
X4	PINHD_1X3_S2GO	1	<b>NO</b>	NO

## User Guide

### TLE4973\_MS2GO kit Description

### 2.3 In-Plane Edge Connector

The in-plane edge connector is used to establish the connection between the MCU board and the sensor board. This is a 10 way open ended card edge connector with asymmetric keying which prevents mating in an incorrect orientation.

The below figure shows the in-plane edge connector correct setup with the MCU and sensor board. Always connect the two PCBs with all components facing the same side as shown in **Figure 18**.

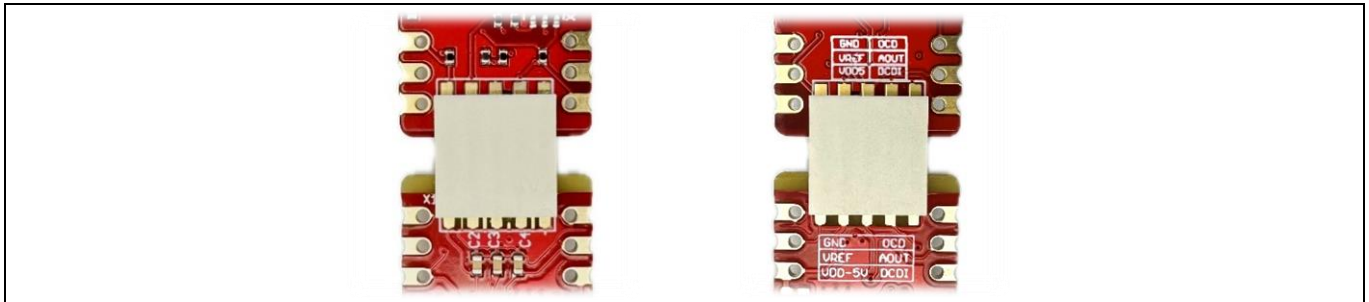

**Figure 18 In-Plane Edge Connector Top and Bottom Setup**

## 3 Current Sensor 2GO Evaluation Software

### 3.1 Safety precautions

Due to the design rules followed for high voltage application, the TLE4973\_MS2GO kit can directly connect to the output of any inverter stage like a half-bridge of MOS-FETs. All isolation is done in the TISON-8-5 package and no further efforts are necessary.

The USB-connector is on the same ground as the sensor, and for this reason it is safe to connect the TLE4973\_MS2GO kit directly to the output-stage as long as the applications parameters are in line with safety precautions limits.

When deciding to perform measurements outside of the safety precautions limits, consider adding additional safety measures (e.g. USB isolation, supply isolation, thermal dissipation etc.).

### 3.2 Overview

This chapter describes all features and their usage of the XENSIV™ Current Sensors MS2Go Evaluation App in correlation with the TLE4973\_MS2GO kit. Please make sure that the evaluation kit is attached to the PC via micro-USB cable before exploring next steps.

### 3.3 Startup Screen and Connecting to the Programmer

**Figure 19** depicts the default screen of the evaluation application after startup.

The graphical user interface software will monitor all USB ports and check if any connected device matches the signature of the evaluation kit. If a match is found, a new device will appear as depicted in **Figure 19**: “Port COMx”. By selecting the device, the Graphical User interface will connect and flash the correct firmware for the target microcontroller.

Note: If the target does not feature the latest firmware, the software will update it automatically.

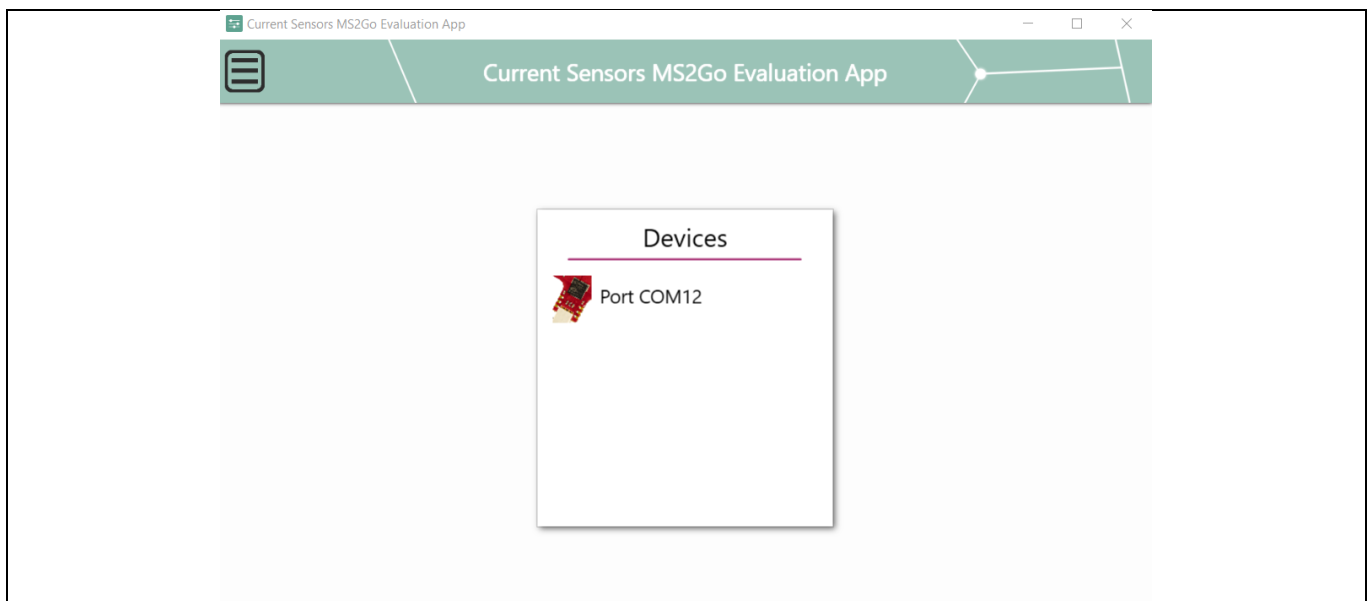
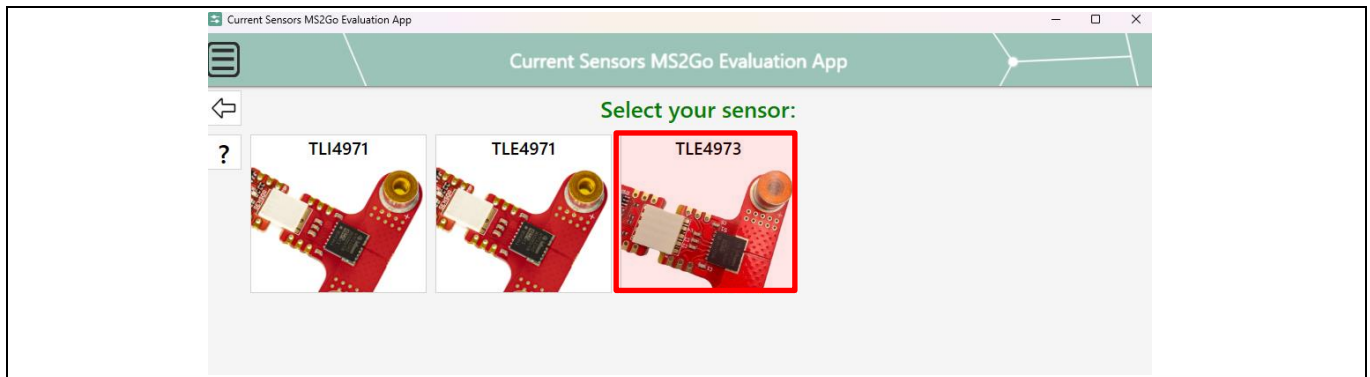

**Figure 19** Startup Screen

## User Guide

### Current Sensor 2GO Evaluation Software

The XENSIV™ Current Sensors MS2Go Evaluation App is a graphical user interface compatible with multiple board types including TLE4971\_MS2GO, TLI4971\_MS2GO, TLI4971\_S2GO and TLE4973\_MS2GO evaluation kits. In the next window, please make sure you select the correct hardware for this use-case: **TLE4973**.



**Figure 20 Hardware selection**

### 3.4 Main Window and Graphical Elements

Once a sensor is selected from the hardware selection screen, the graphical user interface changes as it is shown in **Figure 21**. The main functions are listed below and explained in detail in the following sections.

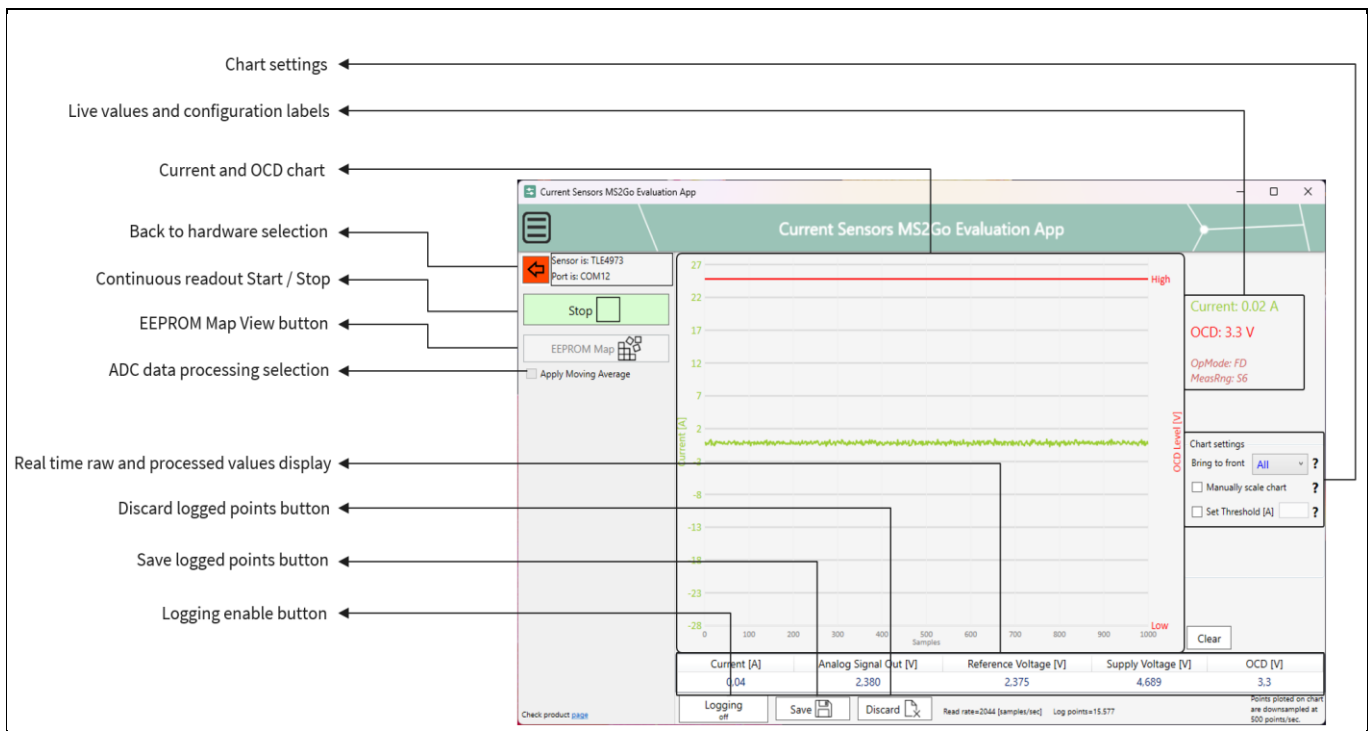

**Figure 21 Main Window Description**

#### 3.4.1 Sensor Readout and Data Logging

Data acquisition can be started by pressing the corresponding “Start” button. The GUI begins plotting the real-time current value (in ampere scale) and the OCD line status in the middle pane of the TLE4973\_MS2GO kit window. An example sensor readout for the TLE4973 is shown in **Figure 22**.

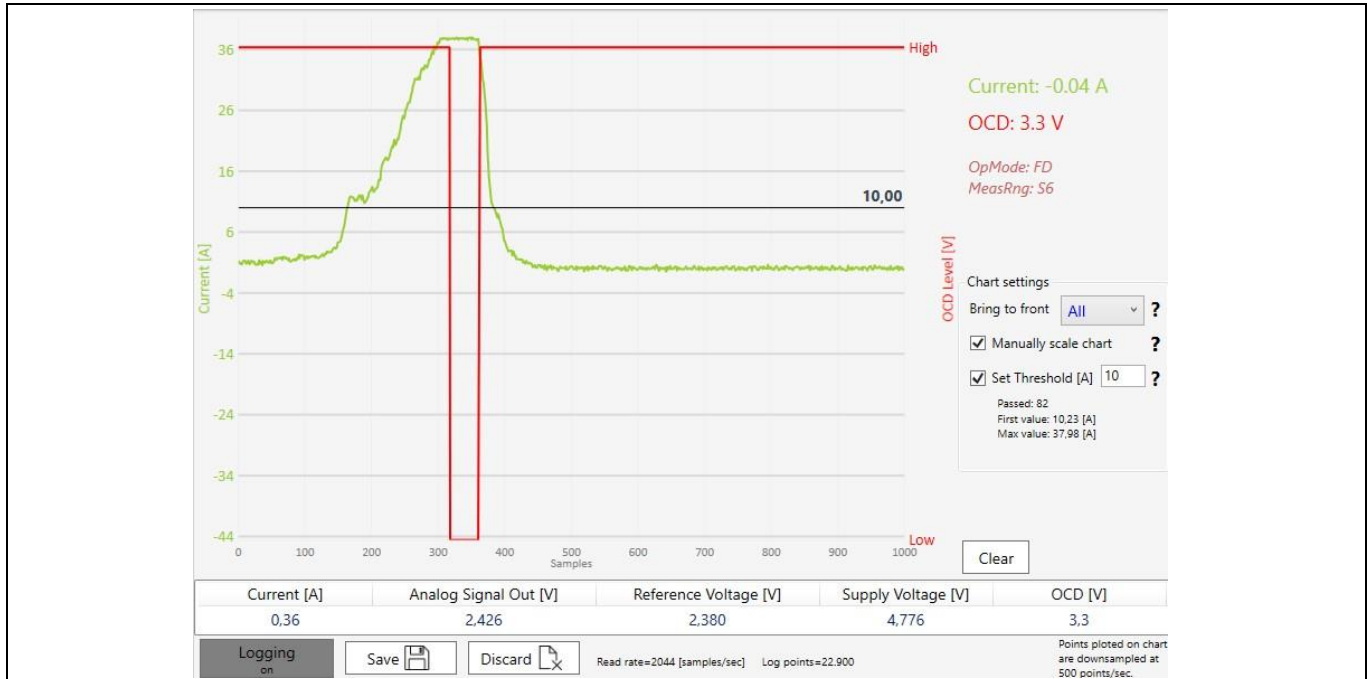

Figure 22 Data Logging and Readout Example - GUI

Current and OCD values together with the sensor’s configured Output Mode and Measurement Range are displayed in the labels positioned on the top right corner of the view.

The list view situated on the bottom part of the GUI is used for displaying real-time raw and processed values:

- Computed current in amperes with two decimal places.
- AOUT voltage in volts with three decimal places.
- VREF voltage in volts with three decimal places.
- Sensor supply voltage in volts with three decimal places.
- OCD logic level translated to volts.

Chart settings placed on the right side of the plot allow the user to configure two settings:

- Manually scale chart checkbox: this setting will allow user to adjust the scale of the graph by scrolling over it.
- Threshold checkbox: this setting will add an indication line on the plot to the value selected by user.

The user can decide if the acquired data needs to be logged and extracted in CSV format. By default, logging is disabled in order to minimize RAM usage. The user can click on the “Logging” button, and if the state is changed to “ON”, the software will save all acquired values in RAM. Please note that for protecting RAM usage, it is allowed to store maximum 100.000 points – if this limit is reached, a pop-up window will notify the user and data logging will be stopped.

After ending the measurement by clicking the “Stop” button, the user has the following options:

- Discarding acquired data, by pressing the “Discard” button.
- Saving acquired data to disk, in CSV format, by clicking “Save” button which will open the save file dialog.

The CSV format (Comma Separated Values) implemented in this tool uses as delimiter the semicolon sign “;”. If the default separator of the operating system differs, the user may use the “column split by delimiter” function of post-processing software (e.g. Microsoft Excel).

User Guide

Current Sensor 2GO Evaluation Software

The exported CSV file has the following structure:

- Header section: in this section, the software will log generic data as sensor name, timestamp, number of logged points, acquisition frequency, user comment.
- Data section: each logged line consists of a data bundle containing: index, computed current, analog output signal data, reference voltage, sensor supply and over current detection.

An example of the exported data is depicted in **Figure 23**.

Sample Index	Current [A]	Analog Signal Out [mV]	Analog Signal Out [LSB]	Reference Voltage [mV]	Reference Voltage [LSB]	Sensor Supply [V]	OCD[V]
0	10.46	3044,8	0x8DB	1735,3	0x1292	4777,4	3,3
1	10.25	3050,2	0x8DF	1764,8	0x1314	4784,1	3,3
2	10.32	3030	0x8D0	1738	0x1294	4778,8	3,3
3	10.38	3031,4	0x8D1	1731,3	0x1289	4780,1	3,3
4	10.26	3036,8	0x8D5	1752,7	0x1305	4773,4	3,3
5	10.65	3051,5	0x8E0	1720,5	0x1281	4769,4	3,3
6	10.55	3058,2	0x8E5	1736,6	0x1293	4781,4	3,3
7	10.8	3112	0x90D	1759,5	0x1310	4778,8	3,3
8	10.42	3056,9	0x8E4	1751,4	0x1304	4782,8	3,3
9	10.72	3063,6	0x8E9	1719,2	0x1280	4784,1	3,3
10	10.81	3054,2	0x8E2	1703,1	0x1268	4770,7	3,3
11	10.58	3046,2	0x8D8	1719,2	0x1280	4785,5	3,3
12	10.78	3074,4	0x8F1	1723,2	0x1283	4782,8	3,3
13	10.79	3071,7	0x8EF	1720,5	0x1281	4778,8	3,3
14	11.02	3070,3	0x8EE	1691	0x1259	4776,1	3,3
15	11.29	3105,3	0x908	1691	0x1259	4781,4	3,3
16	11.26	3110,6	0x90C	1699	0x1265	4784,1	3,3
17	11.38	3121,4	0x914	1695	0x1262	4781,4	3,3
18	11.45	3113,3	0x90E	1681,6	0x1252	4770,7	3,3
19	11.54	3146,9	0x927	1700,4	0x1266	4781,4	3,3
20	11.54	3118,7	0x912	1674,8	0x1247	4772	3,3
21	11.28	3086,4	0x8FA	1673,5	0x1246	4780,1	3,3
22	11.42	3109,3	0x90B	1677,5	0x1249	4785,5	3,3
23	11.68	3138,8	0x921	1676,2	0x1248	4777,4	3,3
24	11.76	3145,5	0x926	1670,8	0x1244	4785,5	3,3
25	11.17	3091,8	0x8FE	1692,3	0x1260	4780,1	3,3
26	11.86	3140,2	0x922	1657,4	0x1234	4769,4	3,3
27	11.74	3129,4	0x91A	1661,4	0x1237	4770,7	3,3

Figure 23 Data Logging and Example – Exporting in CSV format

### 3.4.2 ADC data processing

The default setting for the firmware is to send raw ADC samples for interpretation. The user has the option to change data processing in firmware and to apply a moving average over a fixed 16 ADC readings.

Applying the moving average is a way of smoothing ADC data. A fixed-size window is defined, and as new data comes in, the oldest data is removed from the window, and a new average is calculated. This is achieved with a circular buffer to keep the computational overhead low.

The user can change this setting by toggling the checkbox show in **Figure 24**. This setting is available only when the readout is stopped.

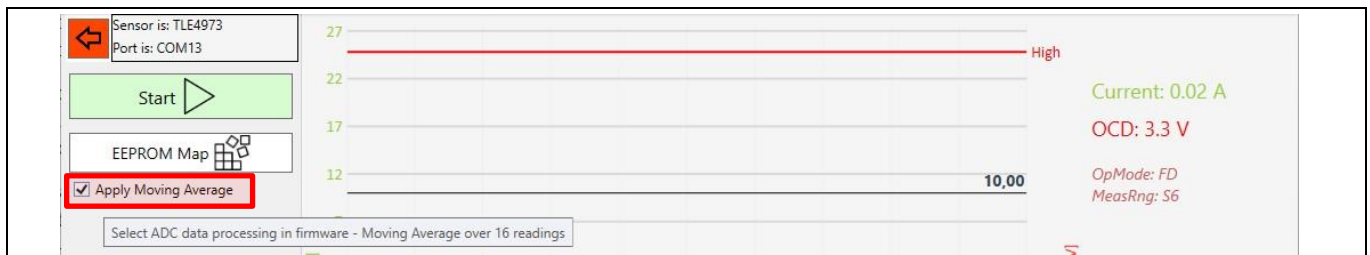

Figure 24 ADC data processing selection

### 3.4.3 EEPROM Map and configuration

This section gives an overview of the programmable content of the current sensor and its software implementation.

The sensor's nonvolatile memory (EEPROM) is organized in 16 bits registers which can be addressed individually. The storage space is separated into two areas, user area with read/write access and the read only area [1].

Address lines from 40hex to 42hex contain the configuration parameters and are accessible for the user to be set according to individual application requirements. The calibration coefficients stored in the addresses from 43hex to 4Ahex cannot be modified by the user in case of internal current rail devices (PG-TISON-8 package), but only in case of external current rail devices (PG-VSON-6 and PGTDSO-16 packages). Addresses from 4Bhex to 51hex are not to be changed by the user. The last two lines, from address 52hex to 53hex, contain the chip ID [1].

When the user selects the “EEPROM Map” menu item, the window shown in **Figure 25** will open. Here, the user will see the content of the EEPROM of the current sensor in the TLE4973\_MS2GO kit. Through the programming feature of TLE4973, all the content is allowed to be modified and reprogrammed again.

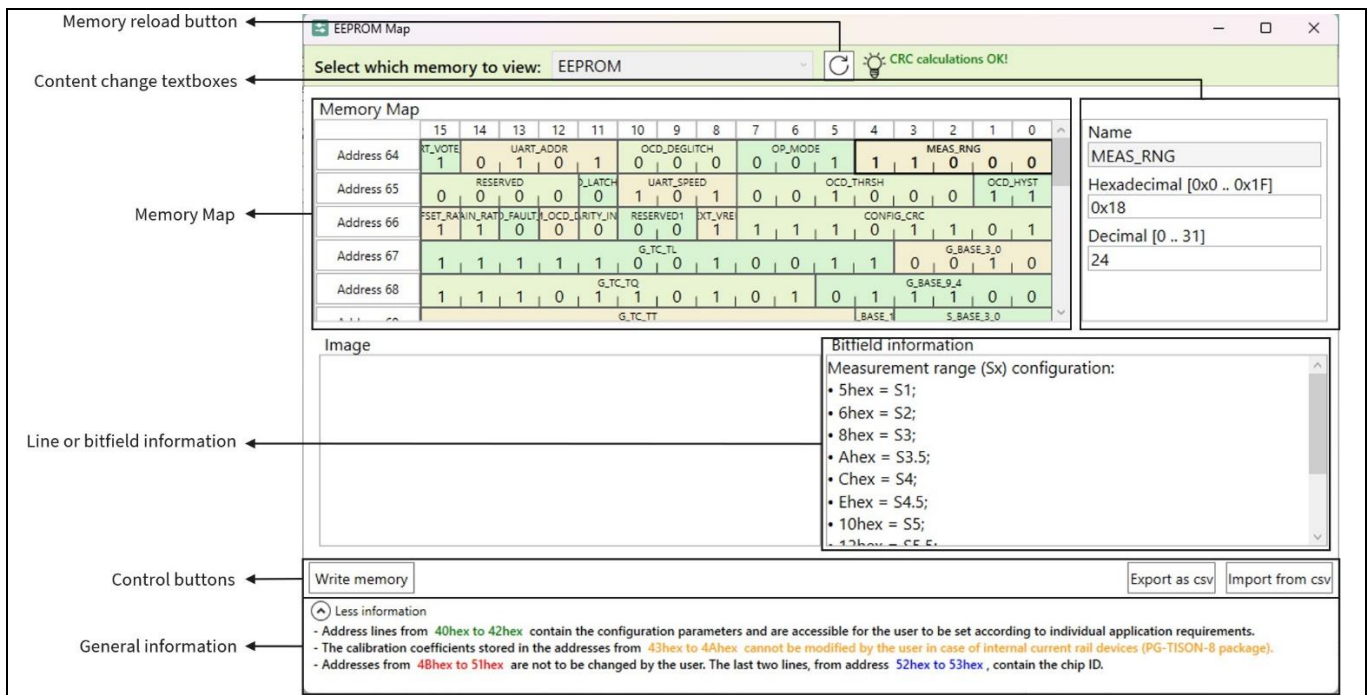

Figure 25 Non-volatile Memory Map Window

The Memory Map view implements the next functionalities:

- Modification of a single bitfield or memory line: can be easily performed by clicking into the field section and altering the content in the configuration textboxes (both hexadecimal and decimal values are supported). Changes do not take place until the “Write memory” button is pressed.
- Reload button for memory refresh.
- Bitfield or memory line information is displayed in the bottom right corner of the view.
- General EEPROM information displayed in the bottom of the view.
- CRC recalculations is performed in the background whenever the EEPROM is modified.
- Memory configuration export: The user has the option to export the current memory configuration (as seen in the map view) as a .csv file by pressing the “Export as csv” button.



User Guide

Current Sensor 2GO Evaluation Software

- Memory configuration import: The user has the option to import a .csv file with the same format as the memory and bring it in the Memory Map view with the option of altering and writing it. This function is useful for writing full configurations of the sensor. An example of a memory configuration file is depicted in **Figure 26**.
- Automatic detection and recalculation of wrong CRC in imported file.
- Integrity checks are performed before writing the EEPROM with new values as to prevent the user from entering invalid values for the next bitfields: Output mode, Measurement range and DCDI data rate.

	A	B	C
1	Date	27.05.2024	
2	TLE4973_MS2go EEPROM Map		
3			
4	Comment: TLE4973 EEPROM		
5			
6			
7	Address	Name	Value
8	64	EEPROM Line 64/0x40: UART and OCD settings. Output Operation Modes and measurement Range.	43064
9	65	EEPROM Line 65/0x41: UART and OCD settings. OCD hysteresis and threshold.	1315
10	66	EEPROM Line 66/0x42: Offset and gain ratiometricity, OCD fault disable, OCD disable, Polarity inversion. External VREF setting and CRC.	49645
11	67	EEPROM Line 67/0x43: Offset, gain and stress temperature calibration coefficients.	63794
12	68	EEPROM Line 68/0x44: Offset, gain and stress temperature calibration coefficients.	60764
13	69	EEPROM Line 69/0x45: Offset, gain and stress temperature calibration coefficients.	3744
14	70	EEPROM Line 70/0x46: Offset, gain and stress temperature calibration coefficients.	2132
15	71	EEPROM Line 71/0x47: Offset, gain and stress temperature calibration coefficients.	3173
16	72	EEPROM Line 72/0x48: Offset, gain and stress temperature calibration coefficients.	0
17	73	EEPROM Line 73/0x49: Offset, gain and stress temperature calibration coefficients.	8
18	74	EEPROM Line 74/0x4A: Offset, gain and stress temperature calibration coefficients.	480
19	75	EEPROM Line 75/0x4B: RESERVED 1	63737
20	76	EEPROM Line 76/0x4C: RESERVED 2	60427
21	77	EEPROM Line 77/0x4D: RESERVED 3	32512
22	78	EEPROM Line 78/0x4E: RESERVED 4	36046
23	79	EEPROM Line 79/0x4F: RESERVED 5	19520
24	80	EEPROM Line 80/0x50: RESERVED 6	40965
25	81	EEPROM Line 81/0x51: RESERVED 7	55665
26	82	EEPROM Line 82/0x52: Chip ID1	21765
27	83	EEPROM Line 83/0x53: Chip ID2	2905

Figure 26 Memory configuration file example

The memory configuration of the sensor is automatically parsed at the start of the software and after every memory access. This function is used for automatic control and data interpretation:

- The voltage reference configuration is automatically controlled according to the Output mode and external VREF configurations programmed in the EEPROM.
- The current computation is done according to the Output mode and Measurement range.
- Ratiometric calculations with regards to Sensitivity  $(S(V_{DD}) = S(5V) \times \frac{V_{DD}}{5V})$  are applied if both configuration bits are set in the EEPROM (offset\_ratio and gain\_ratio), otherwise default selected sensitivity is used [2].

## **4 Appendix I – Hardware Revision History**

The chapters **2.1 and 2.2** of this document describe the current state of the hardware: revision V1.0. This APENDIX will highlight the main hardware modifications implemented from revision 1.0 (first release) to the current revision.

## 5 Glossary

Abbreviation	Description
MS2Go	Magnetic Sensor to Go
PCB	Printed Circuit Board
GUI	Graphical User Interface
EEPROM	Electrically Erasable Programmable Read-Only Memory
OCD	Over Current Detection
USB	Universal Serial Bus
DUT	Device Under Test
HV	High Voltage
LED	Light Emitting Diode
MCU	Micro-Controller Unit
DCDI	Digital Control Diagnostic Interface
AN	Application Note
SW	Software

## 6 References

- [1] Infineon-TLE4973\_magnetic\_current\_sensor-UserManual-vxx\_xx-EN
- [2] Infineon-TLE4973-RE35x5-S0010-DS-vxx\_xx-EN; Infineon-TLE4973-RxxxT5-S0010-DS-vxx\_xxEN; Infineon-TLE4973-xE35x5-S0001-DS-vxx\_xx-EN; Infineon-TLE4973-xxxxT5-S0001-DS-vxx\_xx-EN

**Revision history**

<b>Document version</b>	<b>Date of release</b>	<b>Description of changes</b>
V 1.0	2024-05-29	Initial version

#### Trademarks

All referenced product or service names and trademarks are the property of their respective owners.

**Edition 2024-05-16**

**Published by**

**Infineon Technologies AG**

**81726 Munich, Germany**

**© 2024 Infineon Technologies AG.**

**All Rights Reserved.**

**Do you have a question about this document?**

**Email:** [erratum@infineon.com](mailto:erratum@infineon.com)

**Document reference**

**AppNote TLE4973 Current sensor 2GO kit User Guide**

#### IMPORTANT NOTICE

The information contained in this application note is given as a hint for the implementation of the product only and shall in no event be regarded as a description or warranty of a certain functionality, condition or quality of the product. Before implementation of the product, the recipient of this application note must verify any function and other technical information given herein in the real application. Infineon Technologies hereby disclaims any and all warranties and liabilities of any kind (including without limitation warranties of non-infringement of intellectual property rights of any third party) with respect to any and all information given in this application note.

The data contained in this document is exclusively intended for technically trained staff. It is the responsibility of customer's technical departments to evaluate the suitability of the product for the intended application and the completeness of the product information given in this document with respect to such application.

For further information on the product, technology, delivery terms and conditions and prices please contact your nearest Infineon Technologies office ([www.infineon.com](http://www.infineon.com)).

#### WARNINGS

Due to technical requirements products may contain dangerous substances. For information on the types in question please contact your nearest Infineon Technologies office.

Except as otherwise explicitly approved by Infineon Technologies in a written document signed by authorized representatives of Infineon Technologies, Infineon Technologies' products may not be used in any applications where a failure of the product or any consequences of the use thereof can reasonably be expected to result in personal injury.

# Mouser Electronics

Authorized Distributor

Click to View Pricing, Inventory, Delivery & Lifecycle Information:

[Infineon:](#)

[TLE4973MS2GOTOBO1](#)