

TLE4972 Lateral insertion 45° S-bend on Schweizer Inlay PCB

User guide

About this document

This document describes the evaluation board of TLE4972, Infineon's magnetic current sensor for automotive applications with external current rail.

Scope and purpose

The evaluation board is meant to be used by the customer solely for the purpose of evaluation and testing. It is not a commercial product and shall not be used for series production. This board is thus not intend to meet any industrial specifications and shall be operated at room temperature.

Due to its purpose, the evaluation board is not subject to the same procedures as regular products regarding Returned Material Analysis (RMA), Process Change Notification (PCN) and Product Withdraw (PWD).

Intended audience

This document is written for customers who intend to use TLE4972 in current sensing applications.

Evaluation Board

This board will be used during design in, for evaluation and measurement of characteristics, and proof of datasheet specifications.

Note: PCB and auxiliary circuits are NOT optimized for final customer design. Boards do not necessarily meet safety, EMI, quality standards (for example UL, CE) requirements.

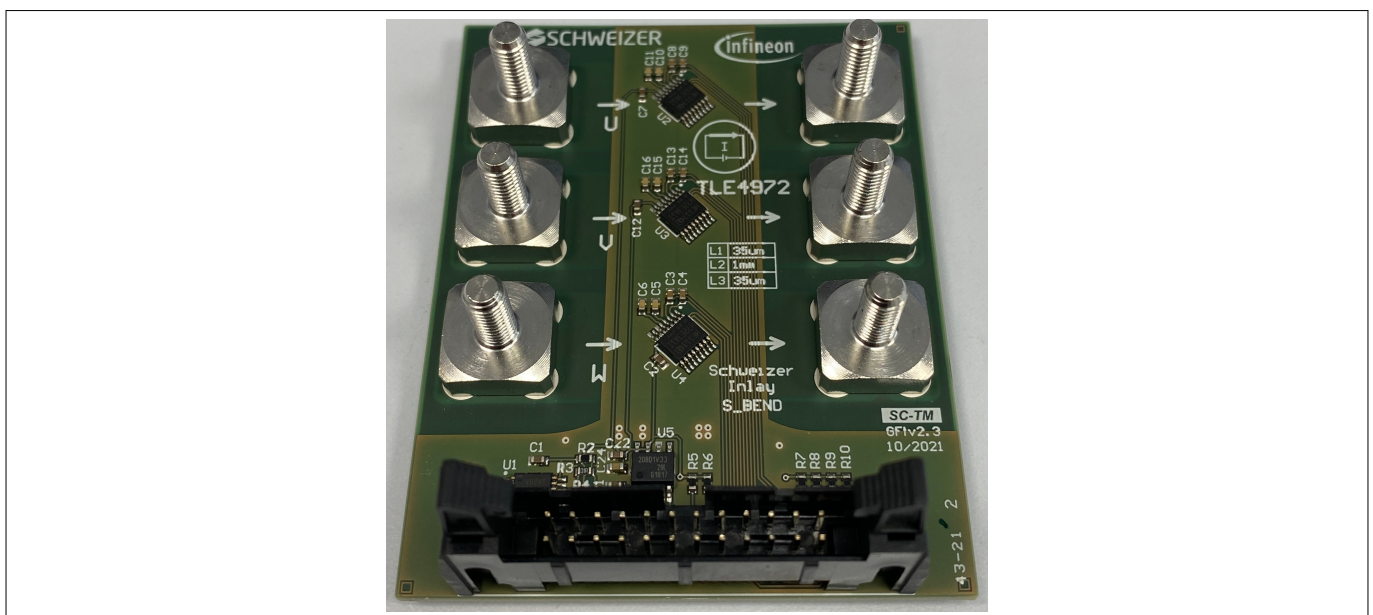

Figure 1 TLE4972 EVAL INLAY

Table of contents

	Table of contents	2
1	Important notice	3
2	Safety precautions	4
3	The board at a glance	5
3.1	Delivery content	5
3.2	Block diagram	5
3.3	Main features	5
3.4	Board parameters and technical data	5
4	System and functional description	7
4.1	Commissioning	7
4.2	Description of the functional blocks	7
4.3	Sensing Structure Layout & Guidelines	7
5	System design	8
5.1	Schematics	8
5.2	Layout	9
5.3	Bill of material	11
5.4	Connector details	11
6	System performance	13
6.1	Test points	13
6.2	Test results	13
6.2.1	Measurement results	13
6.2.1.1	Sensitivity drift and offset drift over temperature	13
6.2.1.2	Frequency response	14
6.2.1.3	Crosstalk	15
6.2.1.4	Thermal capability	16
6.2.2	Simulation results	16
6.2.2.1	Conductor and insertion resistance	17
6.2.2.2	Transfer factor error due to sensor displacement	18
7	References and appendices	20
7.1	Abbreviations and definitions	20
7.2	References	20
8	Revision history	21
	Disclaimer	22

1 Important notice

1 Important notice

“Evaluation Boards and Reference Boards” shall mean products embedded on a printed circuit board (PCB) for demonstration and/or evaluation purposes, which include, without limitation, demonstration, reference and evaluation boards, kits and design (collectively referred to as “Reference Board”).

Environmental conditions have been considered in the design of the Evaluation Boards and Reference Boards provided by Infineon Technologies. The design of the Evaluation Boards and Reference Boards has been tested by Infineon Technologies only as described in this document. The design is not qualified in terms of safety requirements, manufacturing and operation over the entire operating temperature range or lifetime.

The Evaluation Boards and Reference Boards provided by Infineon Technologies are subject to functional testing only under typical load conditions. Evaluation Boards and Reference Boards are not subject to the same procedures as regular products regarding returned material analysis (RMA), process change notification (PCN) and product discontinuation (PD).

Evaluation Boards and Reference Boards are not commercialized products, and are solely intended for evaluation and testing purposes. In particular, they shall not be used for reliability testing or production. The Evaluation Boards and Reference Boards may therefore not comply with CE or similar standards (including but not limited to the EMC Directive 2004/EC/108 and the EMC Act) and may not fulfill other requirements of the country in which they are operated by the customer. The customer shall ensure that all Evaluation Boards and Reference Boards will be handled in a way which is compliant with the relevant requirements and standards of the country in which they are operated.

The Evaluation Boards and Reference Boards as well as the information provided in this document are addressed only to qualified and skilled technical staff, for laboratory usage, and shall be used and managed according to the terms and conditions set forth in this document and in other related documentation supplied with the respective Evaluation Board or Reference Board.

It is the responsibility of the customer’s technical departments to evaluate the suitability of the Evaluation Boards and Reference Boards for the intended application, and to evaluate the completeness and correctness of the information provided in this document with respect to such application.

The customer is obliged to ensure that the use of the Evaluation Boards and Reference Boards does not cause any harm to persons or third party property. The Evaluation Boards and Reference Boards and any information in this document is provided "as is" and Infineon Technologies disclaims any warranties, express or implied, including but not limited to warranties of non-infringement of third party rights and implied warranties of fitness for any purpose, or for merchantability.

Infineon Technologies shall not be responsible for any damages resulting from the use of the Evaluation Boards and Reference Boards and/or from any information provided in this document. The customer is obliged to defend, indemnify and hold Infineon Technologies harmless from and against any claims or damages arising out of or resulting from any use thereof.

Infineon Technologies reserves the right to modify this document and/or any information provided herein at any time without further notice.

2 Safety precautions

2 Safety precautions

Note: Please note the following warnings regarding the hazards associated with development systems.



Figure 2 Safety Precautions

- **Warning:** Remove or disconnect power from the drive before you disconnect or reconnect wires, or perform maintenance work. Failure to do so may result in personal injury or death.
- **Warning:** Do not keep the programmer connected to the laptop while the board is in use in an inverter. The laptop may be damaged during the operation of the system.
- **Warning:** The evaluation board is intended to be used only in low voltage systems (≤ 50 V).
- **Caution:** The board and device surfaces of the evaluation board may become hot during testing. Hence, necessary precautions are required while handling the board. Failure to comply may cause injury. Please refer to [Chapter 6.2.1.4](#) for an indication of the heating due to the current flow.
- **Caution:** Only personnel familiar with the drive, power electronics and associated machinery should plan, install, commission and subsequently service the system. Failure to comply may result in personal injury and/or equipment damage.
- **Caution:** The evaluation board contains parts and assemblies sensitive to electrostatic discharge (ESD). Electrostatic control precautions are required when installing, testing, servicing or repairing the assembly. Component damage may result if ESD control procedures are not followed. If you are not familiar with electrostatic control procedures, refer to the applicable ESD protection handbooks and guidelines.
- **Caution:** A drive that is incorrectly applied or installed can lead to component damage or reduction in product lifetime. Wiring or application errors such as undersizing the motor, supplying an incorrect or inadequate AC supply, or excessive ambient temperatures may result in system malfunction.
- **Caution:** The evaluation board is shipped with packing materials that need to be removed prior to installation. Failure to remove all packing materials that are unnecessary for system installation may result in overheating or abnormal operating conditions.

3 The board at a glance

3 The board at a glance

TLE4972 evaluation board is developed to familiarize the users with TLE4972 current sensor for design in support and evaluation purposes. The complete evaluation kit consists of this board and the programmer board, which is explained in [1]. The programmer board supplies the sensors on the evaluation board and allows a fast and easy interfacing to each sensor. If the programmer board is not used, power supply has to be provided externally by the user.

3.1 Delivery content

The delivery content consist in TLE4972 evaluation board.

3.2 Block diagram

The evaluation board includes three TLE4972 coreless magnetic current sensors for testing in three-phase systems. The evaluation board has been designed to operate safely in low voltage systems (≤ 50 V). It is recommended to disconnect the USB cable between the programmer and the laptop while the system is in operation, in order to avoid damages to the laptop.

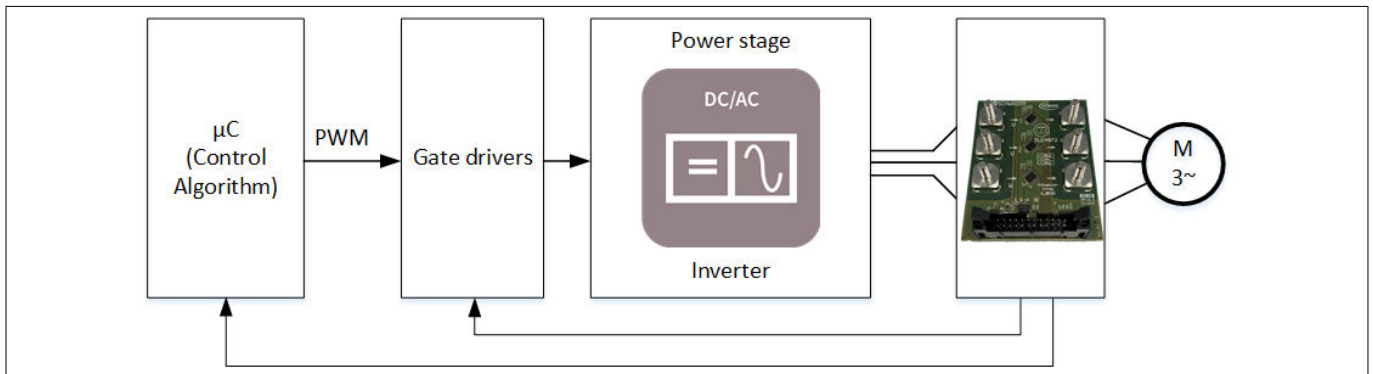

Figure 3 Block diagram of the evaluation board in use in a three-phase system

3.3 Main features

- Three TLE4972 sensors, for testing in three-phase systems;
- On board EEPROM to store board settings;
- Compatible with Infineon Current Sensor Programmer [1]

3.4 Board parameters and technical data

Table 1 Evaluation Board Overview

Product	TLE4972-AE35D5
Package	PG-TDSO-16
Evaluation board name	TLE4972 EVAL INLAY
Evaluation board order number	SP005632138
Insertion method name	45° s-bend on Schweizer Inlay PCB
Full scale (FS)	± 422.21 A
Typical current rail transfer factor	45.80 μ T/A
Typical sensor sensitivity	62 mV/mT (S3)
Typical evaluation board sensitivity	2.84 mV/A

(table continues...)

3 The board at a glance

Table 1 (continued) **Evaluation Board Overview**

Product	TLE4972-AE35D5
Output mode	Semi-differential
OCD1 threshold	598.65 A (139% of FS)
OCD2 threshold	347.44 A (82% of FS)
Typical insertion resistance	17 $\mu\Omega$
Current rail width	14 mm
Current rail thickness	1 mm

4 System and functional description

4 System and functional description

4.1 Commissioning

If the evaluation board is used in combination with the Infineon programmer board [1], it is sufficient to connect the two boards and follow the instructions on the GUI [1].

If instead the evaluation board is used as stand-alone, then the user has to supply the board with 5 V using pin 16 (positive terminal of the supply) and pin 20 or 22 (ground terminal of the supply) of the evaluation board connector. In order to enable the onboard LDO, pin 14 must be connected to 5 V as well. Please refer to [Chapter 5.4](#) for the complete pinout of the evaluation board connector.

4.2 Description of the functional blocks

The board consists of three TLE4972 current sensors to accurately sense AC and DC currents, a EEPROM to store the board settings, a LDO (Low Drop Out) regulator to stabilize the supply voltage of the sensors and a connector to connect to the Infineon programmer board [1]. For additional information about TLE4972 please refer to the user manual [2] and datasheet [3]. Guidelines about sensing structure design are given in the dedicated application note [4].

4.3 Sensing Structure Layout & Guidelines

The three sensors are mounted on a PCB and placed on top of the current rail inside the PCB. The sensors are twisted 45° in order to reduce the crosstalk between the three phases, without compromising the frequency response of the sensor and insertion resistance of the conductor. The current rail has a 0.5 mm s-shaped slit. Please refer to the sensing structure design application note [4] for further guidelines.

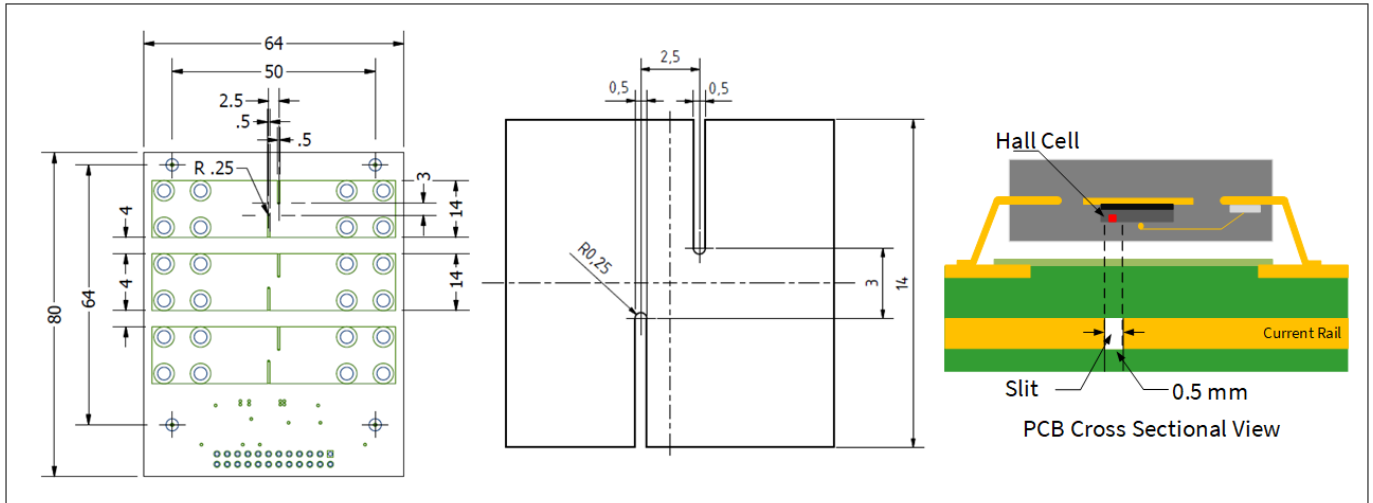

Figure 4 Sensing structure overview

5 System design

5.2 Layout

TLE4972 evaluation board consists of two 32 μm outer metallization layers and one 1 mm inner metallization layer. The inner layer is intended to carry the high current that is sensed by the sensors. Details are shown in the figure below.

#	Name	Material	Type	Thickness
	Top Overlay		Overlay	
	Top Solder	Solder Resist	Solder Mask	0.03mm
	galv. Cu top		Surface Finish	0.043mm
1	L1_Top	copper	Signal	0.032mm
	Prepreg1	FR4	Prepreg	0.05mm
	Prepreg2	FR4	Prepreg	0.05mm
2	Inlay	copper	Signal	1mm
	Prepreg3	FR4	Prepreg	0.05mm
	Prepreg4	FR4	Prepreg	0.05mm
3	L3_Bottom	copper	Signal	0.032mm
	galv. Cu bottom		Surface Finish	0.043mm
	Bottom Solder	Solder Resist	Solder Mask	0.03mm
	Bottom Overlay		Overlay	

Figure 6 Evaluation board layer stack up

The figure below shows the top and bottom layer of the evaluation board. Please contact your local Infineon sales office to receive the Gerber files.

5 System design

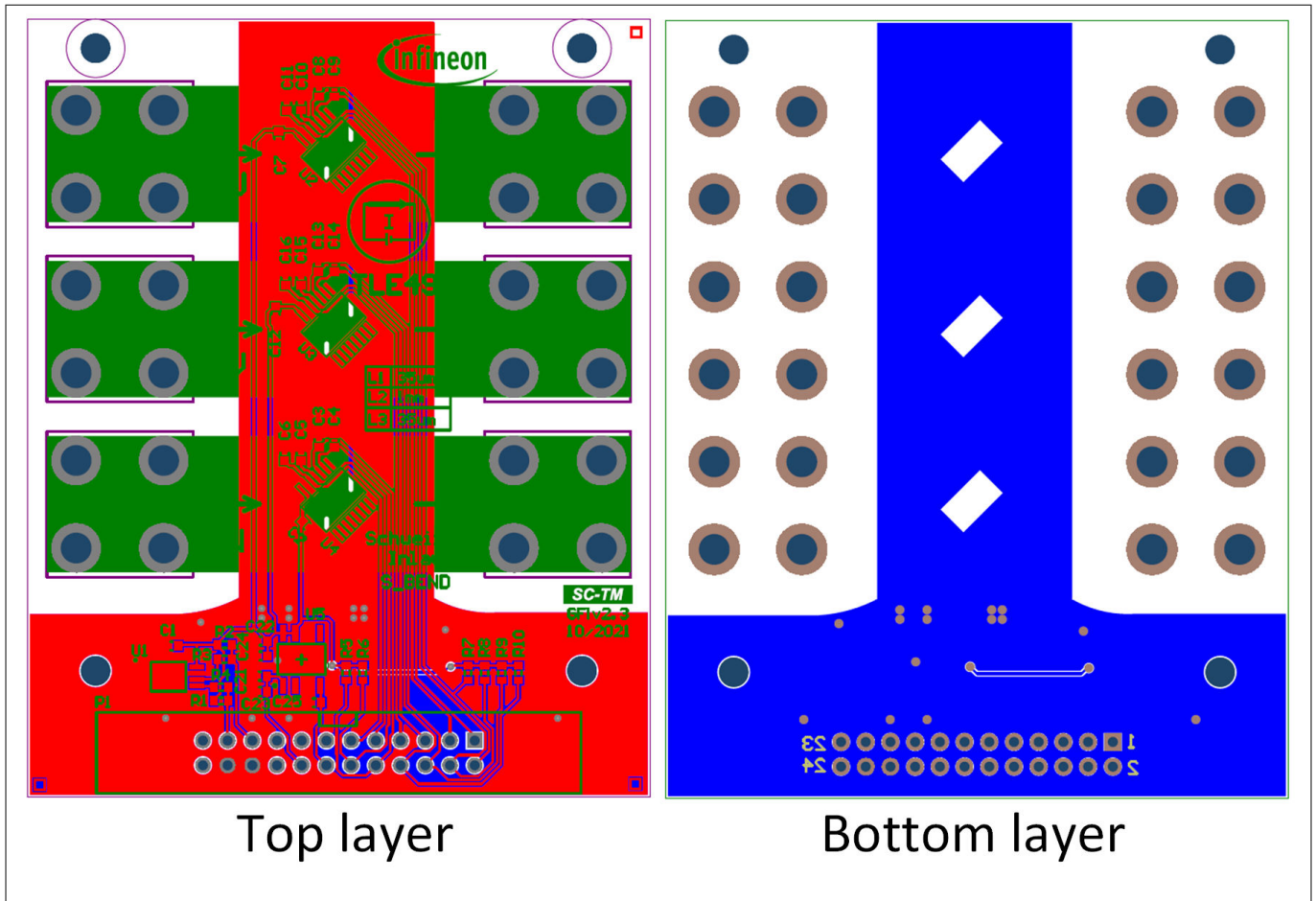

Figure 7 Evaluation board PCB layout (top and bottom layer)

AOUT and VREF tracks of each sensor are traced in parallel on the PCB in order to minimize the common mode noise on the output signal. Additionally, ground planes are used to protect the signal tracks and reduce the parasitic inductive couplings. The ground and power planes are cut below the TLE4972 including input and output pins to avoid the error induced due to the eddy currents. For the same reason, no heat sink or other conductor material shall be placed on the same position of the sensor.

5 System design

5.3 Bill of material

Table 2 Bill of Material

Quantity	Designator	Value	Footprint	Description
1	U5	-	SOIC-8	TLS208D1EJV33 (LDO)
3	U2, U3, U4	-	PG-TDSO-16	TLE4972 (current sensor)
1	U1	-	TSSOP8_W	M24C02-WDW6TP (EEPROM)
2	R3, R4	100 Ω ±1%	R0603	Resistors for EEPROM
8	R1, R2, R5, R6, R7, R8, R9, R10	1 kΩ ±1%	R0603	Pull-up resistors
1	P1	-	HDR2X12-Würth WR-BHD	Header, 24-Pin (2x12)
6	C5, C6, C10, C11, C15, C16	6.8 nF, 25V	C0603	AOUT and VREF capacitors
6	C3, C4, C8, C9, C13, C14	1 nF, 25V	C0603	OCD1/OCD2 capacitors
7	C1, C2, C7, C12, C21, C22, C25	220 nF, 25V	C0603	Bypass capacitors
2	C23, C24	22 μF, 10V	C0603	Bypass capacitors

5.4 Connector details

The evaluation board connector establishes the connection between the evaluation board and the programmer board. Please refer to the programmer user guide [1] for details about the programmer.

Table 3 Evaluation board connector pinout

Pin Number	Pin name	Pin function
1	AOUT1	Analog output voltage of sensor 1
2	OCD1_1	Over Current Detection channel 1 of sensor 1 (open drain)
3	VREF1	Reference voltage of sensor 1
4	OCD2_1	Over Current Detection channel 2 of sensor 1 (open drain)
5	AOUT2	Analog output voltage of sensor 2
6	OCD1_2	Over Current Detection channel 1 of sensor 2 (open drain)
7	VREF2	Reference voltage of sensor 2
8	OCD2_2	Over Current Detection channel 2 of sensor 2 (open drain)

(table continues...)

5 System design

Table 3 (continued) Evaluation board connector pinout

9	AOUT3	Analog output voltage of sensor 3
10	OCD1_3	Over Current Detection channel 1 of sensor 3 (open drain)
11	VREF3	Reference voltage of sensor 3
12	OCD2_3	Over Current Detection channel 2 of sensor 3 (open drain)
13	Reserved	Additional ADC input, connected to μ C XMC4700 P14_7 on the programmer board
14	VSENS	LDO enable signal. It can be shorted to V5 in order to enable the sensor supply
15	Reserved	Additional ADC input, connected to μ C XMC4700 P14_9 on the programmer board
16	V5	5 V supply voltage
17	Reserved	External trigger input, connected to μ C XMC4700 P4_0 on the programmer board
18	Reserved	-
19	SCL	Clock for communication with external EEPROM on Infineon's evaluation boards
20	GND	Ground connection
21	SDA	Data link for communication with external EEPROM on Infineon's evaluation boards
22	GND	Ground connection
23	-	-
24	Reserved	-

6 System performance

6 System performance

6.1 Test points

The output voltage of the three sensors, as well as the OCD signals have been measured from the evaluation board connector. Please refer to [Chapter 5.4](#) for the complete pinout of the evaluation board connector.

6.2 Test results

6.2.1 Measurement results

This section discusses the results of the measurements performed in the laboratory on the evaluation board. The following measurements have been performed:

1. Sensitivity drift and offset drift over temperature
2. Frequency response
3. Crosstalk
4. Thermal capability

6.2.1.1 Sensitivity drift and offset drift over temperature

The figures below show the TLE4972 evaluation board measurement results of sensitivity drift and offset over temperature when the sensor is placed in the nominal position. The results show extremely stable sensitivity and small offset across the whole temperature range. The absolute value of sensitivity used as target for calibration is shown in [Chapter 3.4](#).

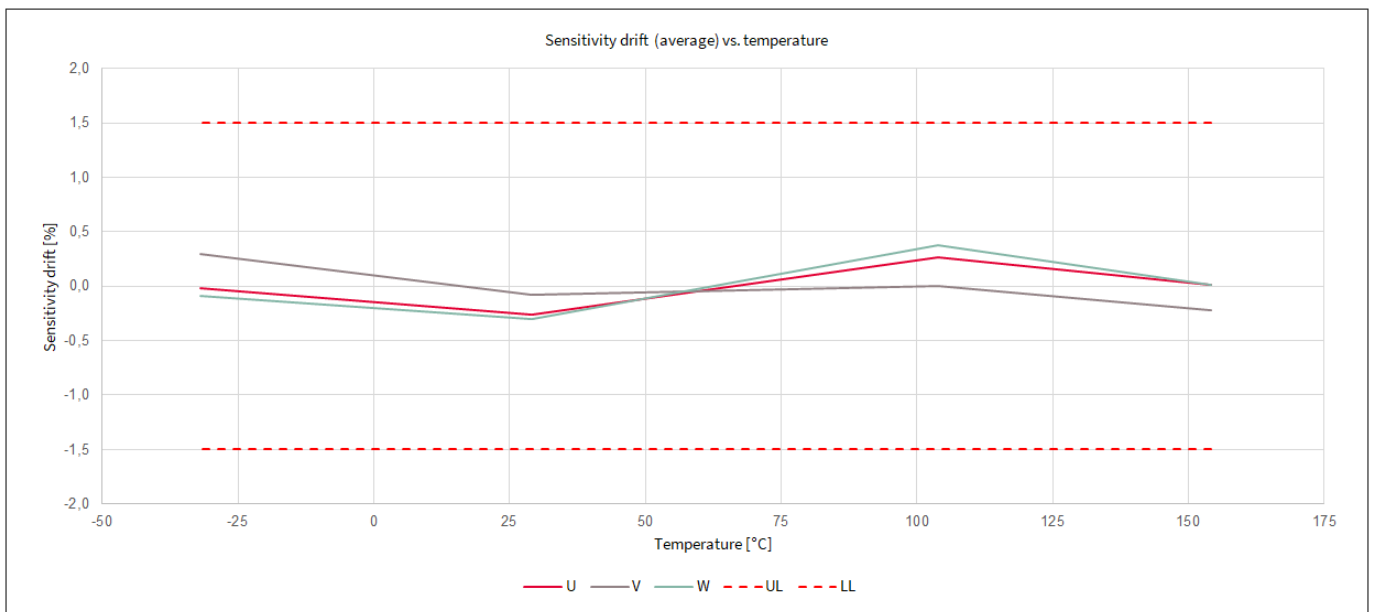

Figure 8 Sensitivity drift over temperature

6 System performance

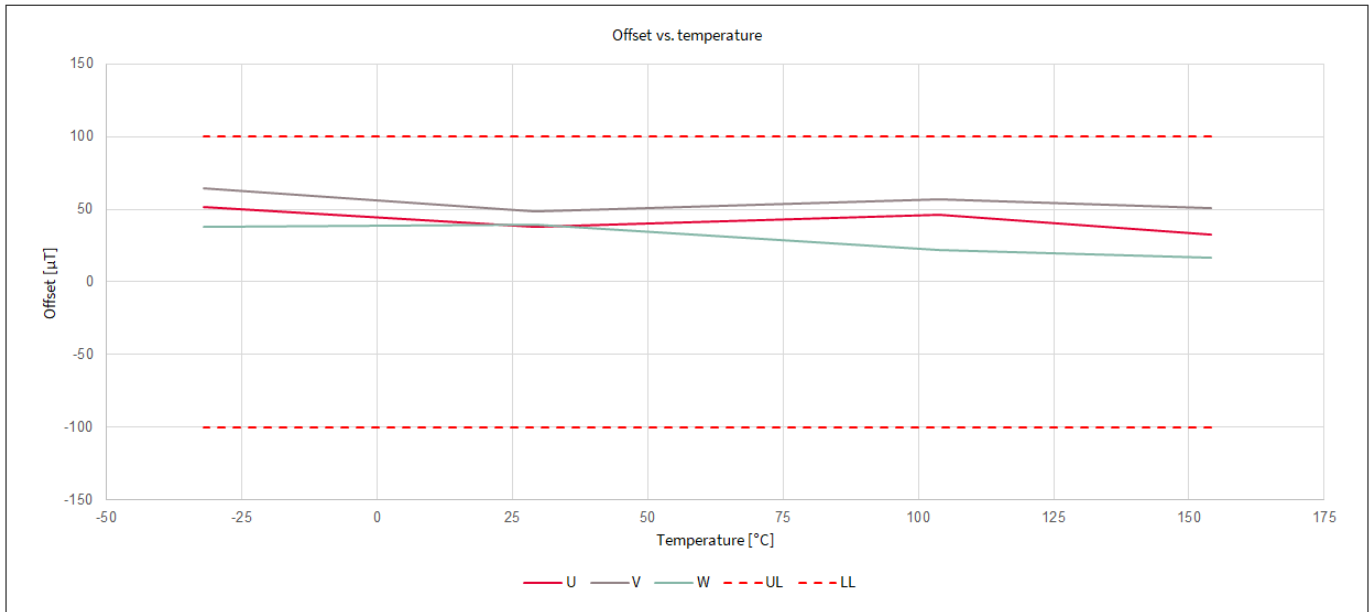

Figure 9 Offset over temperature

6.2.1.2 Frequency response

The figures below show the TLE4972 evaluation board measurement results of frequency response (gain and phase) when the sensor is placed in the nominal position. Two out of three sensors have been measured. A comparison with results from Finite Element Method (FEM) simulations is also provided. The Gain plots are normalized to the DC gain.

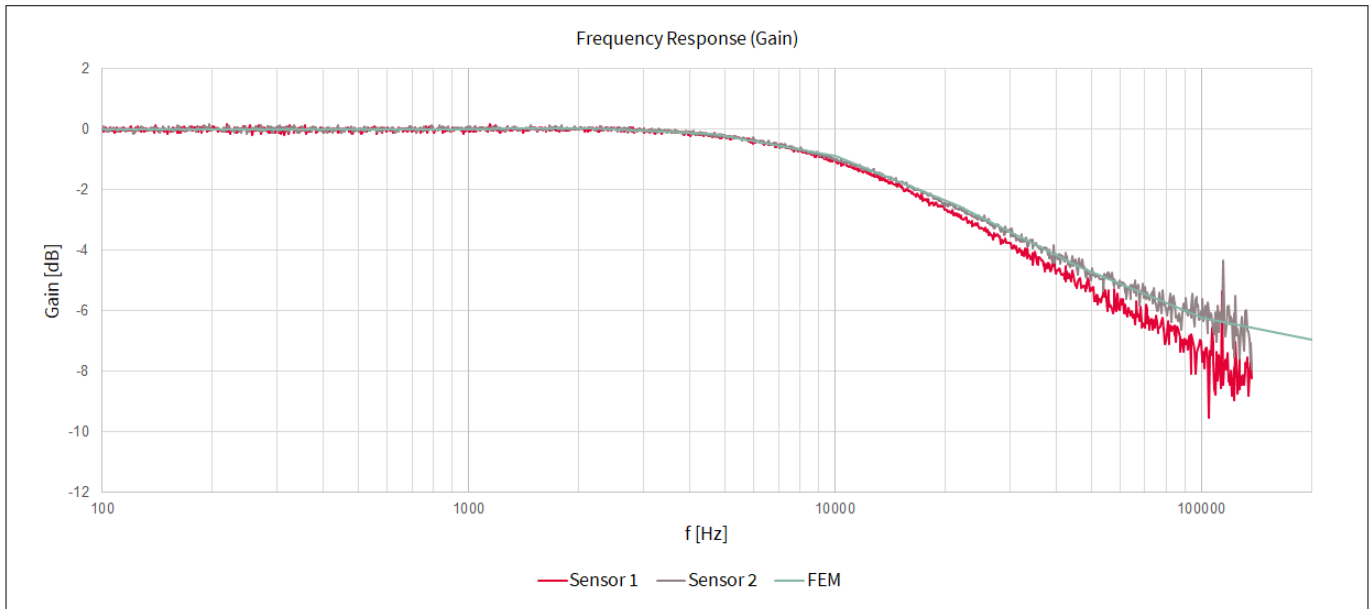

Figure 10 Frequency response (gain)

6 System performance

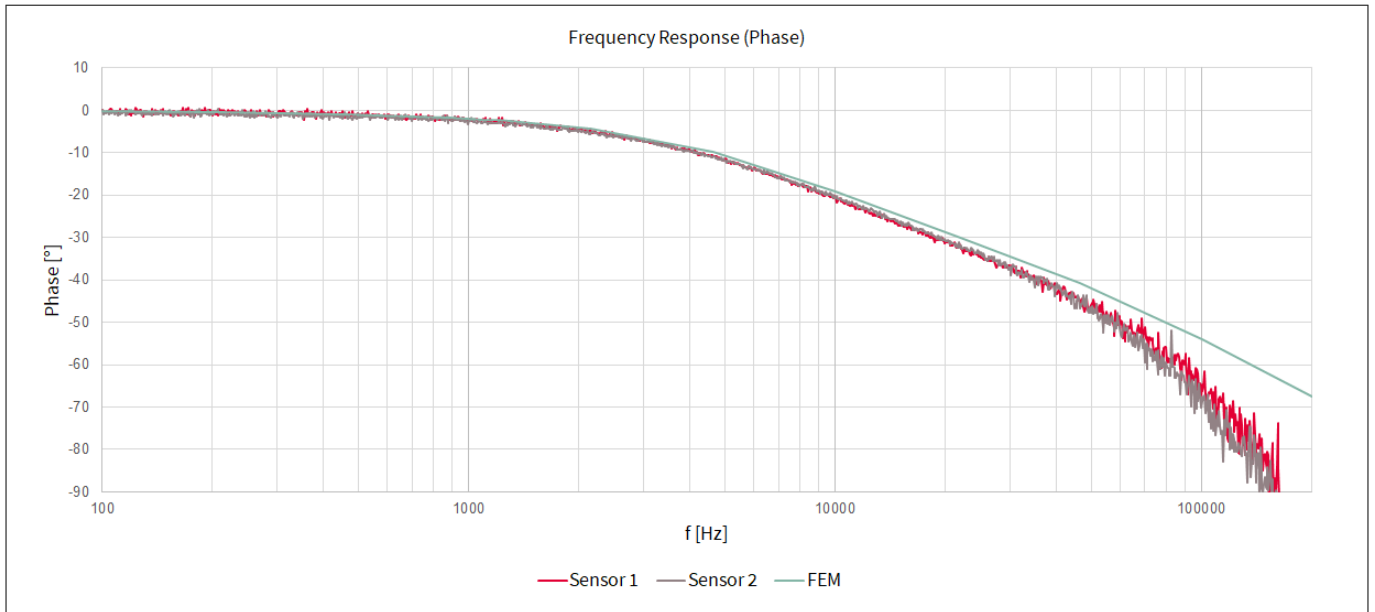

Figure 11 Frequency response (phase)

6.2.1.3 Crosstalk

The crosstalk is defined as the sensitivity error due to the magnetic stray field generated by the neighboring conductive lines. The crosstalk can be compensated with the “Matrix compensation method” in the microcontroller software. For further information, please refer to the programming board user guide [1] and device user manual [2].

Furthermore, the crosstalk can be reduced orienting the sensors differently with respect to each other, so that the respective sensing elements would see the same field coming from the neighboring conductive lines. Detailed explanation is provided in the application note [4].

The table below shows the sensitivity error due to the crosstalk before the compensation.

Table 4 Crosstalk

Active phase	S [%]		
	U	V	W
U	100,00	-1,14	-0,26
V	-1,18	100,00	-1,14
W	-0,27	-1,14	100,00

6 System performance

6.2.1.4 Thermal capability

The following figure shows the heating of the board and device when a current flows in the evaluation board. The temperature is read out by the sensor over time and the measurement is stopped when a temperature of approximately 80°C is detected. The measurement shows that a cooling of the board is needed, if high currents are applied.

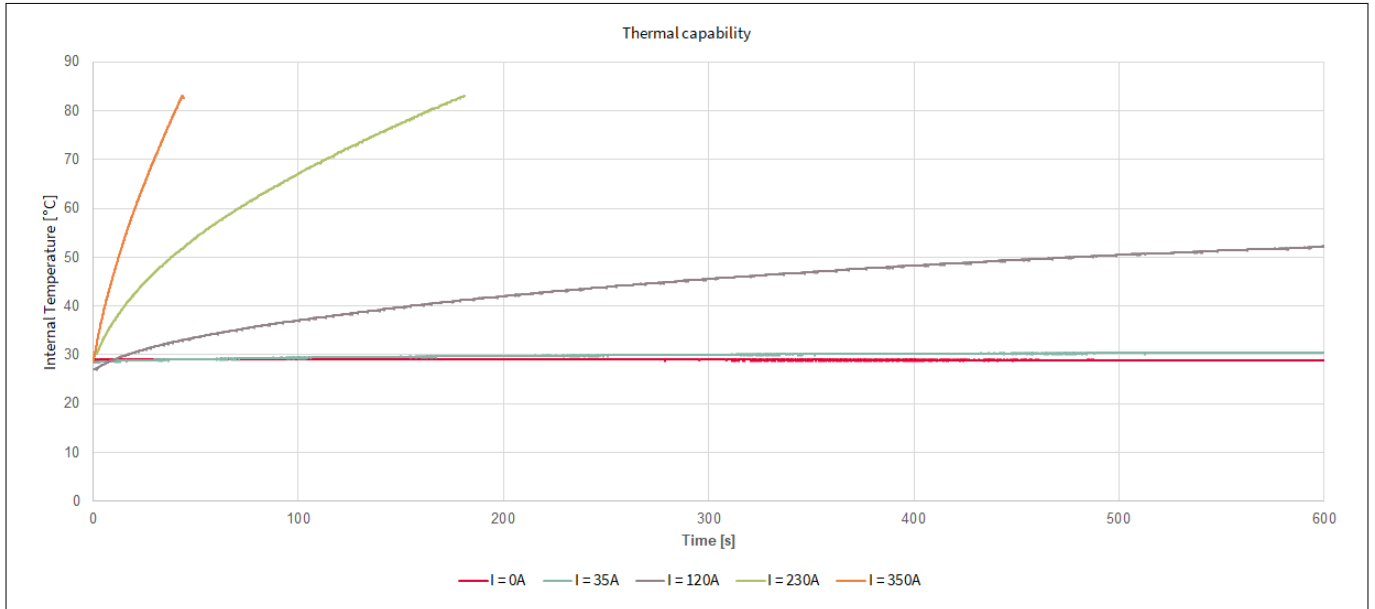

Figure 12 Thermal capability

6.2.2 Simulation results

This section discusses the results of the simulations performed in ANSYS Maxwell 3D on the evaluation board to complement the results from measurements. The following simulations have been performed:

1. Conductor and insertion resistance
2. Transfer factor error due to sensor displacement

6 System performance

6.2.2.1 Conductor and insertion resistance

The insertion resistance indicates the additional resistance caused by the sensing structure at 25°C. The simulations are performed with and without slit in the conductor by applying 1 A of current. Simulation results are shown in the figure below. Please note that the legend shows a voltage [V], which is equivalent to resistance [Ω], being the applied current 1 A.

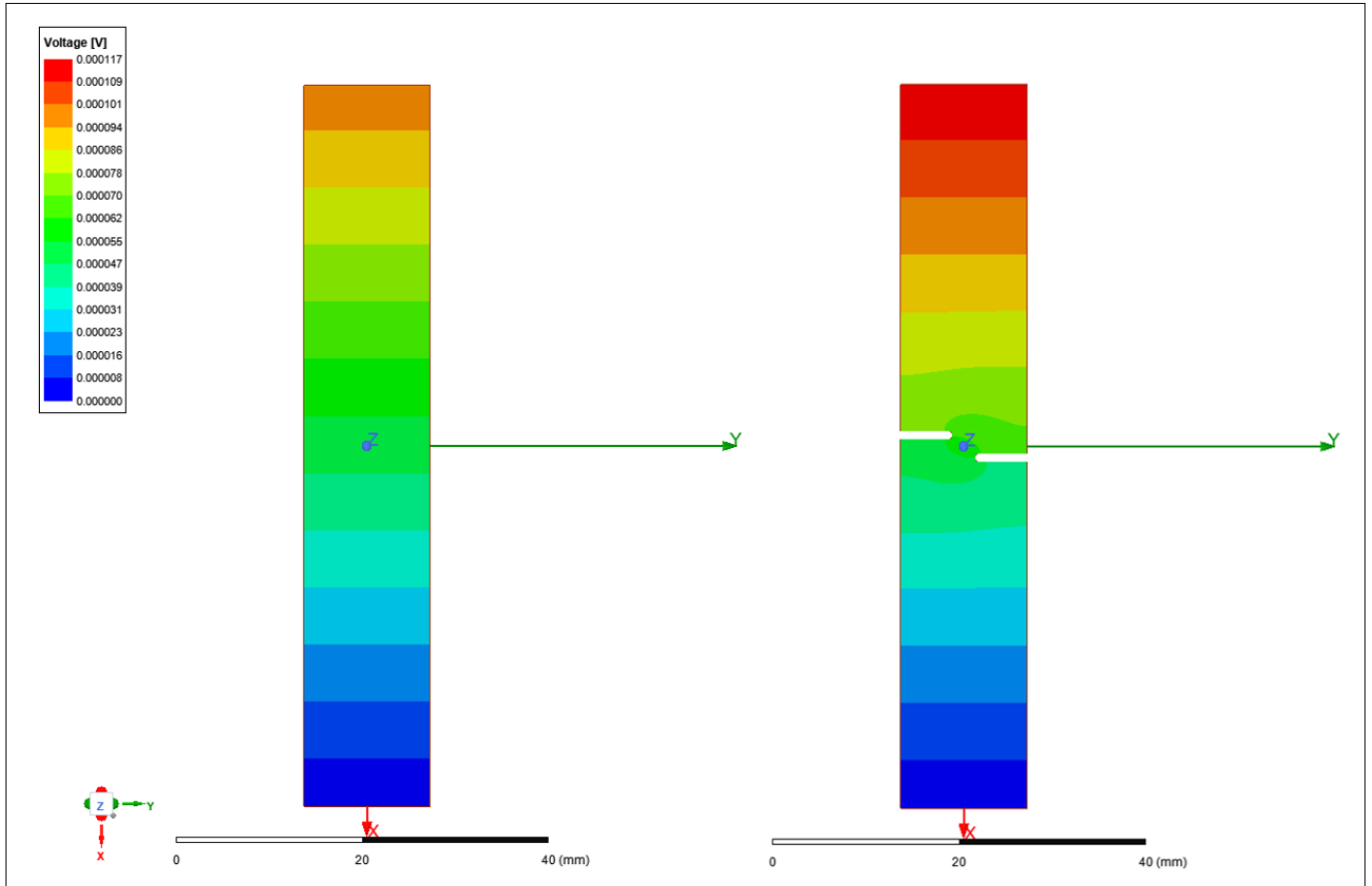

Figure 13 Conductor resistance, without slit (left) and with slit (right)

The table below shows the simulated resistance of the conductor with and without slit and the calculated insertion resistance.

Table 5 Evaluation Board Conductor Resistance

Parameter	Value
Conductor resistance without slit	100 $\mu\Omega$
Conductor resistance with slit	117 $\mu\Omega$
Insertion resistance	17 $\mu\Omega$
Conductor resistance increase	17%

6 System performance

6.2.2.2 Transfer factor error due to sensor displacement

This following figures show the transfer factor variation due to sensor displacement in the x, y, and z-axis direction. The transfer factor is defined in $\mu\text{T}/\text{A}$ and the typical value is shown in [Chapter 3.4](#).

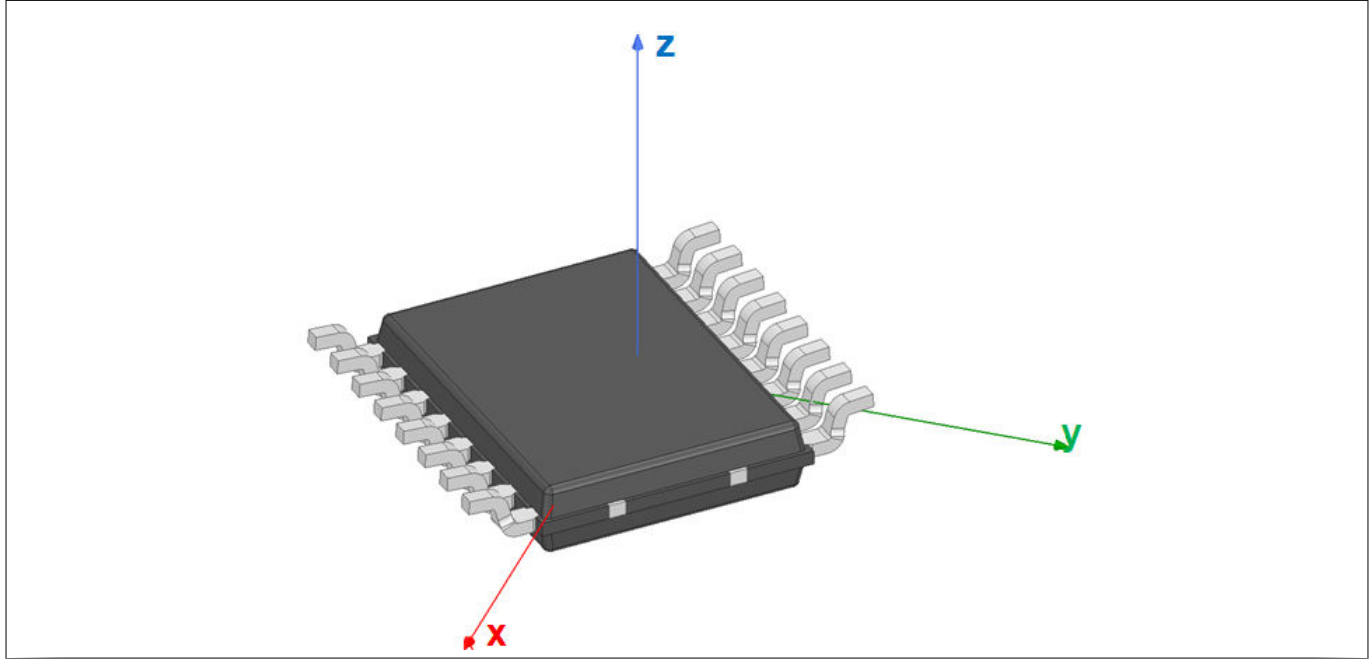

Figure 14 Reference system for sensor displacement simulations

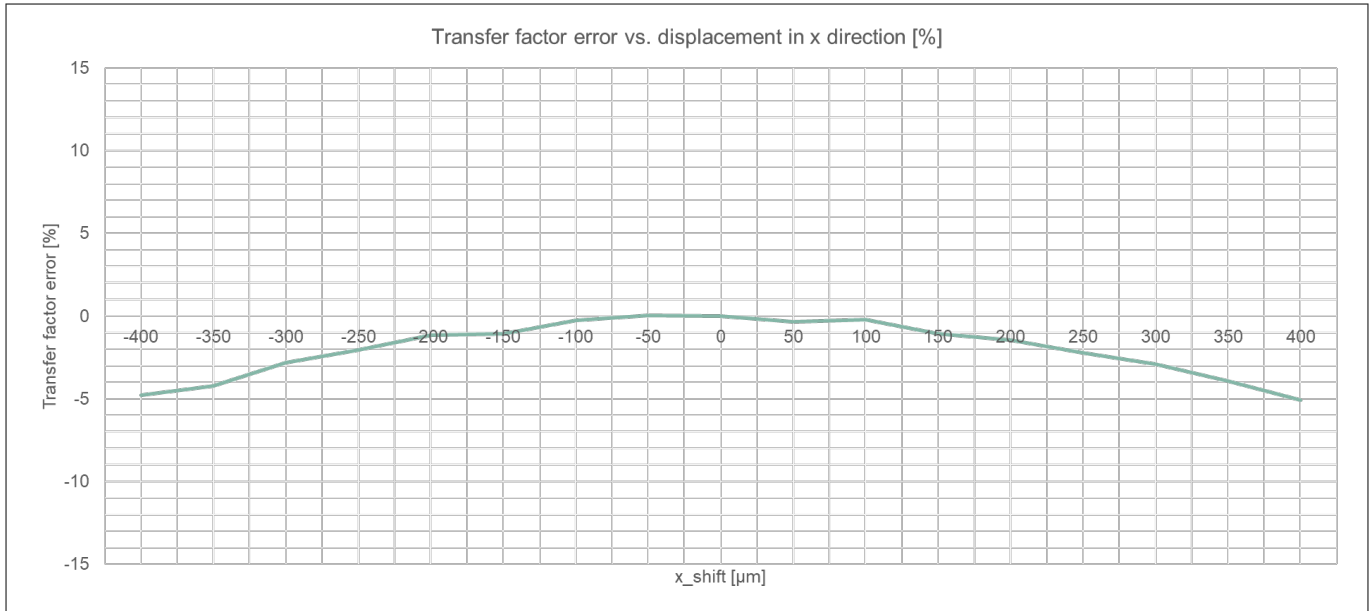

Figure 15 Transfer factor error due to sensor displacement in x direction

6 System performance

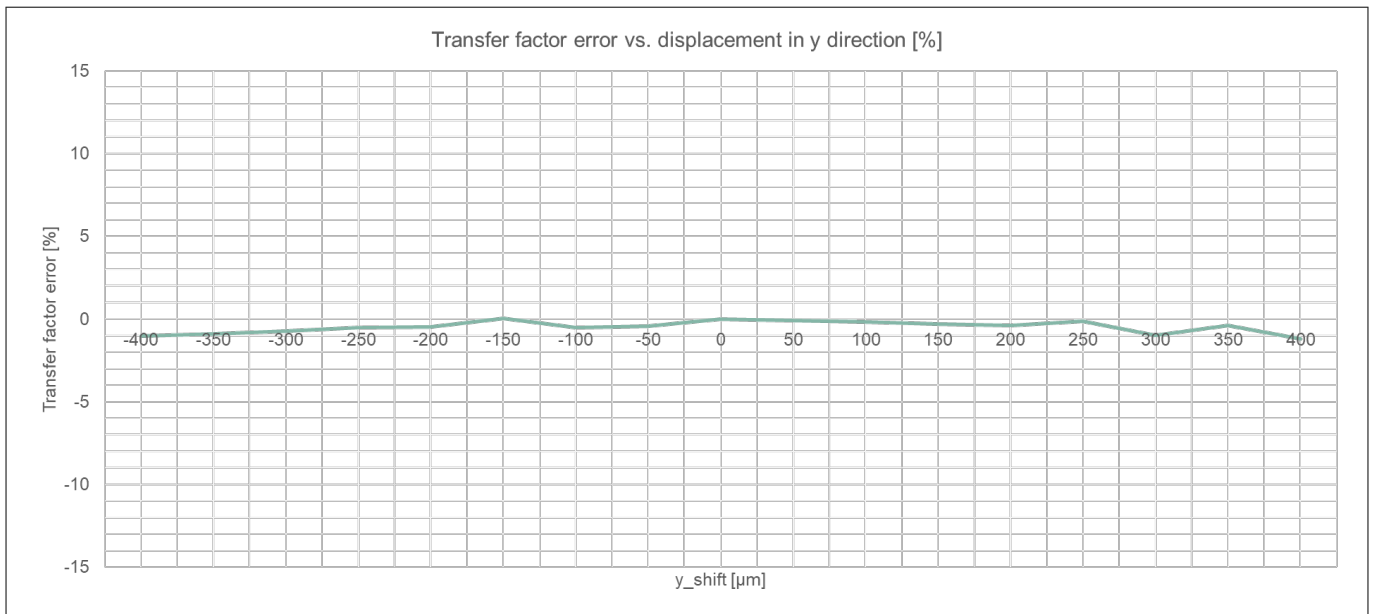

Figure 16 Transfer factor error due to sensor displacement in y direction

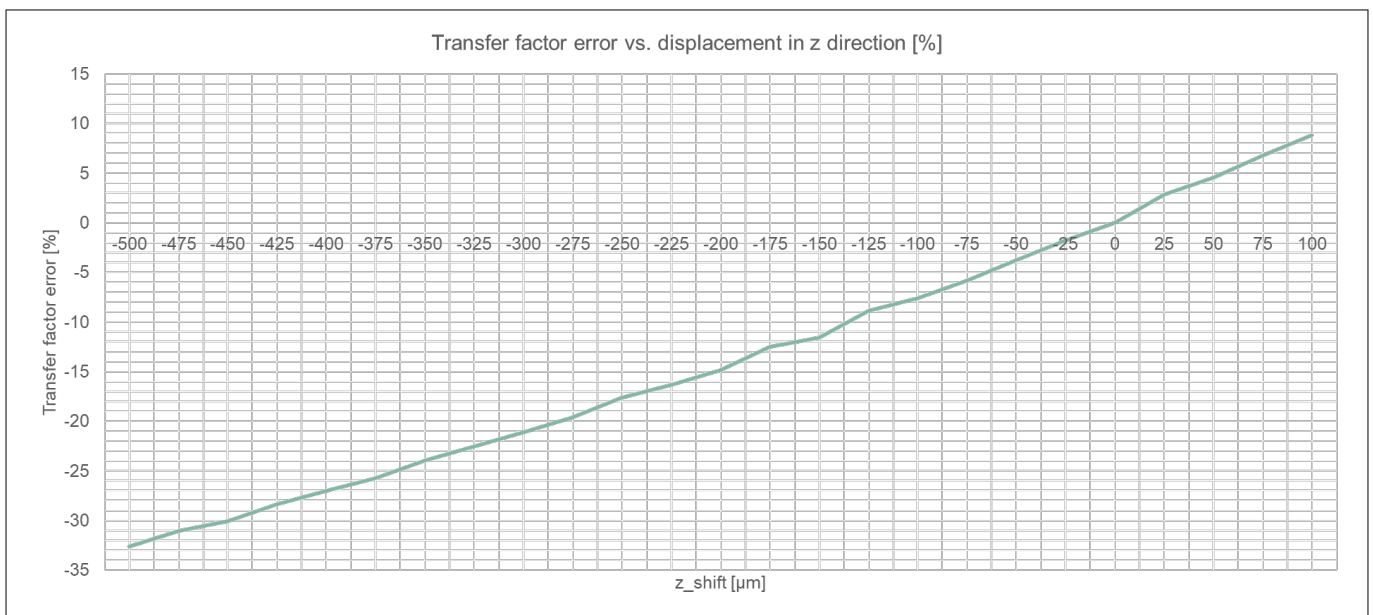

Figure 17 Transfer factor error due to sensor displacement in z direction

7 References and appendices

7.1 Abbreviations and definitions

Notation	Description
AC	Alternating Current
CE	European Conformity
DC	Direct Current
EMC	Electro-Magnetic Compatibility
EMI	Electro-Magnetic Interference
EEPROM	Electrically Erasable Programmable Read-Only Memory
ESD	Electro-Static Discharge
FEM	Finite Element Method
GUI	Graphical User Interface
LDO	Low Drop Out
LV	Low Voltage
OCD	Over Current Detection
PCB	Printed Circuit Board
PCN	Process Change Notification
PD	Product Discontinuation
PWD	Product Withdraw
RMA	Returned Material Analysis
SCL	Serial Clock
SDA	Serial Data
UL	Underwriters Laboratories
USB	Universal Serial Bus

7.2 References

- [1] Infineon-TLE4972-Current_Sensor_Programmer_User_guide-vxx_xx-EN
- [2] Infineon-TLE4972-User_manual-vxx_xx-EN
- [3] Infineon-TLE4972AE35S5-DS-vxx_xx-EN, Infineon-TLE4972AE35D5-DS-vxx_xx-EN
- [4] Infineon-TLE4972-Sensing_Structure_Design-AN-vxx_xx-EN

8 Revision history

8 Revision history

Table 6 Revision History

Document version	Date of release	Description of changes
1.1	2023-02-28	- In order to enable sensor supply, pin 16 and 14 of connector P1 must be connected to 5 V; - Fixed error in transfer factor error due to sensor displacement plots; - Editorial changes.
1.0	2022-04-14	Initial release

Trademarks

All referenced product or service names and trademarks are the property of their respective owners.

Edition 2023-02-28

Published by

Infineon Technologies AG

81726 Munich, Germany

© 2023 Infineon Technologies AG

All Rights Reserved.

Do you have a question about any aspect of this document?

Email: erratum@infineon.com

Document reference

IFX-exc1649922313605

Important notice

The information given in this document shall in no event be regarded as a guarantee of conditions or characteristics ("Beschaffheitsgarantie").

With respect to any examples, hints or any typical values stated herein and/or any information regarding the application of the product, Infineon Technologies hereby disclaims any and all warranties and liabilities of any kind, including without limitation warranties of non-infringement of intellectual property rights of any third party.

In addition, any information given in this document is subject to customer's compliance with its obligations stated in this document and any applicable legal requirements, norms and standards concerning customer's products and any use of the product of Infineon Technologies in customer's applications.

The data contained in this document is exclusively intended for technically trained staff. It is the responsibility of customer's technical departments to evaluate the suitability of the product for the intended application and the completeness of the product information given in this document with respect to such application.

Warnings

Due to technical requirements products may contain dangerous substances. For information on the types in question please contact your nearest Infineon Technologies office.

Except as otherwise explicitly approved by Infineon Technologies in a written document signed by authorized representatives of Infineon Technologies, Infineon Technologies' products may not be used in any applications where a failure of the product or any consequences of the use thereof can reasonably be expected to result in personal injury.

Mouser Electronics

Authorized Distributor

Click to View Pricing, Inventory, Delivery & Lifecycle Information:

[Infineon:](#)

[TLE4972EVALINLAYTOBO1](#)