

# MOTIX™ TLE9189 motor gate driver IC evaluation kit

## User guide

Z8F80673078

## About this document

### Scope and purpose

This user guide contains information about the MOTIX™ TLE9189 motor gate driver IC evaluation kit, which is designed to evaluate hardware and software functionality of the MOTIX™ TLE9189 motor gate driver *integrated circuit (IC)*. This user guide provides extensive information about the kit's layout, jumper settings, interfaces, and debug options.

The MOTIX™ TLE9189 motor gate driver IC evaluation kit can be used during design-in, for evaluation and measurement of characteristics, and to test features and configuration options.

**Note:** The *printed circuit board (PCB)* and the auxiliary circuits are NOT optimized for final customer design.

### Intended audience

This document is intended for anyone using the MOTIX™ TLE9189 motor gate driver IC evaluation kit.

---

**Important notice****Important notice**

**“Evaluation Boards and Reference Boards” shall mean products embedded on a printed circuit board (PCB) for demonstration and/or evaluation purposes, which include, without limitation, demonstration, reference and evaluation boards, kits and design (collectively referred to as “Reference Board”).**

**Environmental conditions have been considered in the design of the Evaluation Boards and Reference Boards provided by Infineon Technologies. The design of the Evaluation Boards and Reference Boards has been tested by Infineon Technologies only as described in this document. The design is not qualified in terms of safety requirements, manufacturing and operation over the entire operating temperature range or lifetime.**

**The Evaluation Boards and Reference Boards provided by Infineon Technologies are subject to functional testing only under typical load conditions. Evaluation Boards and Reference Boards are not subject to the same procedures as regular products regarding returned material analysis (RMA), process change notification (PCN) and product discontinuation (PD).**

**Evaluation Boards and Reference Boards are not commercialized products, and are solely intended for evaluation and testing purposes. In particular, they shall not be used for reliability testing or production. The Evaluation Boards and Reference Boards may therefore not comply with CE or similar standards (including but not limited to the EMC Directive 2004/EC/108 and the EMC Act) and may not fulfill other requirements of the country in which they are operated by the customer. The customer shall ensure that all Evaluation Boards and Reference Boards will be handled in a way which is compliant with the relevant requirements and standards of the country in which they are operated.**

**The Evaluation Boards and Reference Boards as well as the information provided in this document are addressed only to qualified and skilled technical staff, for laboratory usage, and shall be used and managed according to the terms and conditions set forth in this document and in other related documentation supplied with the respective Evaluation Board or Reference Board.**

**It is the responsibility of the customer’s technical departments to evaluate the suitability of the Evaluation Boards and Reference Boards for the intended application, and to evaluate the completeness and correctness of the information provided in this document with respect to such application.**

**The customer is obliged to ensure that the use of the Evaluation Boards and Reference Boards does not cause any harm to persons or third party property.**

**The Evaluation Boards and Reference Boards and any information in this document is provided "as is" and Infineon Technologies disclaims any warranties, express or implied, including but not limited to warranties of non-infringement of third party rights and implied warranties of fitness for any purpose, or for merchantability.**

**Infineon Technologies shall not be responsible for any damages resulting from the use of the Evaluation Boards and Reference Boards and/or from any information provided in this document. The customer is obliged to defend, indemnify and hold Infineon Technologies harmless from and against any claims or damages arising out of or resulting from any use thereof.**

**Infineon Technologies reserves the right to modify this document and/or any information provided herein at any time without further notice.**

Safety precautions

Safety precautions

**Note:** Please note the following warnings regarding the hazards associated with development systems.

**Table 1** Safety precautions

	<p><b>Caution:</b> The heat sink and device surfaces of the evaluation or reference board may become hot during testing. Hence, necessary precautions are required while handling the board. Failure to comply may cause injury.</p>
	<p><b>Caution:</b> Only personnel familiar with the drive, power electronics and associated machinery should plan, install, commission and subsequently service the system. Failure to comply may result in personal injury and/or equipment damage.</p>
	<p><b>Caution:</b> The evaluation or reference board contains parts and assemblies sensitive to electrostatic discharge (ESD). Electrostatic control precautions are required when installing, testing, servicing or repairing the assembly. Component damage may result if ESD control procedures are not followed. If you are not familiar with electrostatic control procedures, refer to the applicable ESD protection handbooks and guidelines.</p>
	<p><b>Caution:</b> A drive that is incorrectly applied or installed can lead to component damage or reduction in product lifetime. Wiring or application errors such as under-sizing the motor, supplying an incorrect or inadequate DC supply, or excessive ambient temperatures may result in system malfunction.</p>
	<p><b>Caution:</b> The evaluation or reference board is shipped with packing materials that need to be removed prior to installation. Failure to remove all packing materials that are unnecessary for system installation may result in overheating or abnormal operating conditions.</p>

## Table of contents

	<b>About this document</b> .....	1
	<b>Important notice</b> .....	2
	<b>Safety precautions</b> .....	3
	<b>Table of contents</b> .....	4
<b>1</b>	<b>The board at a glance</b> .....	6
1.1	Delivery content .....	6
1.2	Block diagram .....	7
1.3	Main features .....	9
1.4	Technical data .....	9
<b>2</b>	<b>System and functional description</b> .....	11
2.1	Board information .....	11
2.1.1	Connectors .....	11
2.1.2	Test points .....	12
2.1.3	LEDs .....	13
2.1.4	Jumpers .....	14
2.2	Interfaces .....	15
2.2.1	Motor power stage .....	15
2.2.2	Current sense amplifier (CSA) .....	15
2.2.3	Motor position sensors .....	16
2.2.3.1	Encoder .....	16
2.2.3.2	Hall sensor .....	17
2.2.3.3	Tunneling magnetoresistance sensor .....	17
2.2.4	Push button .....	18
2.2.5	CAN .....	19
2.2.6	Tracebox .....	19
2.2.7	Debug interfaces .....	20
2.2.8	GPIO .....	21
<b>3</b>	<b>Assembly view</b> .....	22
<b>4</b>	<b>Assembly options</b> .....	23
<b>5</b>	<b>Software toolchain</b> .....	25
<b>6</b>	<b>Design files</b> .....	26
6.1	Schematics of the MOTIX™ TLE9189 motor gate driver IC evaluation kit .....	26
6.2	Layout of the MOTIX™ TLE9189 motor gate driver IC evaluation kit .....	36
6.3	Bill of materials .....	41
<b>7</b>	<b>Glossary additional abbreviations</b> .....	51
7.1	Glossary .....	51
7.2	Additional abbreviations .....	52



**Table of contents**

<b>8</b>	<b>References</b> .....	<b>53</b>
	<b>Revision history</b> .....	<b>54</b>
	<b>Disclaimer</b> .....	<b>55</b>

## **1 The board at a glance**

### **1 The board at a glance**

This board is designed as a simple, easy-to-use tool to familiarize yourself with Infineon's MOTIX™ TLE9189 motor gate driver IC device.

The evaluation kit, available for VQFN48 and TQFP48 package devices, enables you to test and evaluate both variants of the MOTIX™ TLE9189 motor gate driver IC.

The 32-bit TriCore™ AURIX™ TC364DP is used as the microcontroller. For software debugging, the board includes a *universal serial bus (USB)* port to use the on-board debugger and debug interface for DAP.

The board is protected against reverse polarity of the input voltage supply. A battery *light-emitting diode (LED)* indicates that the board is correctly connected to the battery supply. The reverse polarity protection circuit secures the board from damage by an inverse connection. The logic power supply for the microcontroller and MOTIX™ TLE9189 motor gate driver IC is handled by an OPTIREG™ PMIC TLF35585QV.

A B6-bridge with OptiMOS™ 6 40 V MOSFETs is placed on the board to drive a 3-phase motor. Motor phases can easily be connected using a wire-to-board terminal block, without needing any additional tools. You can operate the evaluation kit using standard laboratory equipment.

To evaluate the basic behavior of the MOTIX™ TLE9189 motor gate driver IC, use the Configuration Wizard for MOTIX™ TLE9189 motor gate driver IC in combination with the TLE9189 evaluation kit, see chapter [Chapter 5](#).

Access the tool by clicking: [here](#).

#### **1.1 Delivery content**

The MOTIX™ TLE9189 motor gate driver IC evaluation kit is delivered in the VQFN48 or the TQFP48 pin package device with a *USB* cable to connect the board to a PC.

**1 The board at a glance**

**1.2 Block diagram**

The block diagram below shows an overview of the main modules and their connections on the evaluation kit.

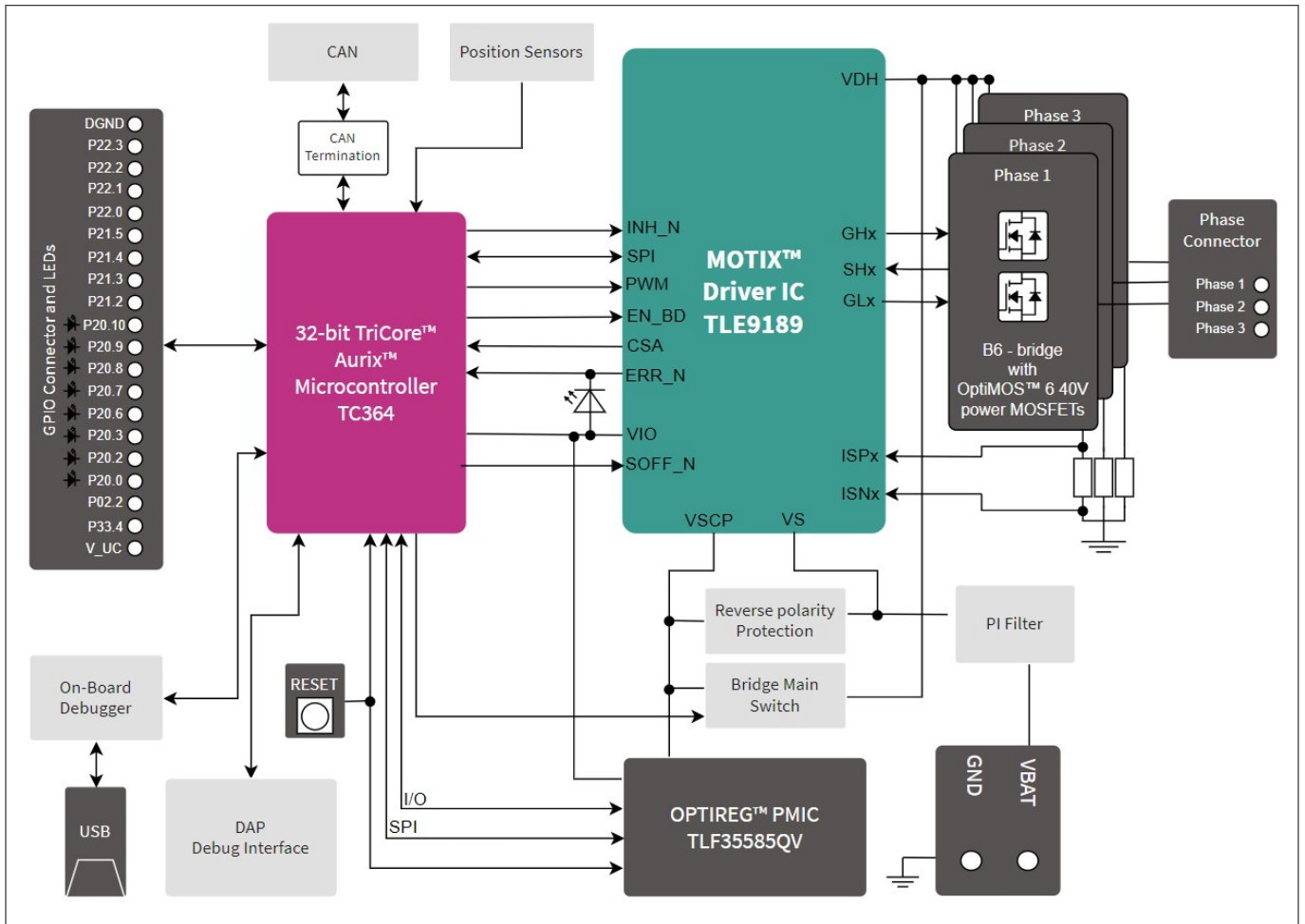

**Figure 1 Block diagram**

**1 The board at a glance**

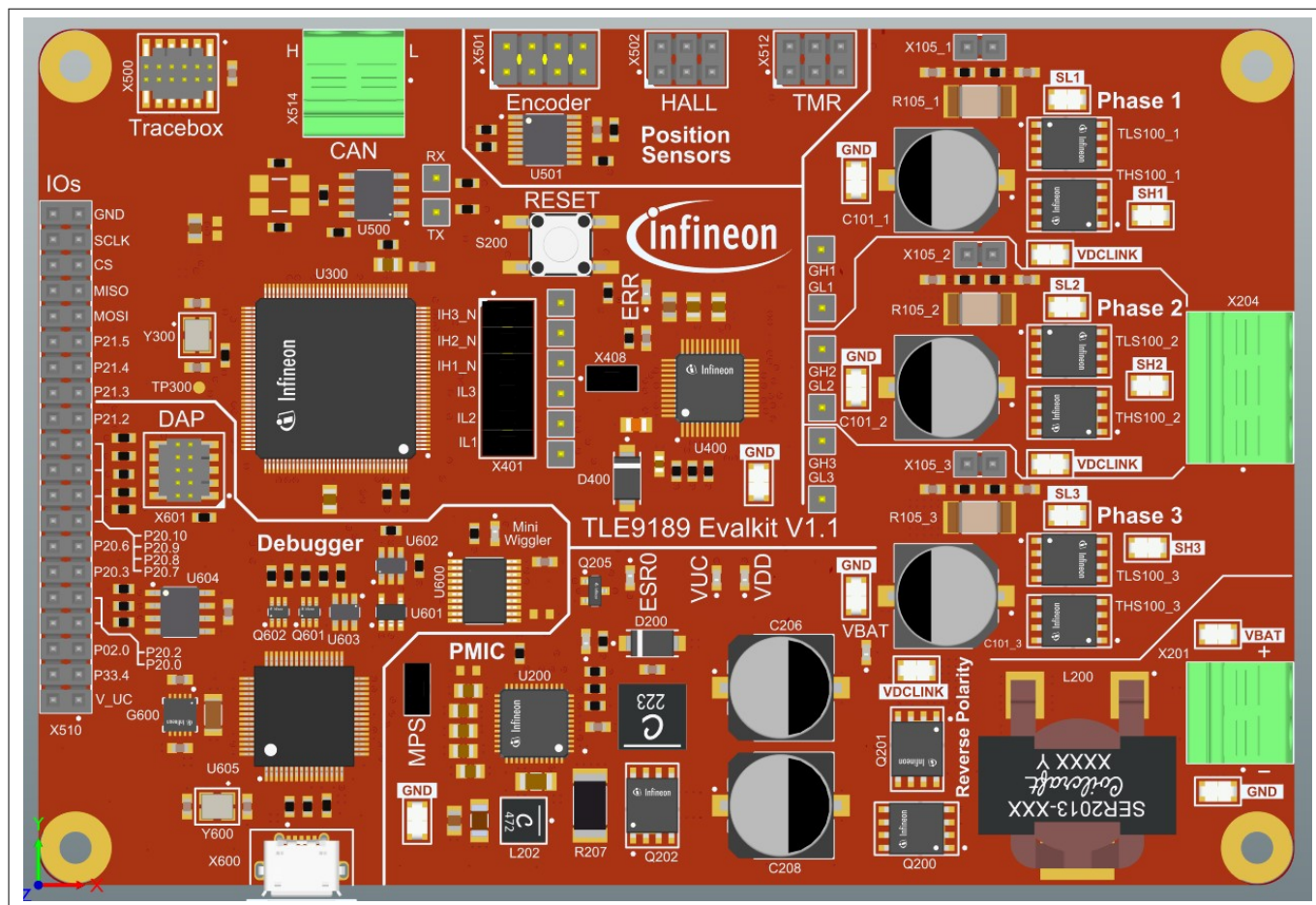

**Figure 2 Evaluation kit floor plan: top view**



1 The board at a glance

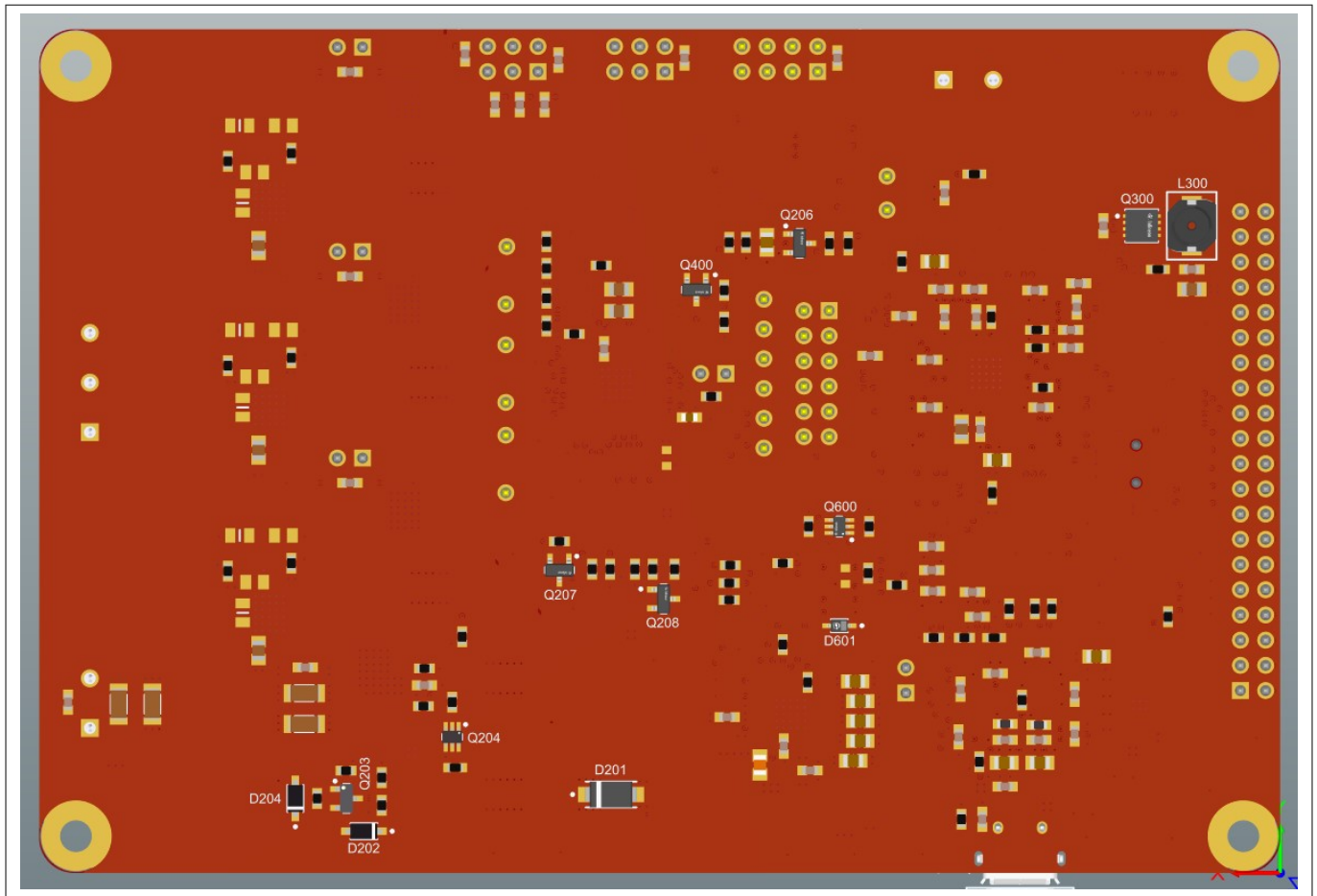

Figure 3 Evaluation kit floor plan: bottom view

1.3 Main features

- 32-bit TriCore™ AURIX™ TC364DP used as microcontroller
- On-board debugger for the microcontroller with a USB connection
- Power management with OPTIREG™ PMIC TLF35585QV
- Supply voltage including Pi filter and reverse polarity protection
- Controllable bridge disconnect MOSFET
- Motor power stage, including a B6-bridge with OptiMOS™ 6 40 V power MOSFETs and a motor phase connector that requires no additional tools
- [general purpose input output \(GPIO\)](#) pin connector and push button available for the microcontroller
- Pin headers available for motor position sensors

1.4 Technical data

Technical data is specified in [Table 2](#).

The maximum supply current is limited by the input filter coil. The maximum motor current is limited by the shunt resistors and the phase connectors.

Table 2 Technical data

Supply voltage	Typ. 13.5 V, Max. 28 V
Supply current	DC 18 A
<b>(table continues...)</b>	

**1 The board at a glance**

**Table 2** (continued) **Technical data**

Motor current	Max. 10 A peak
Motor power	Max 250 W
Pin ports	5 V

2 System and functional description

2 System and functional description

2.1 Board information

2.1.1 Connectors

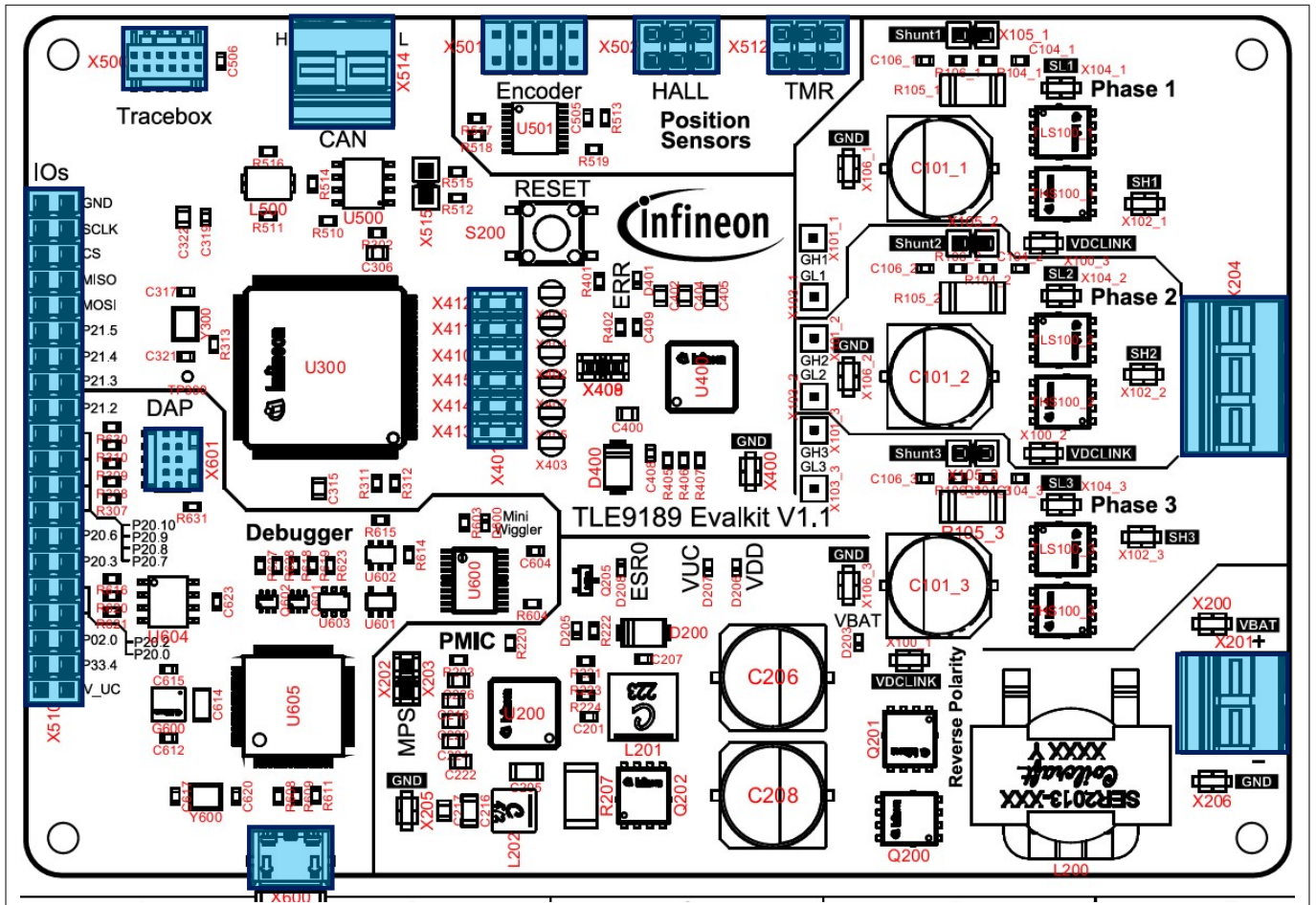

Figure 4 Connectors

Table 3 Connectors

Connectors	Application
VBAT, <i>ground (GND)</i>	Wire-to-board terminal block for power supply and ground.
Phase 1, 2, 3	Wire-to-board terminal block for motor connection. The three push in connections for phase 1 to 3 provide access to the motor power stage and are intended to connect a motor.
Interfaces	Connectors to communicate with the microcontroller: <ul style="list-style-type: none"> <li><i>controller area network (CAN)</i> communication</li> <li>Tracebox interface</li> <li>µIO interface</li> </ul>

(table continues...)

2 System and functional description

Table 3 (continued) Connectors

Connectors	Application
Position sensors	Available interfaces for: <ul style="list-style-type: none"> <li>Hall sensors</li> <li>Encoder</li> <li>TMR sensors</li> </ul>
Debugger	Available debug interfaces to the microcontroller: <ul style="list-style-type: none"> <li>On-board miniWiggler with micro <i>USB</i> interface</li> <li>DAP connector</li> </ul>
IOs	<ul style="list-style-type: none"> <li>Double row pin headers as a digital interface to the microcontroller with both rows connected to the same signals. The first pin pair connected to DGND and the last pin pair to digital supply</li> </ul>
IL <sub>x</sub> , IH <sub>x</sub> _N pins	Double row pin headers as digital interface between the microcontroller and the inputs signals IL <sub>x</sub> and IH <sub>x</sub> _N of the TLE9189. Jumpers must be placed to make a connection between microcontroller and the TLE9189.

2.1.2 Test points

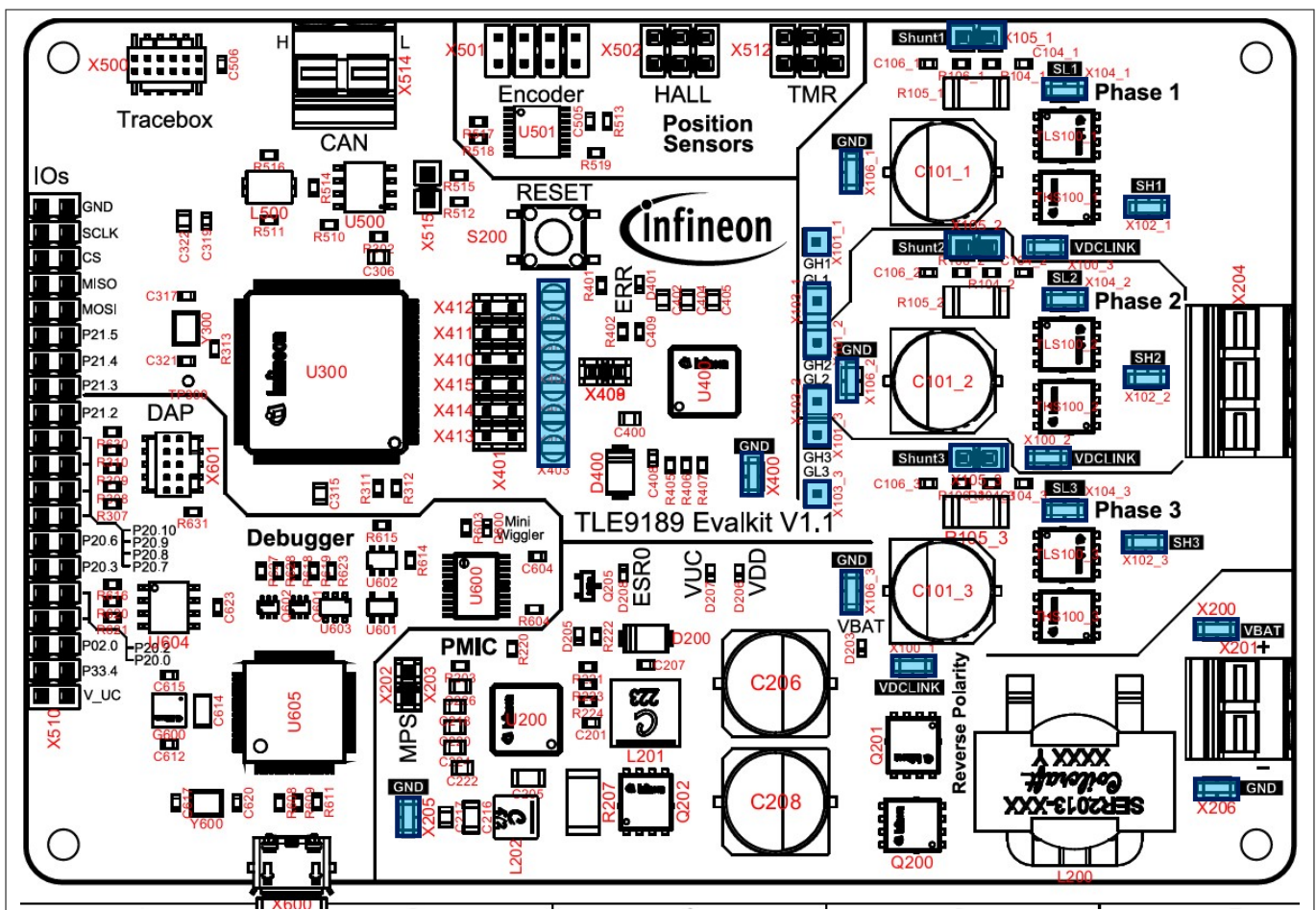

Figure 5 Test points

**2 System and functional description**

**Table 4 Test points**

Test points	Application
GND	Test points to connect to ground when measuring power stage signals. This ground signal is more stable than PGND.
VBAT	Test points to measure battery voltage.
SL1, SL2, SL3	Test points to measure source-low-side in each output phase.
SH1, SH2, SH3	Test points to measure source-high-side in each output phase.
X105_1, X105_2, X105_3	Test points to measure voltage drop across each shunt resistor. Each connector has two pins with a 2.54 mm pitch to directly connect differential probe with a 2.54 mm pitch. The test points are placed behind the filter capacitors at shunt.
GL1, GL2, GL3	Test points to measure gate-low-side in each output phase.
GH1, GH2, GH3	Test points to measure gate-high-side in each output phase.
VDCLINK	Test points to measure <i>direct current (DC)</i> -link voltage.
X402, X404, X406	Test point to measure the input pins of the 3 high-side.
X403, X405, X407	Test point to measure the input pins of the 3 low-side.

**2.1.3 LEDs**

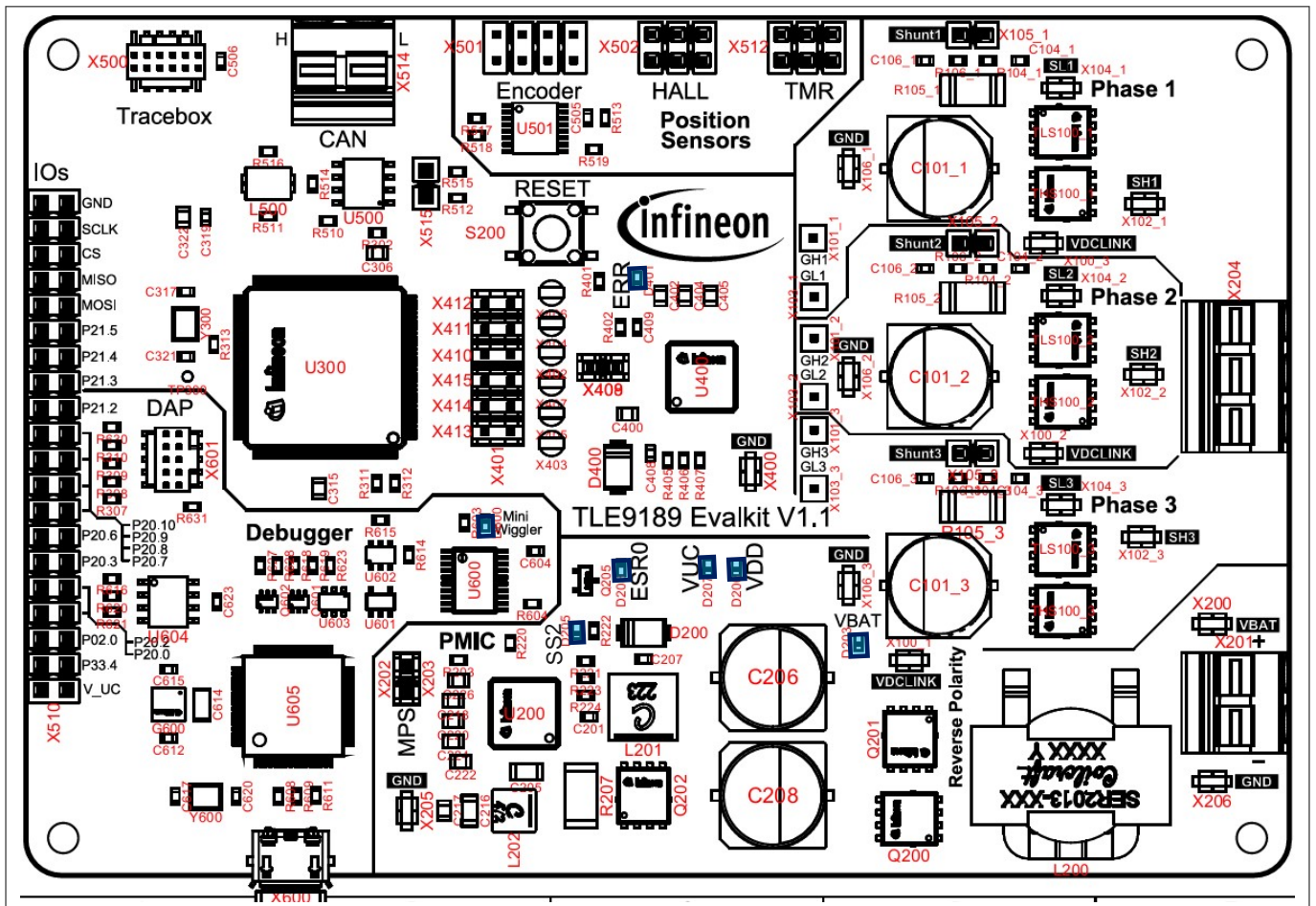

**Figure 6 LEDs**

**2 System and functional description**

**Table 5 LEDs**

LEDs	Application
ERR	Indicates the TLE9189 ERR_N pin state
miniWiggler	Indicates the operation of the on board miniWiggler
ESRO	Indicates the TC364DP ESRO pin state
SS2	Indicates the TLF35585QV SS2 pin state
VDD	Indicates if VDD voltage is active
VUC	Indicates if VUC voltage is active

**2.1.4 Jumpers**

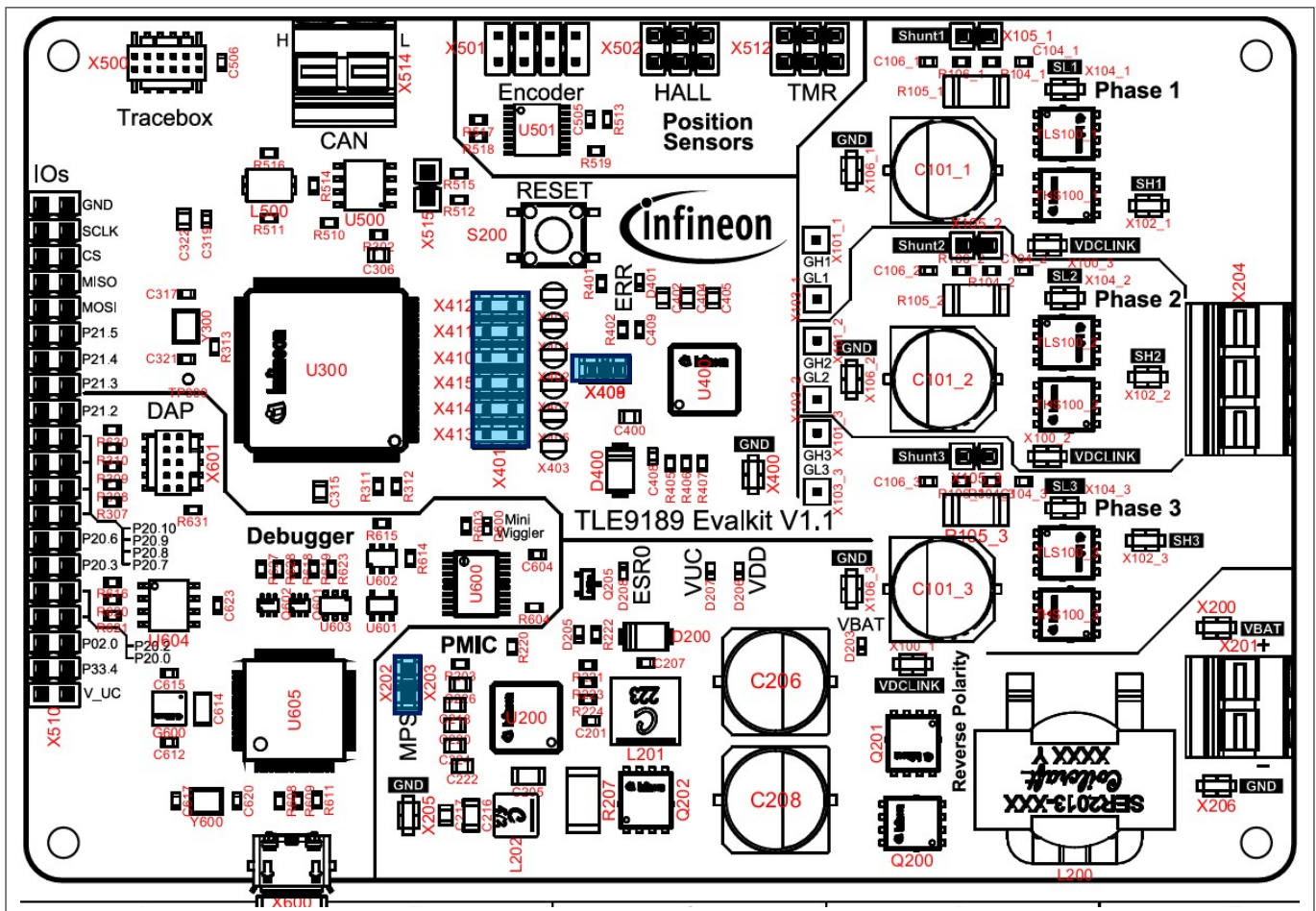

**Figure 7 Jumpers**

**Table 6 Jumpers**

Jumpers	Application
X412	Set the jumper to connect pin P02.6 to pin IH1_N of the TLE9189
X411	Set the jumper to connect pin P02.5 to pin IH2_N pin of the TLE9189
X410	Set the jumper to connect pin P02.4 to pin IH3_N of the TLE9189
X415	Set the jumper to connect pin P02.3 to pin IL3 of the TLE9189

**(table continues...)**

**2 System and functional description**

**Table 6 (continued) Jumpers**

Jumpers	Application
X414	Set the jumper to connect pin P02.2 to pin IL2 of the TLE9189
X413	Set the jumper to connect pin P02.1 to pin IL1 of the TLE9189
X409	Set the jumper to connect SOFF_N to pin P00.0
X202	Set the jumper to pull MPS pin to V_VR. This can be done to enable PMIC without needing <i>serial peripheral interface (SPI)</i> communication

**2.2 Interfaces**

**2.2.1 Motor power stage**

Three MOSFET half-bridges are placed on the board to drive a three-phase motor. Each half-bridge consists of two N-channel MOSFETs (THS100\_x, TLS100\_x) with a gate-source resistor (R101\_x, R103\_x). At VDCLINK for each motor phase, a decoupling capacitor (C100\_x) and a *DC*-link capacitor (C101\_x) are placed.

Additionally, there are placement options for snubbers (R101\_x + C102\_x, R102\_x + C103\_x). These components are not populated by default.

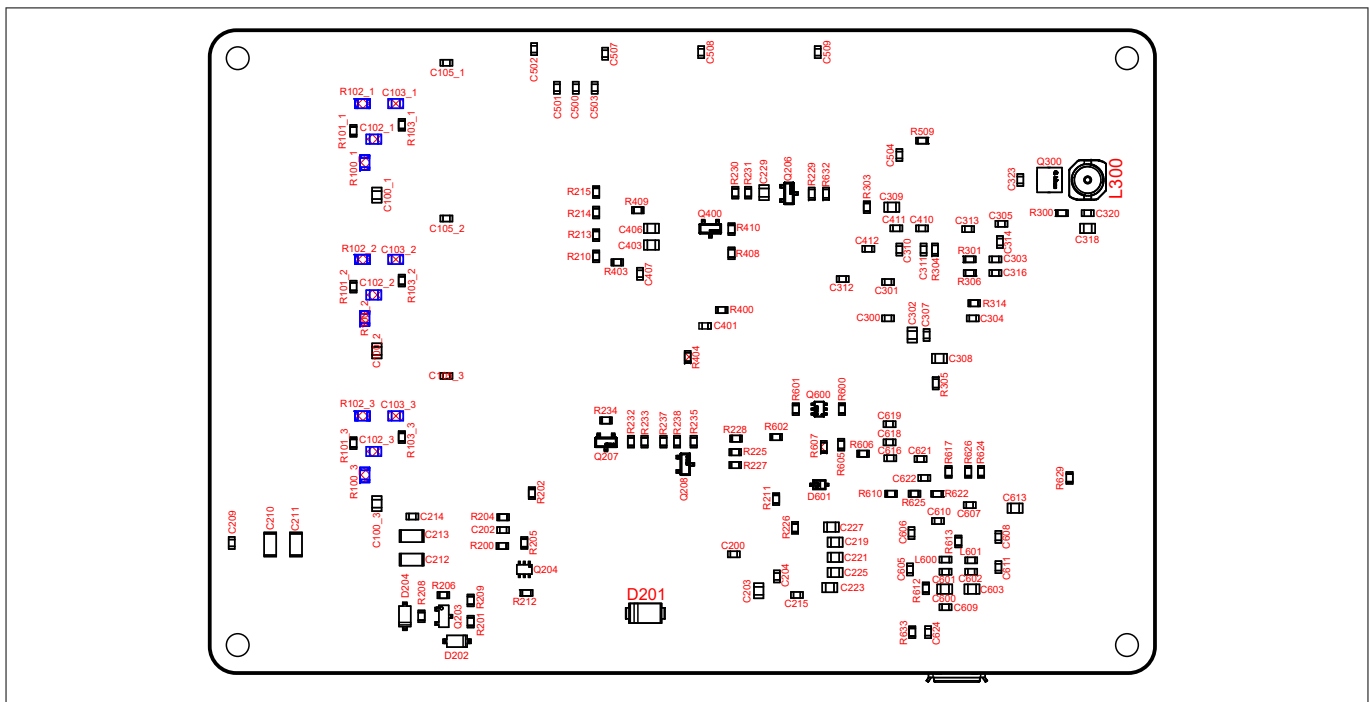

**Figure 8 Placement options for MOSFET half-bridges**

To connect motor phases, use the push-in connectors.

**2.2.2 Current sense amplifier (CSA)**

- To measure the motor currents with the ISP<sub>x</sub> and ISN<sub>x</sub> pins of the device, place three shunt resistors R36\_x on the board between the SL<sub>x</sub> pin of the device and ground of the *DC*-link capacitor
- To filter the shunt signals, use the capacitors places between ISP<sub>x</sub> and ISN<sub>x</sub> (C105\_x), between ISP<sub>x</sub> and ground (C104\_x) and between ISN<sub>x</sub> and ground (C106\_x)

**Note:** *If you apply motor currents exceeding the maximum ratings given in [Technical data](#), you must consider the maximum current ratings of the shunt resistor used.*

2 System and functional description

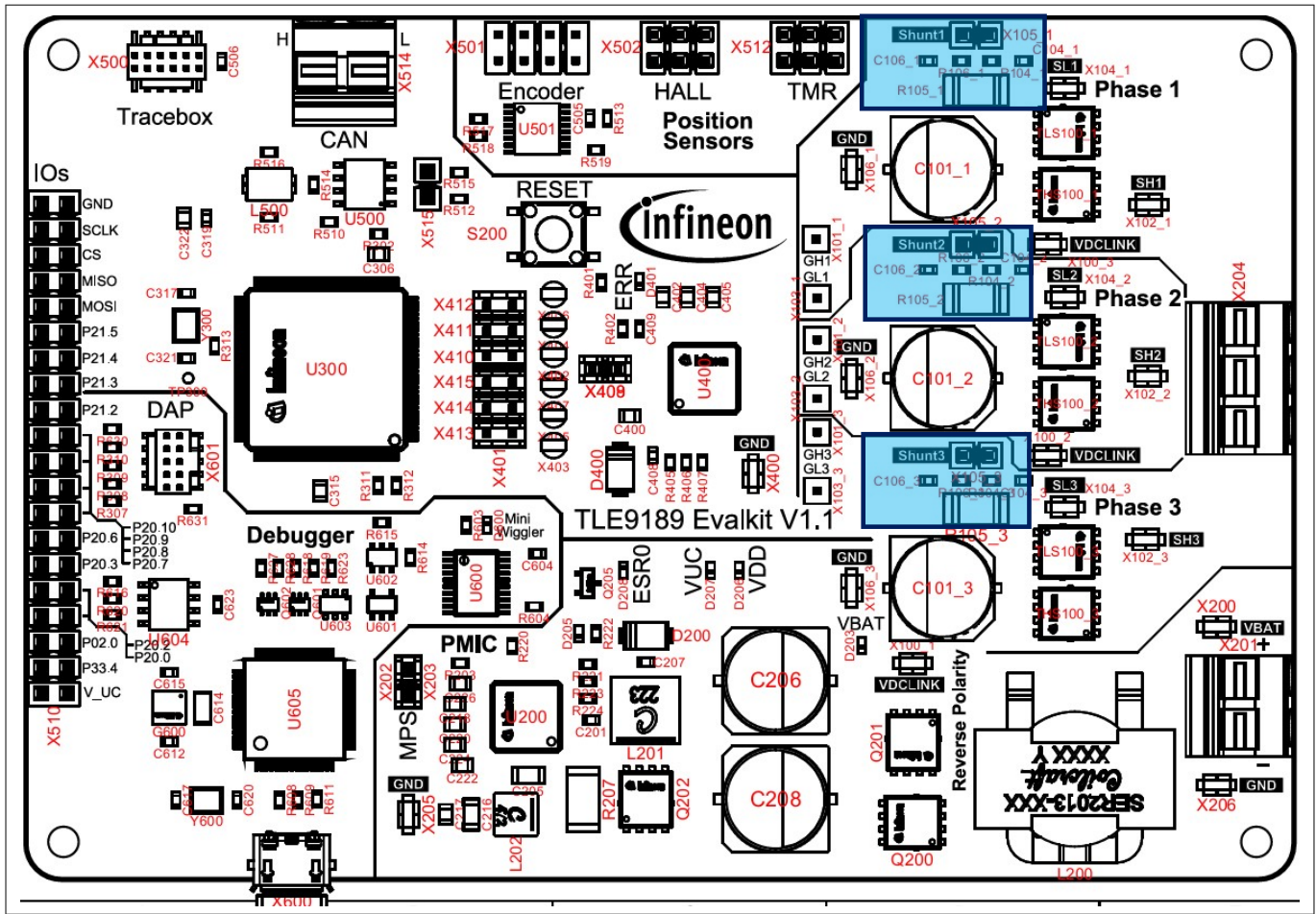

Figure 9 Placement and test points at CSA

2.2.3 Motor position sensors

2.2.3.1 Encoder

An encoder can be connected to the connector X501, which consists of a 8-pin header (2 x 4) with a 2 mm pitch. The differential encoder signals are transferred to single digital signals by the differential line receiver U501. The outputs of U501 are connected to P00.7, P00.8 and P02.8 of the microcontroller. The image below shows the encoder interface.



2 System and functional description

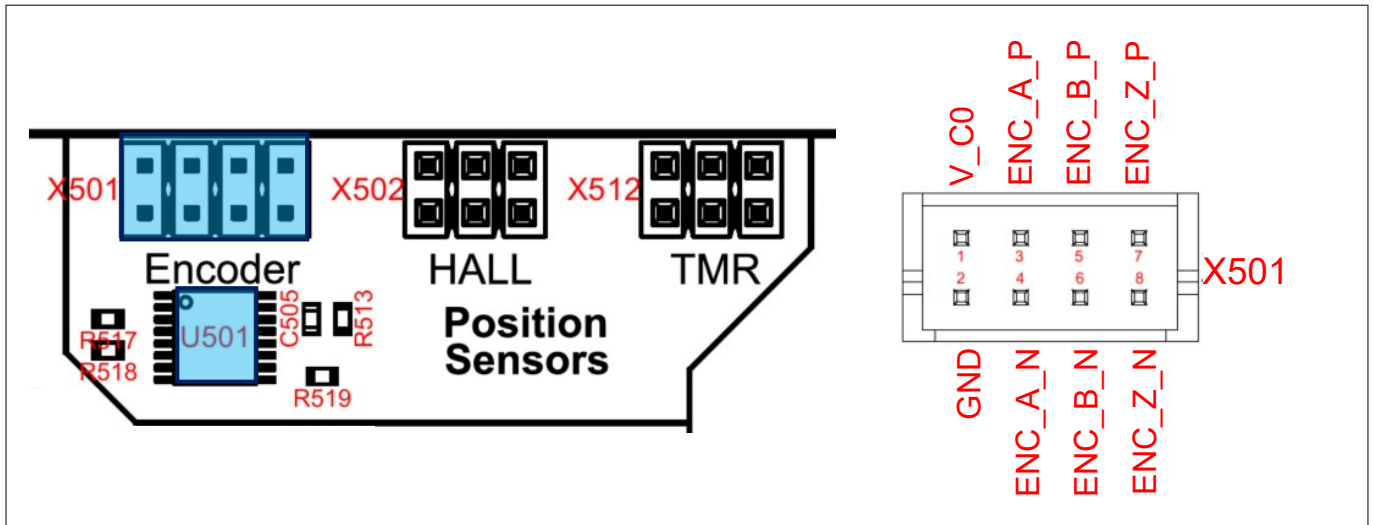

Figure 10 Encoder

2.2.3.2 Hall sensor

A hall sensor can be connected to connector X502, which consists of a 6-pin header (2 x 3) with a 2 mm pitch. The hall signals are connected to P40.0, P40.1 and P40.4 of the microcontroller. The image below shows the hall interface.

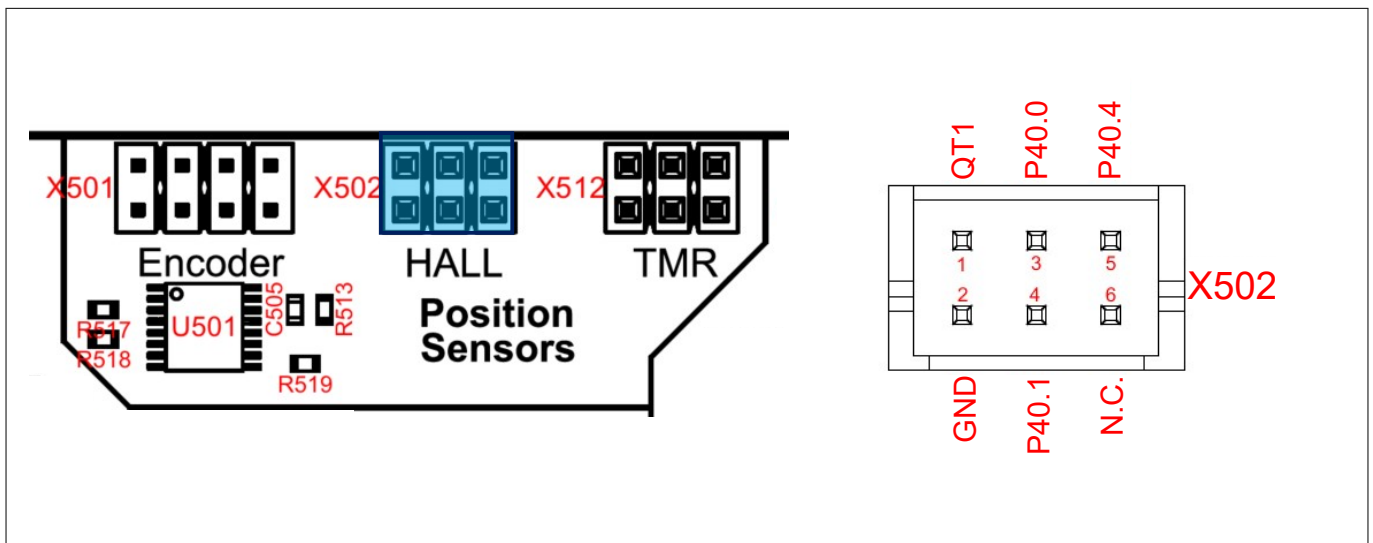

Figure 11 Hall sensor interface

2.2.3.3 Tunneling magnetoresistance sensor

A *tunnel magnetoresistance (TMR)* sensor can be connected to connector X512, which consists of a 6-pin header (2 x 3) with a 2 mm pitch. The analog TMR signals are connected to AN0, AN1, AN38 and AN39 of the microcontroller. The image below shows the TMR interface.

2 System and functional description

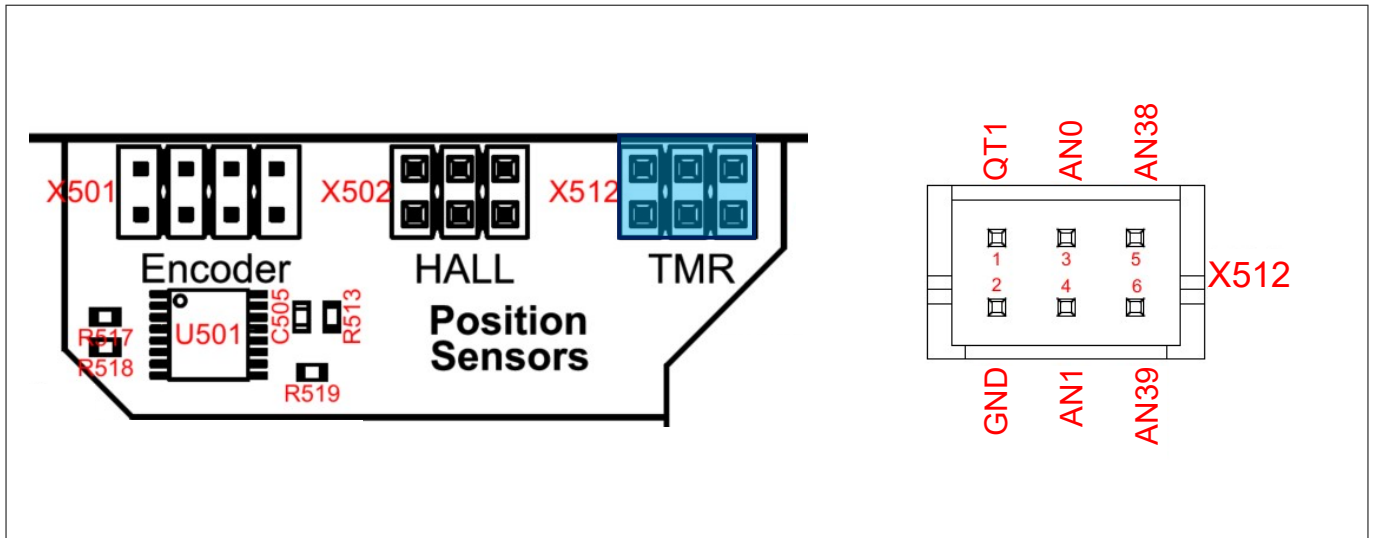

Figure 12 TMR sensor interface

2.2.4 Push button

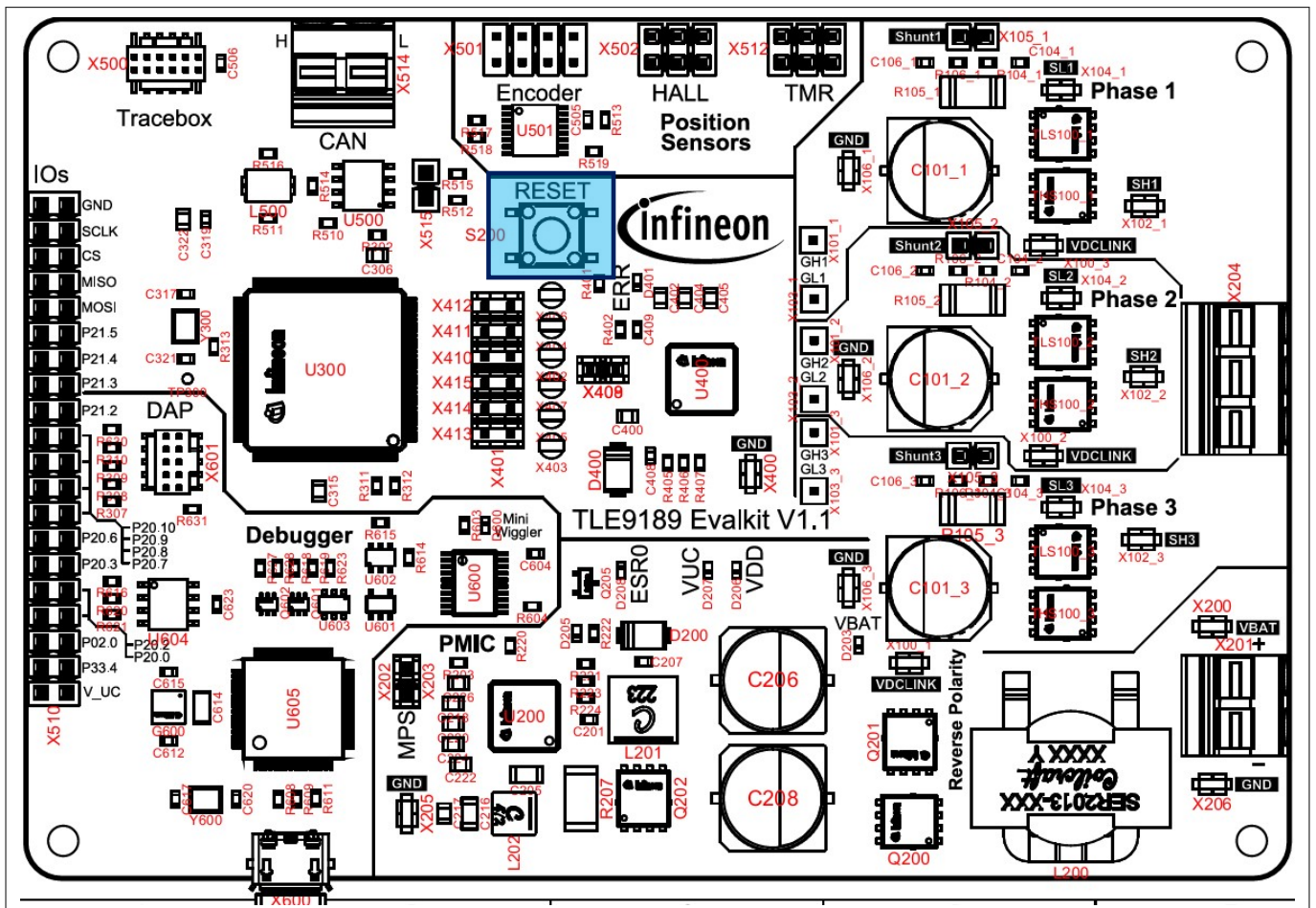

Figure 13 Push button

**2 System and functional description**

**Table 7 Push button**

Push button	Application
RESET	RESET push button pulls down PORST pin to reset the microcontroller

**2.2.5 CAN**

You can connect the CANH and CANL pins of the AURIX™ through the terminal block X56 shown in the figure below.

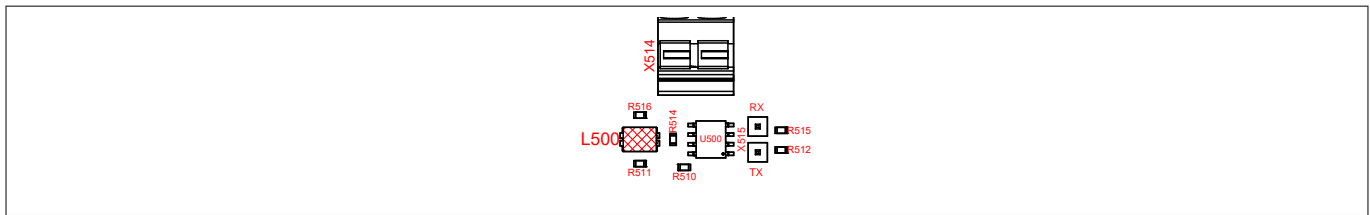

**Figure 14 CANH/CANL terminal block X56**

A high speed **CAN** transceiver connects the CANH and CANL signals, supplied by V\_CO to the TX and RX signals towards the microcontroller. These are connected to pins P11.12 and P11.10 of the microcontroller. Additionally, the TX and RX signals are connected to pin header X515 as shown in the figure below.

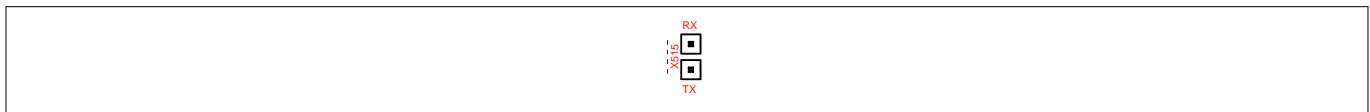

**Figure 15 CAN transceiver and TX/RX signals on X515**

A placement option is available to solder a common mode choke L500. If L500 is placed, the 0 Ω resistors R511 and R516 need to be removed, as shown in the figure below.

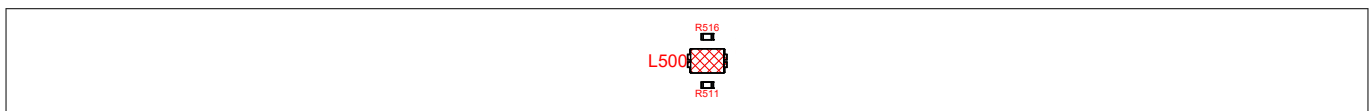

**Figure 16 Placement option for common mode choke**

**2.2.6 Tracebox**

To interface the microcontroller with the Tracebox, use the Tracebox connector X500. For more information about the Tracebox, visit the [Infineon homepage](#).

2 System and functional description

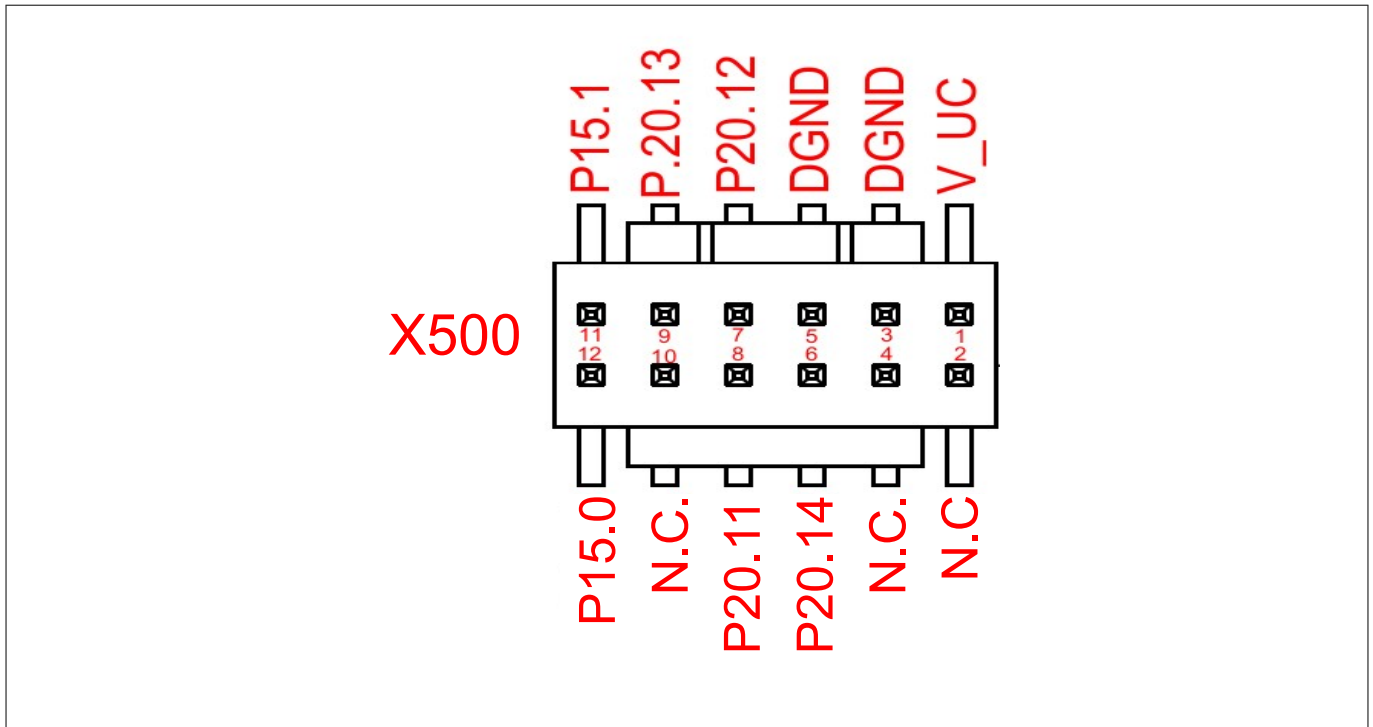

Figure 17 Pinout of Tracebox connector X500

2.2.7 Debug interfaces

A miniWiggler debugger is on the board and can be connected using a [USB](#) cable. It can also be used for UART communication using a USB cable. The miniWiggler circuit and USB connector are shown in [Figure 18](#).

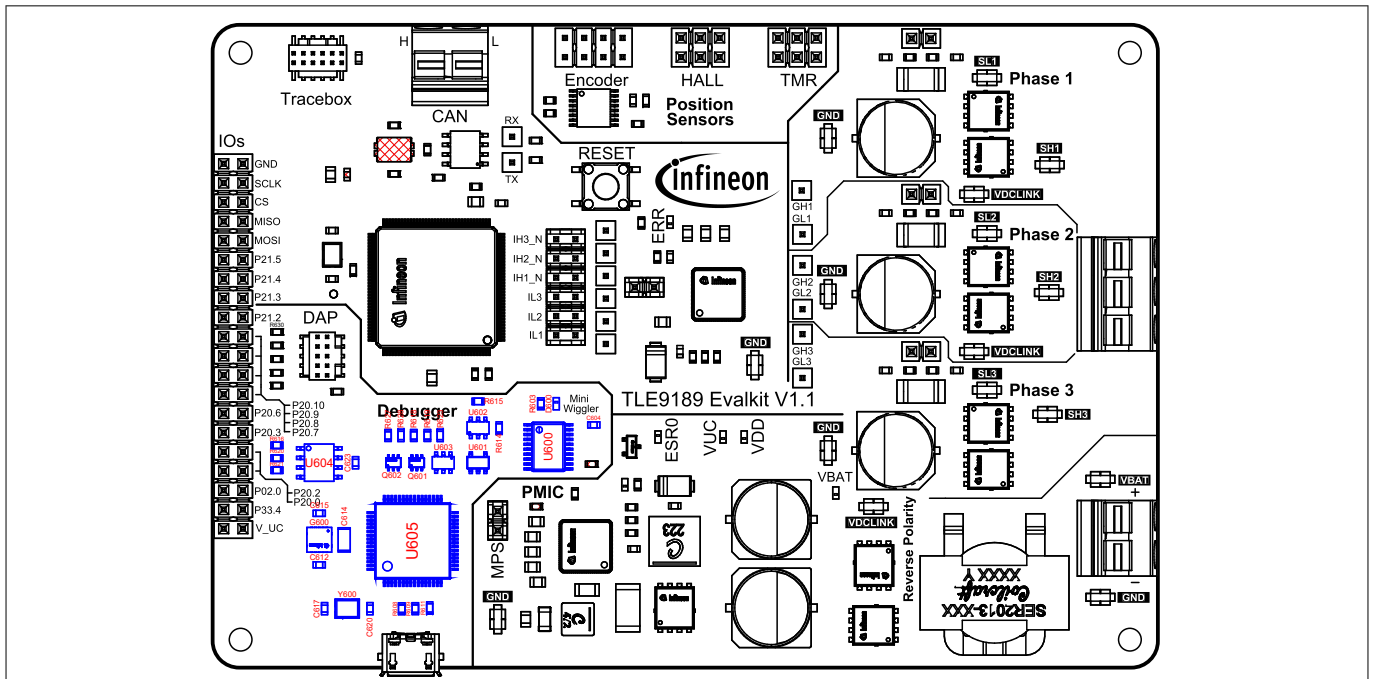

Figure 18 MiniWiggler

In addition to the on-board debugger, there are several other connectors for connecting external debuggers, as shown in [Figure 19](#).

2 System and functional description

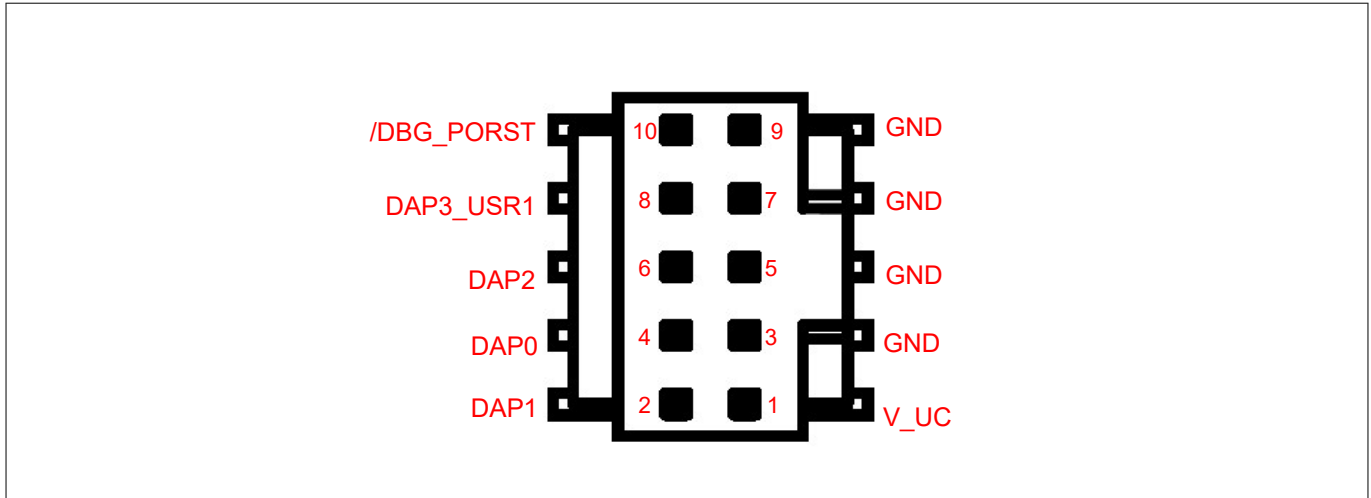

Figure 19 DAP

For more details on the AURIX™ debug interfaces, click [this link](#).

2.2.8 GPIO

Pin header X510 is available to access a set of microcontroller *GPIOs* for general use. The left and right pins are always connected to the same signal. The first row is connected to DGND and the last row is connected to the microcontroller supply voltage V\_UC.

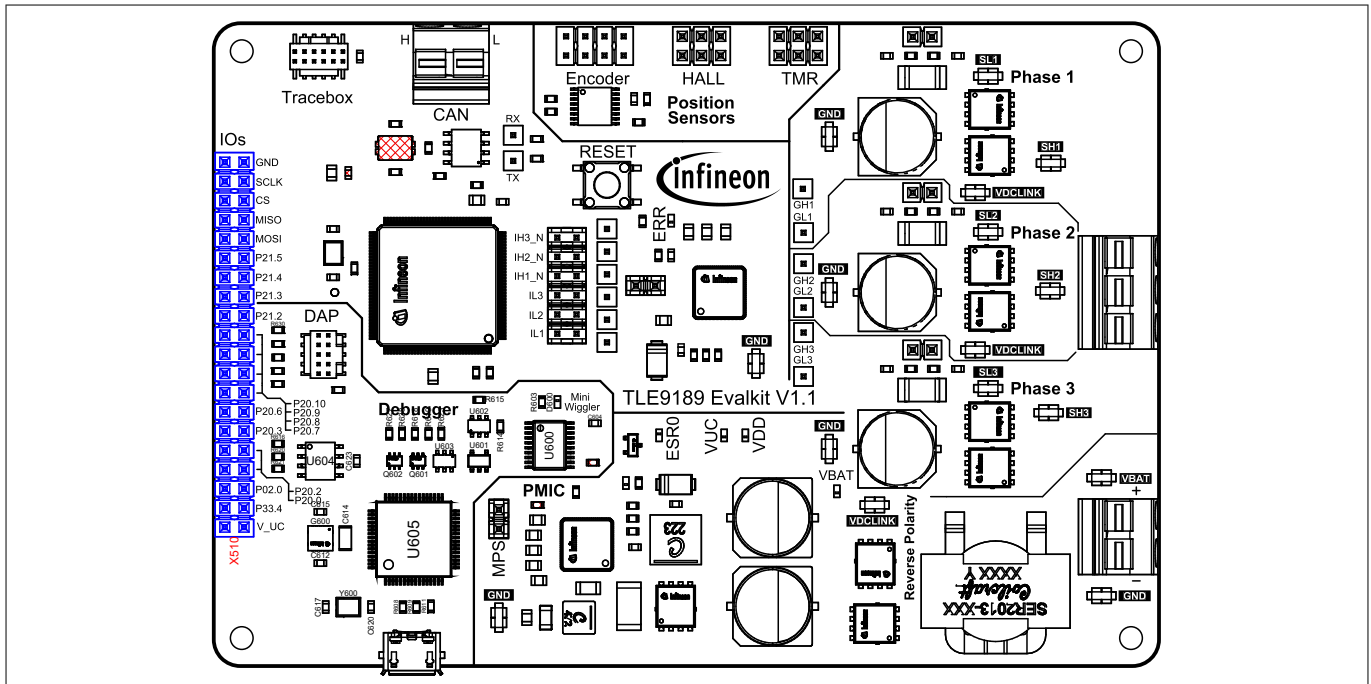

Figure 20 GPIO X510

3 Assembly view

3 Assembly view

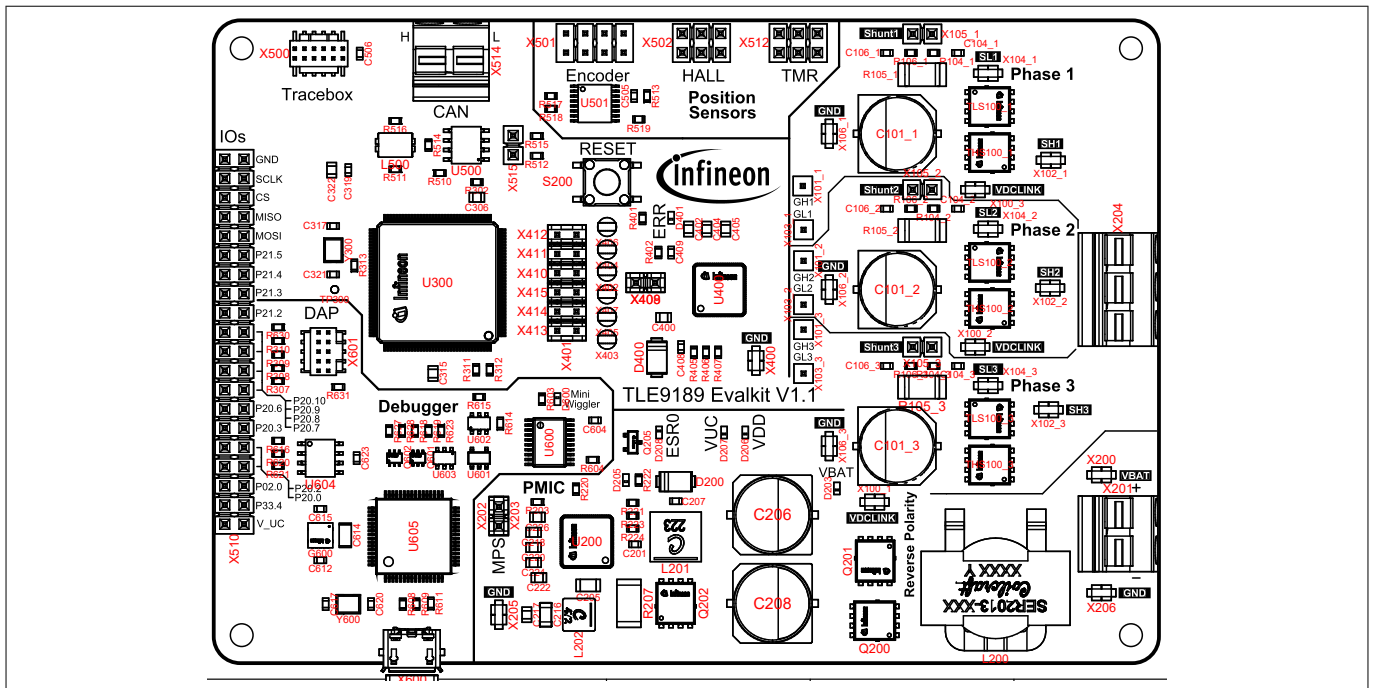

Figure 21 TLE9189 evaluation kit - top view

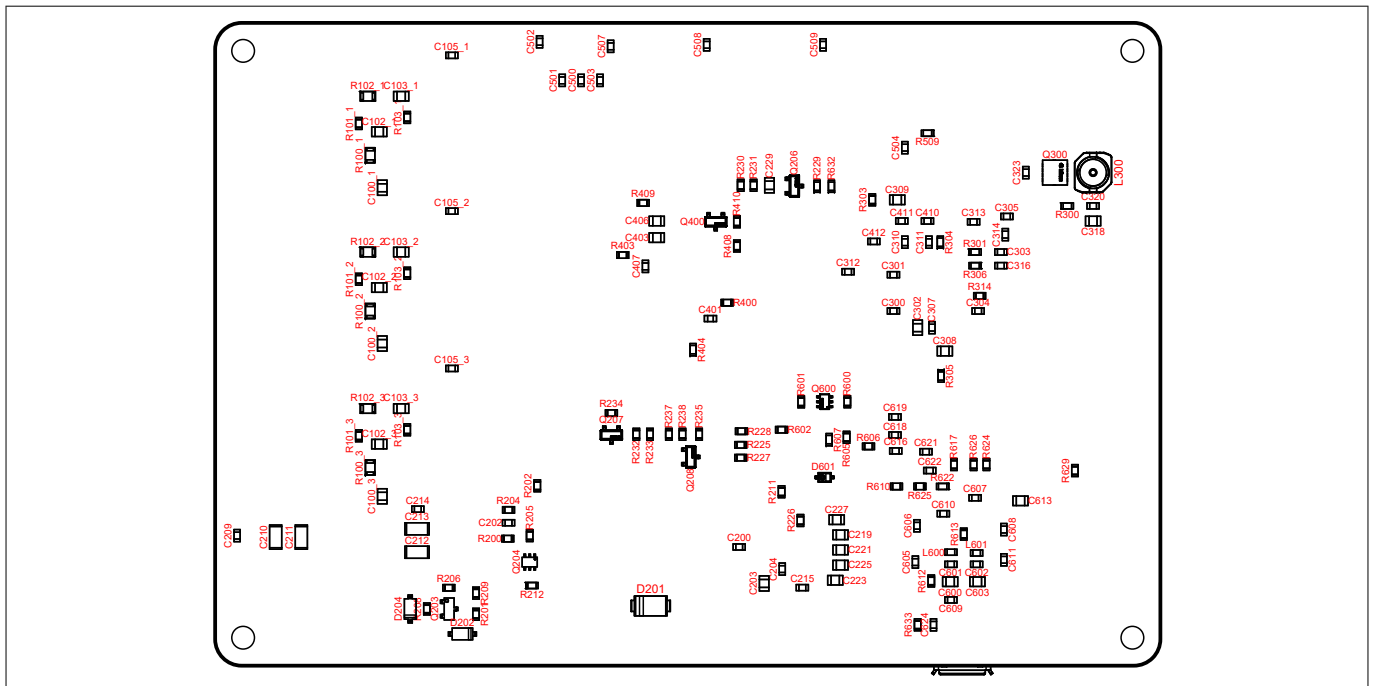

Figure 22 TLE9189 evaluation kit - bottom view



#### 4 Assembly options

**Table 8**                    **Assembly options**

<b>Component</b>	<b>Description</b>
R404	0 $\Omega$ resistor to connect the VREF pin of the TLE9189 to V_VR reference voltage of PMIC. Place this resistor if you want to use VREF as an input to TLE9189 device. VREF is always connected to AURIX™.
R100_1	Snubber resistor placement option for high-side 1
R100_2	Snubber resistor placement option for high-side 2
R100_3	Snubber resistor placement option for high-side 3
R102_1	Snubber resistor placement option for low-side 1
R102_2	Snubber resistor placement option for low-side 2
R102_3	Snubber resistor placement option for low-side 3
C102_1	Snubber capacitance placement option for high-side 1
C102_2	Snubber capacitance placement option for high-side 2
C102_3	Snubber capacitance placement option for high-side 3
C103_1	Snubber capacitance placement option for low-side 1
C103_2	Snubber capacitance placement option for low-side 2
C103_3	Snubber capacitance placement option for low-side 3



5 Software toolchain

## 5 Software toolchain

The Configuration Wizard for MOTIX™ *brushless direct current (BLDC)* Motor Gate Driver ICs allows easy configuration of Automotive Motor Gate Driver IC products.

To install the *graphical user interface (GUI)* from the Infineon development center:

1. Go to [Infineon Developer Center Launcher](#)
2. Follow the instructions provided on the launcher web page
3. Launch the **Infineon Developer Center Launcher** on your computer
4. Select **Manage Tools**
5. Search and install **Config Wizard for MOTIX™ BLDC Motor Gate Driver ICs**
6. After the installation click **Start** on the launch tool

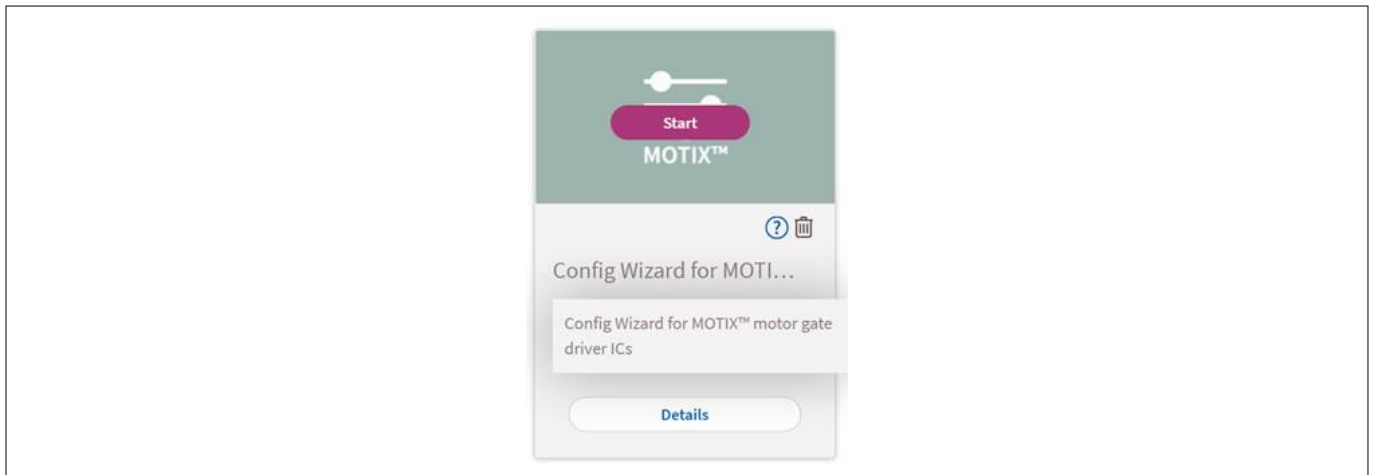

Figure 25 Starting the Config Wizard for MOTIX™ BLDC Motor Gate Driver ICs

7. Click on **TLE9189 EVALBOARD**

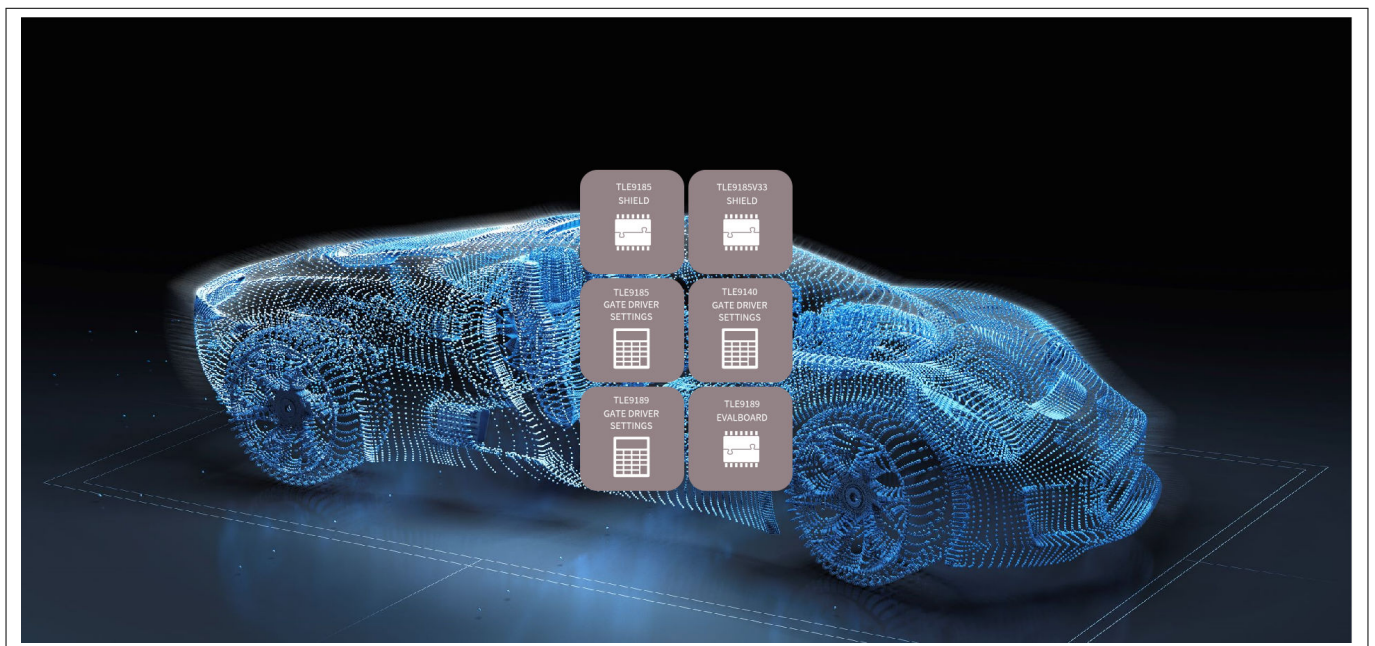

Figure 26 TLE9189 EVALBOARD selection

The tool header bar offers various ways of getting help within the tool. You can access help from any screen in the tool.

6 Design files

6 Design files

The following chapter includes schematics and layouts of the MOTIX™ driver TLE9189 evaluation kit.

6.1 Schematics of the MOTIX™ TLE9189 motor gate driver IC evaluation kit

The following figures show the schematics of the MOTIX™ TLE9189 motor gate driver IC evaluation kit.

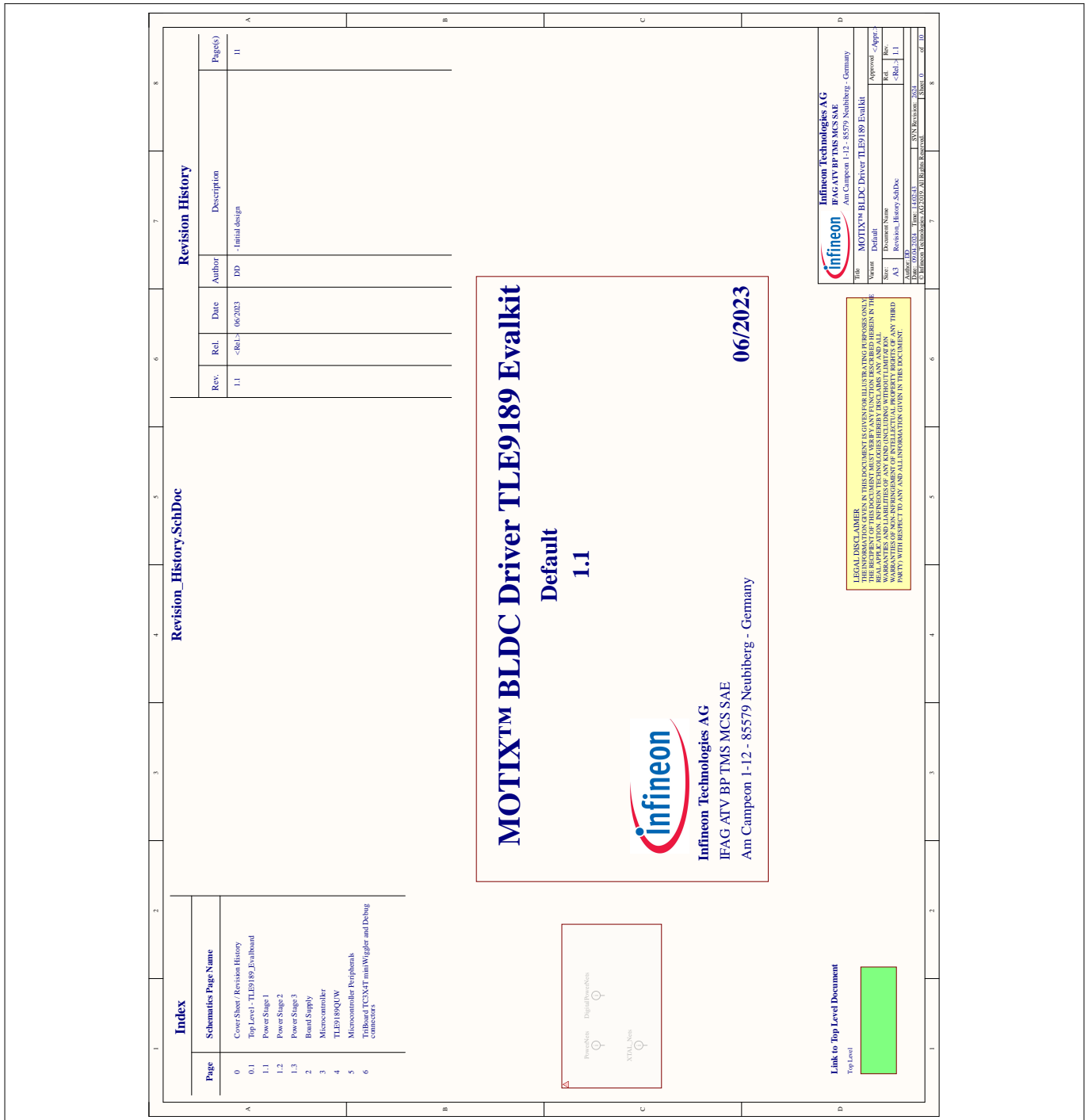
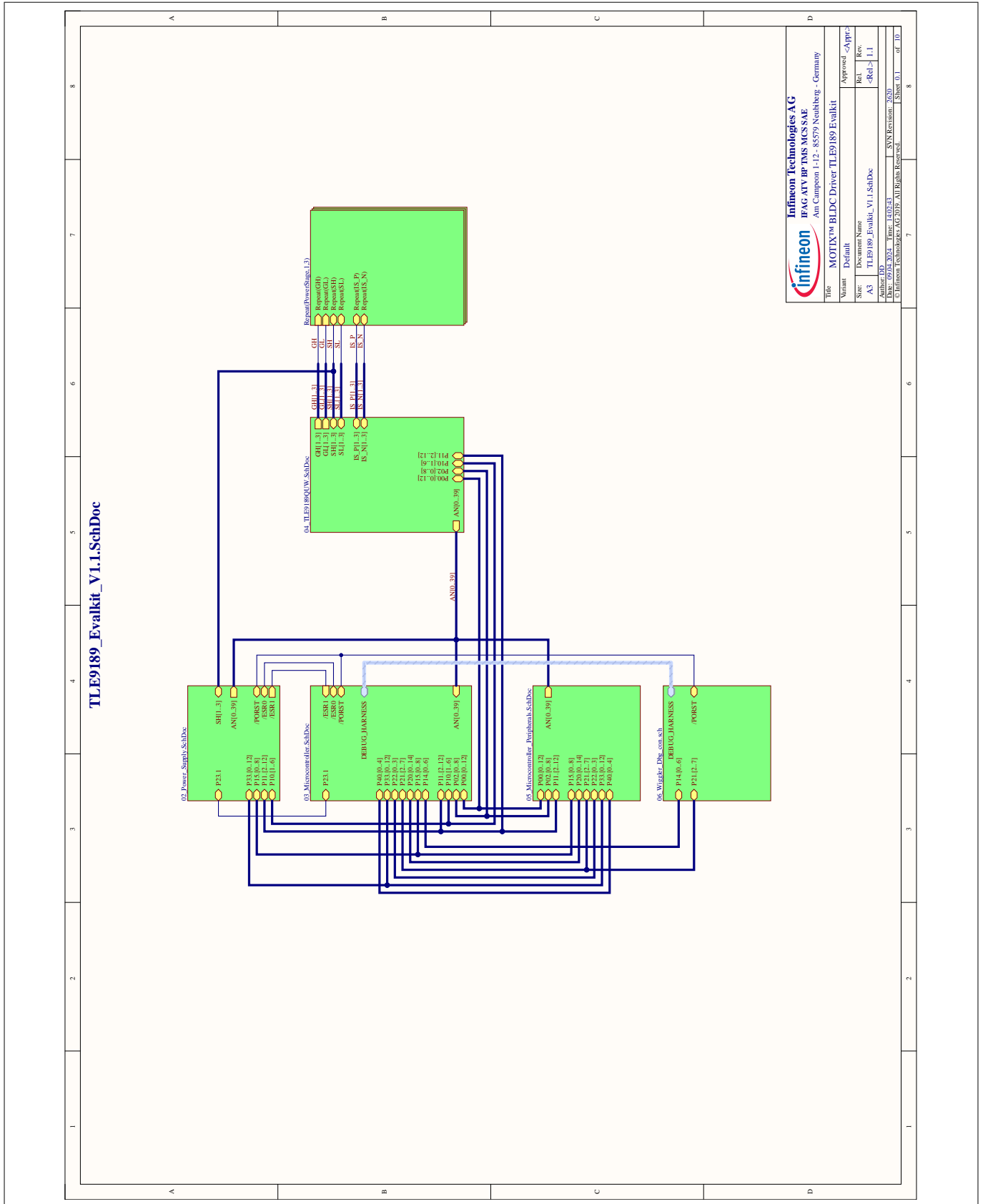

Figure 27 Schematics of the evaluation kit- sheet 1 - cover sheet

6 Design files



		<b>Infineon Technologies AG</b> IFAG ATY BP TMS MCS SAE Am Campeon 1-12 - 85579 Neubiberg - Germany	
Title	MOTIX™ BLDC Driver TLE9189 Evalkit	Approved	<Appr>
Variant	Default	Rel.	Rev.
Size	Document Name	<Rel> 1.1	
Author	ID: 3527 - Name: 1470531	SUN/Revision: 2/25	
© Infineon Technologies AG 2019. All Rights Reserved.		Sheet	01 of 10

Figure 28 Schematics of the evaluation kit- sheet 2 - top level TLE9189 evaluation kit

### 6 Design files

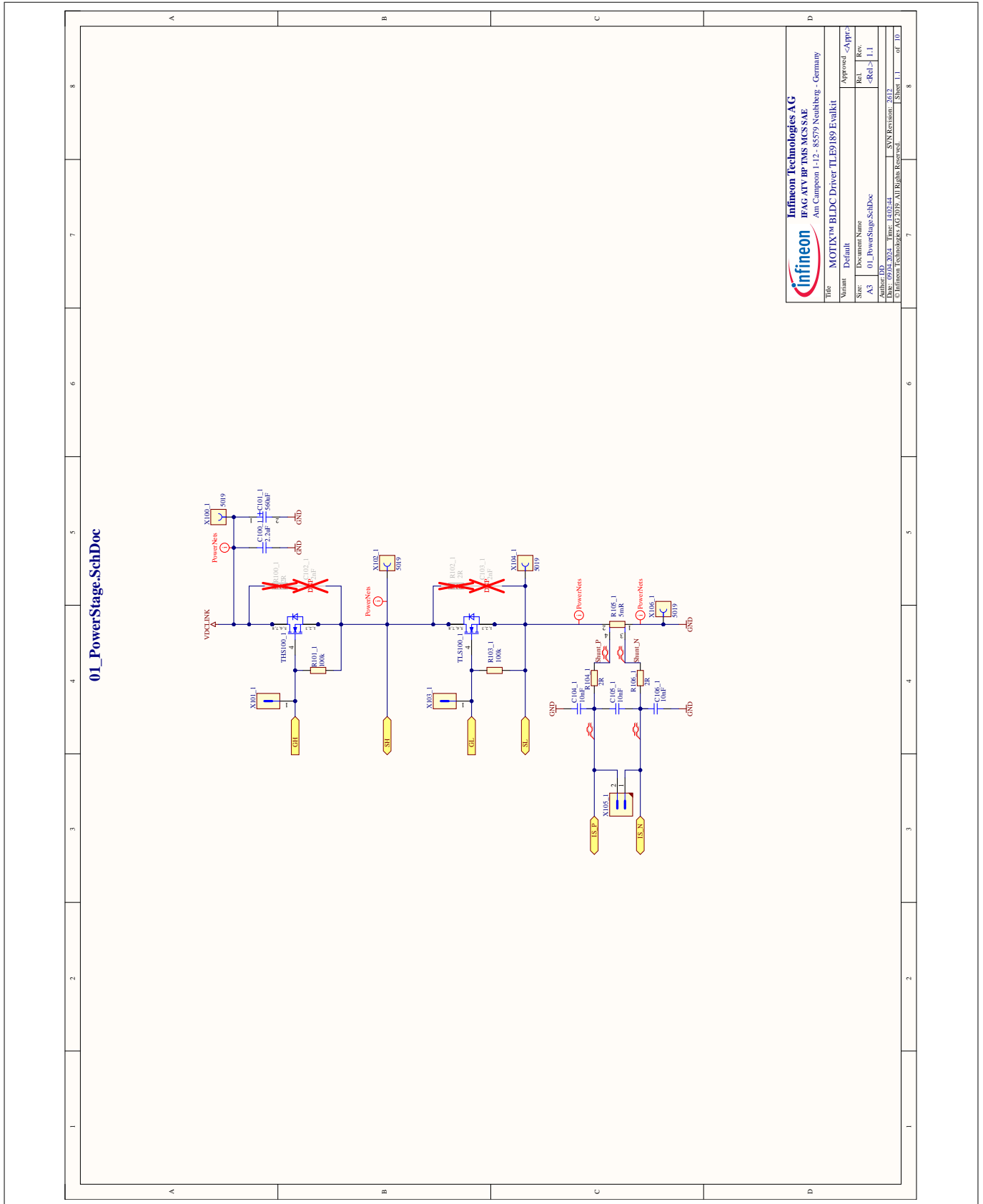

**Figure 29** Schematics of the evaluation kit - sheet 3.1 - power stage 1

6 Design files

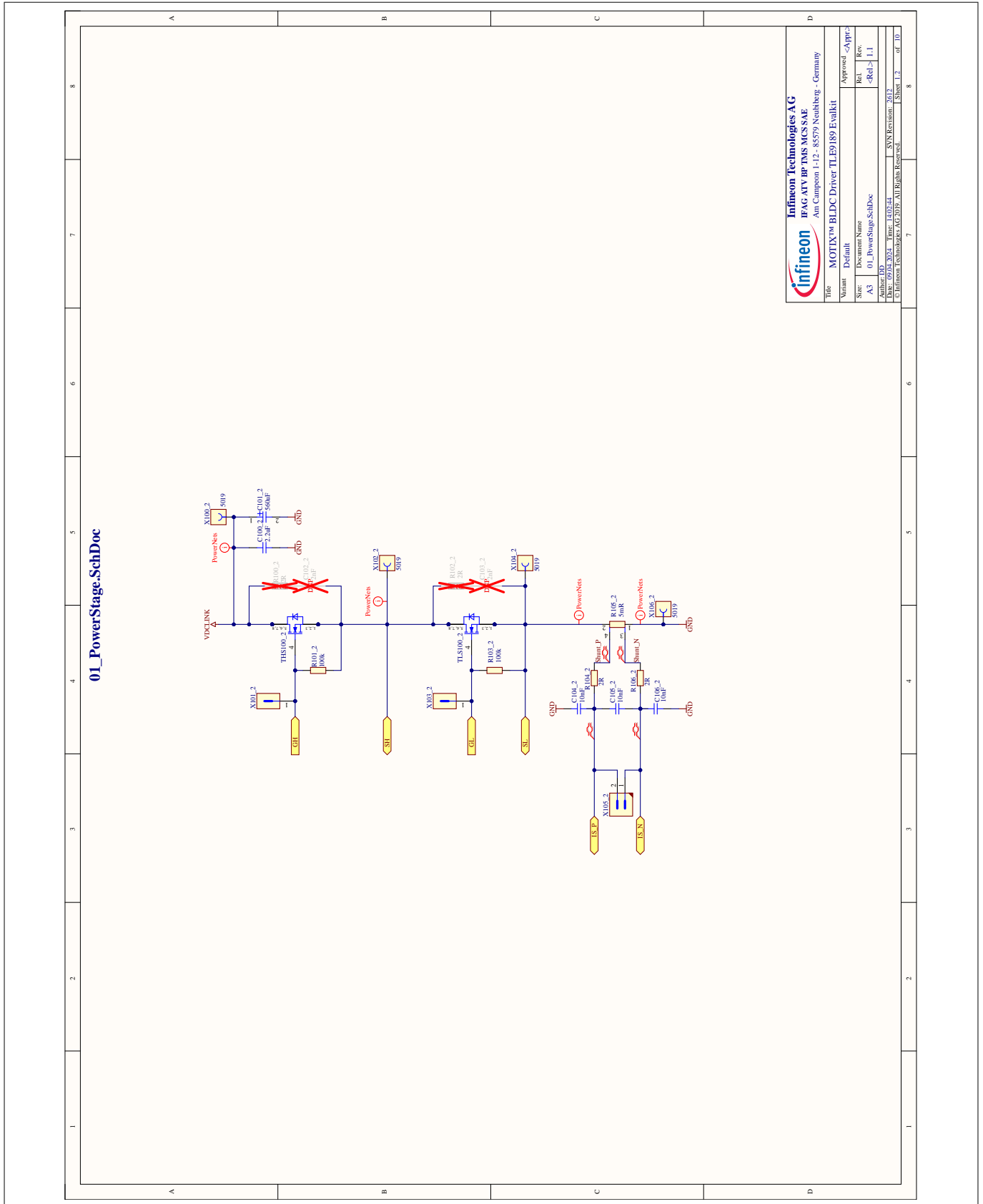

		<b>Infineon Technologies AG</b> IFAG ATY BP TMS MCS SAE Am Campeon 1-12 - 85579 Neubiberg - Germany	
Title	MOTIX™ BLDC Driver TLE9189 Evalkit	Approved	<Appr>
Variant	Default	Rel.	Rev.
Size	Document Name		
A3	01_PowerStage.SchDoc		
Author: JDS	Issue: 1.0/0.1		
© Infineon Technologies AG 2019. All Rights Reserved.		Sheet 1.2 of 10	

Figure 30 Schematics of the evaluation kit - sheet 3.2 - power stage 2

### 6 Design files

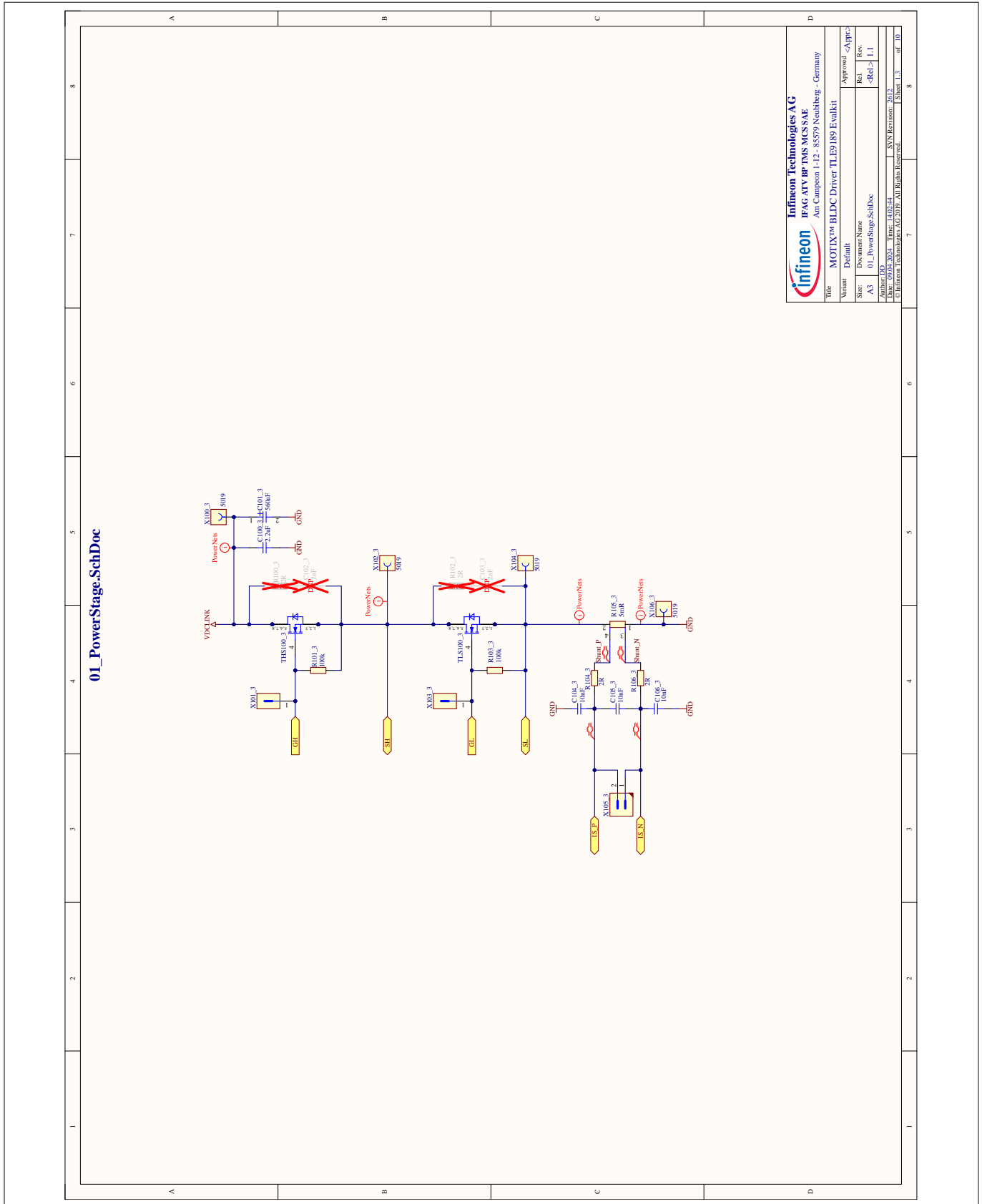

**Figure 31 Schematics of the evaluation kit - sheet 3.3 - power stage 3**

6 Design files

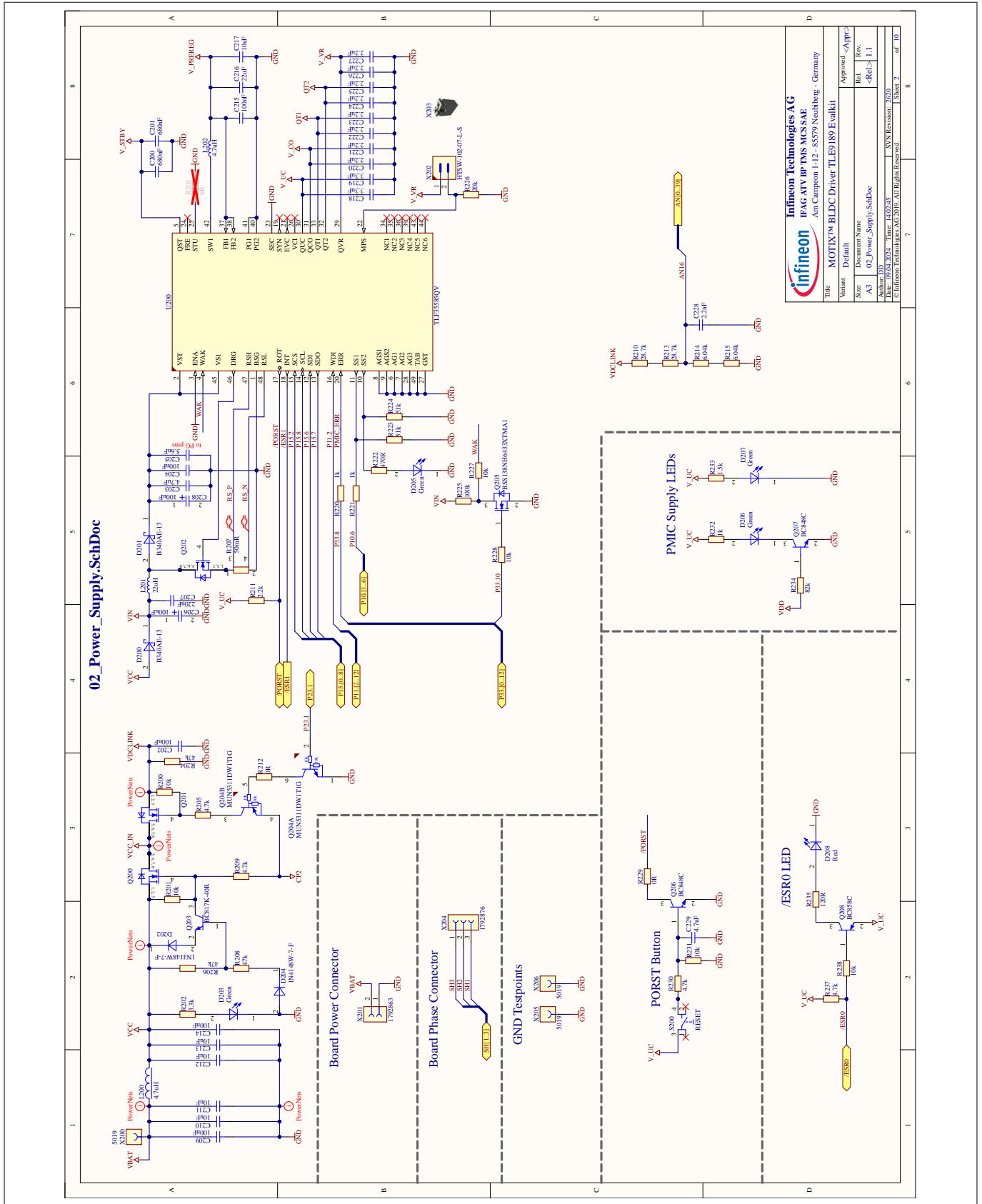

Figure 32 Schematics of the evaluation kit - sheet 4 - board and Aurix™ supply

6 Design files

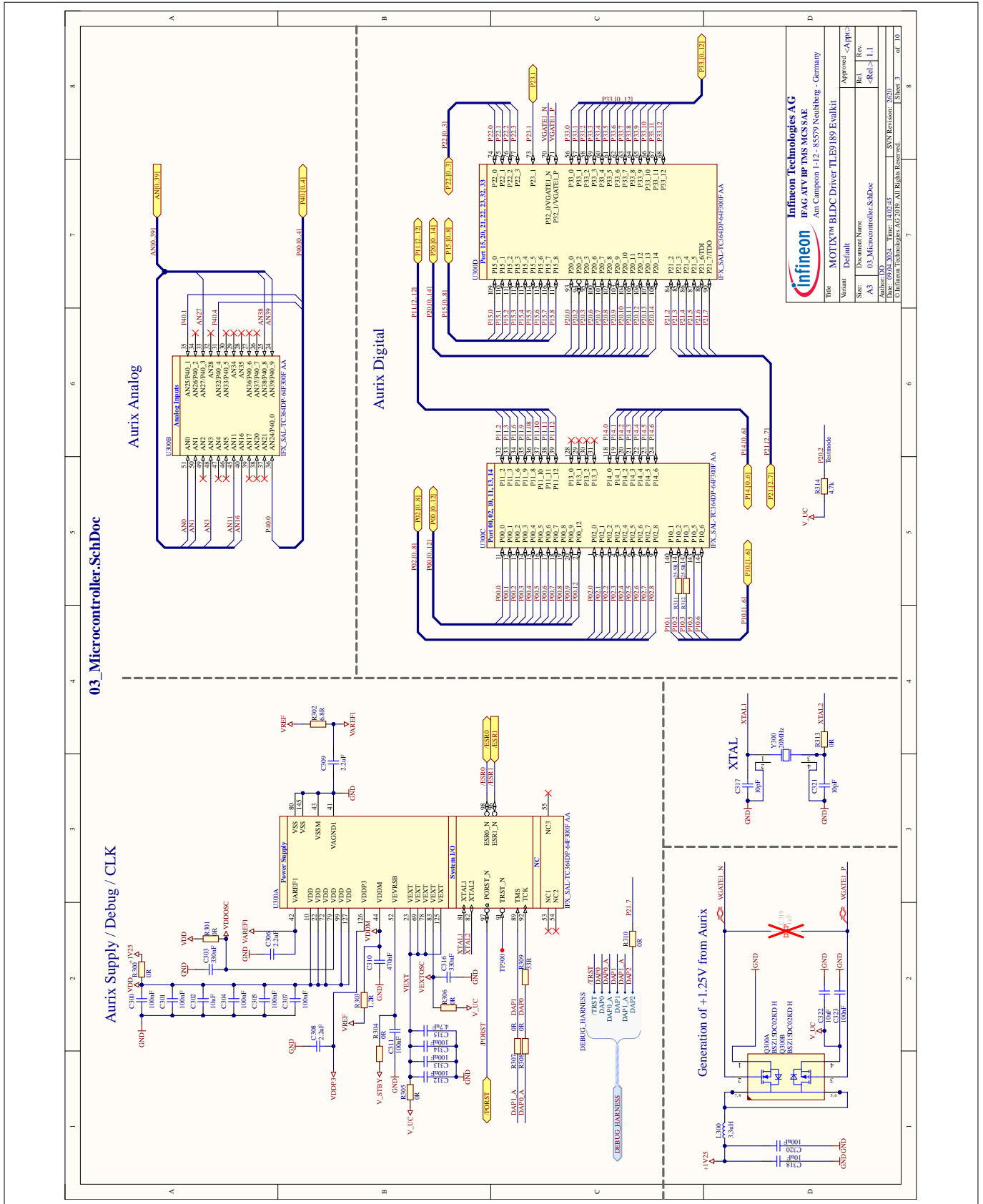

Figure 33 Schematics of the evaluation kit - sheet 5 - microcontroller



6 Design files

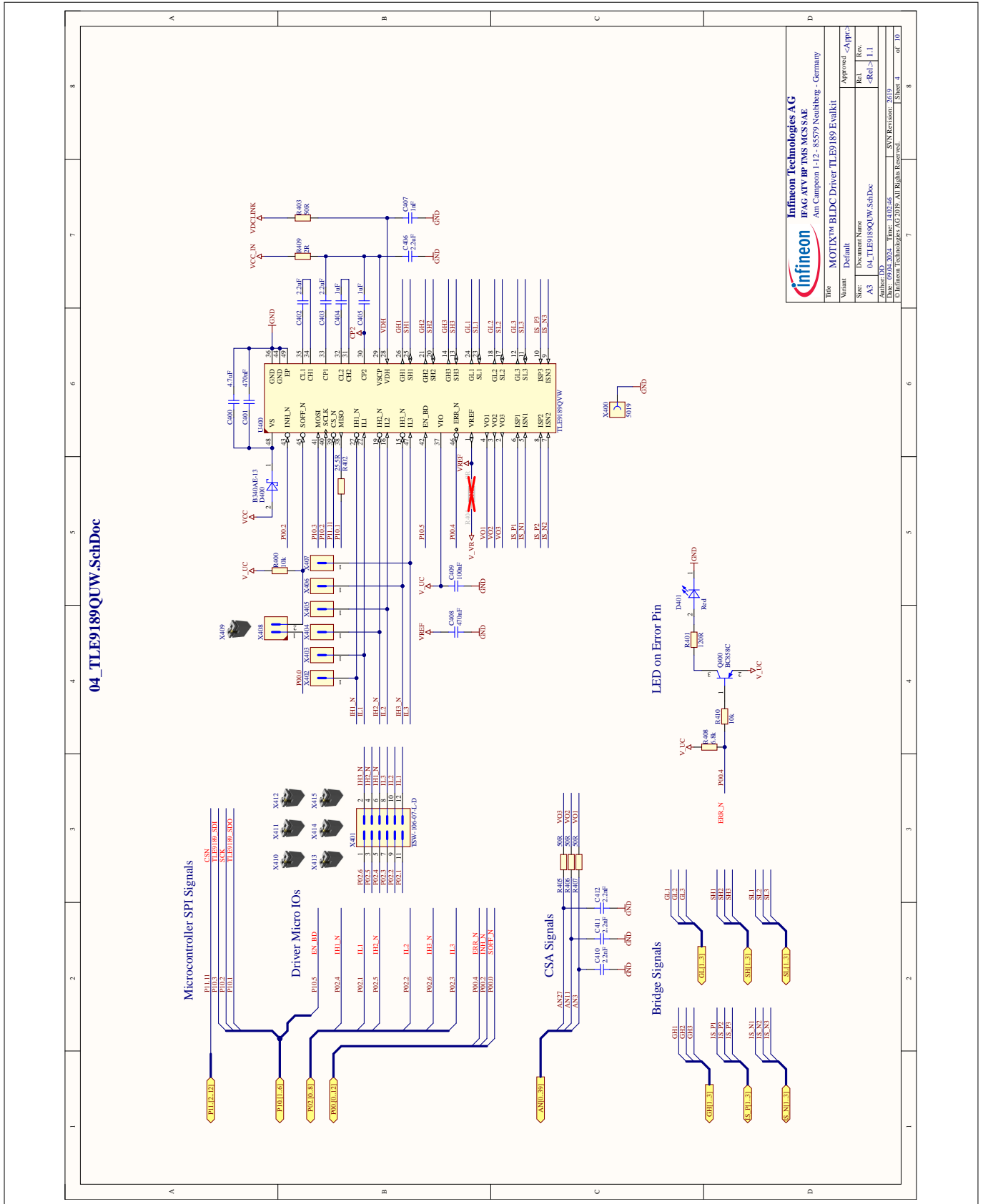

Figure 34 Schematics of the evaluation kit - sheet 6 - TLE9189QUW

6 Design files

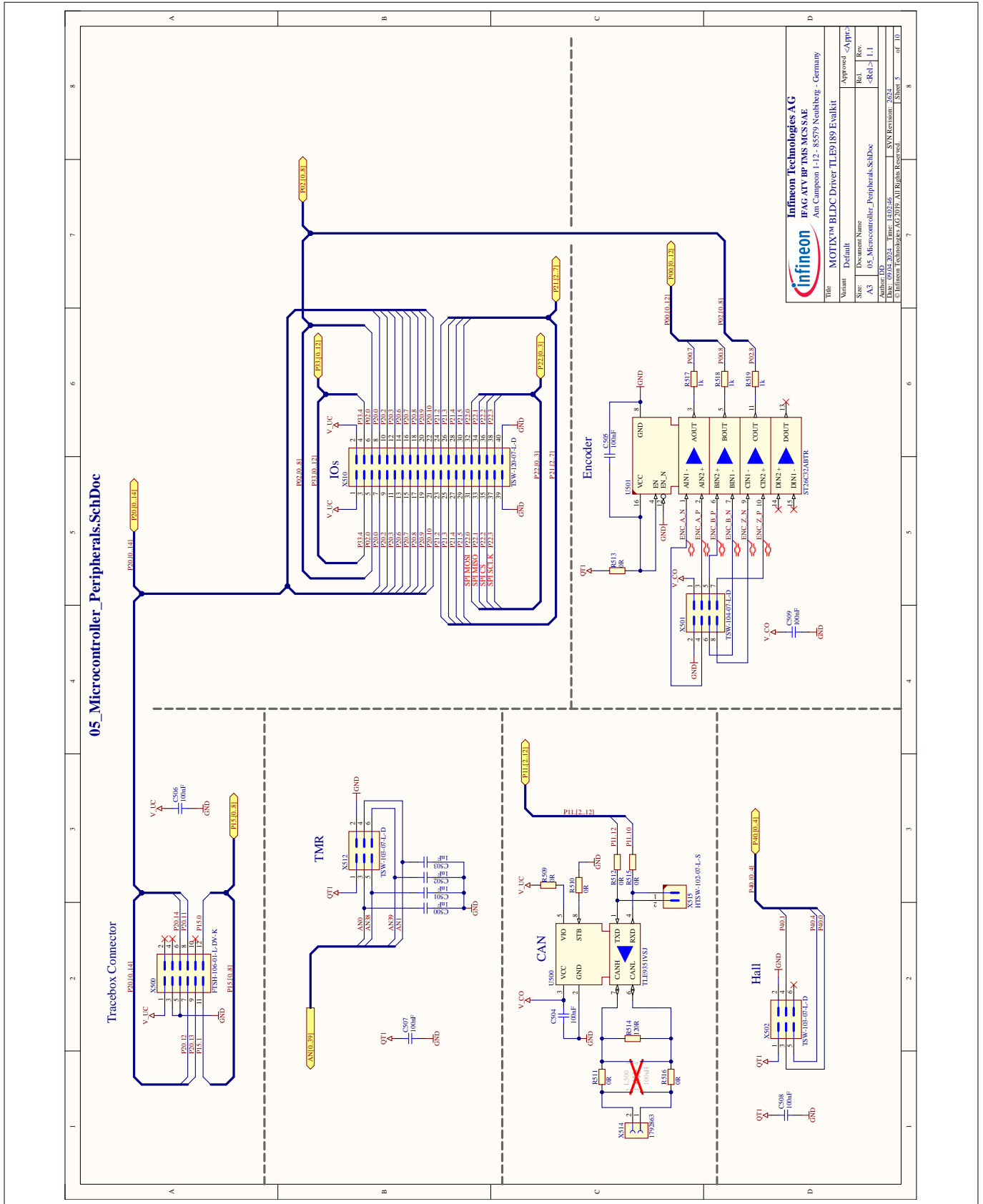
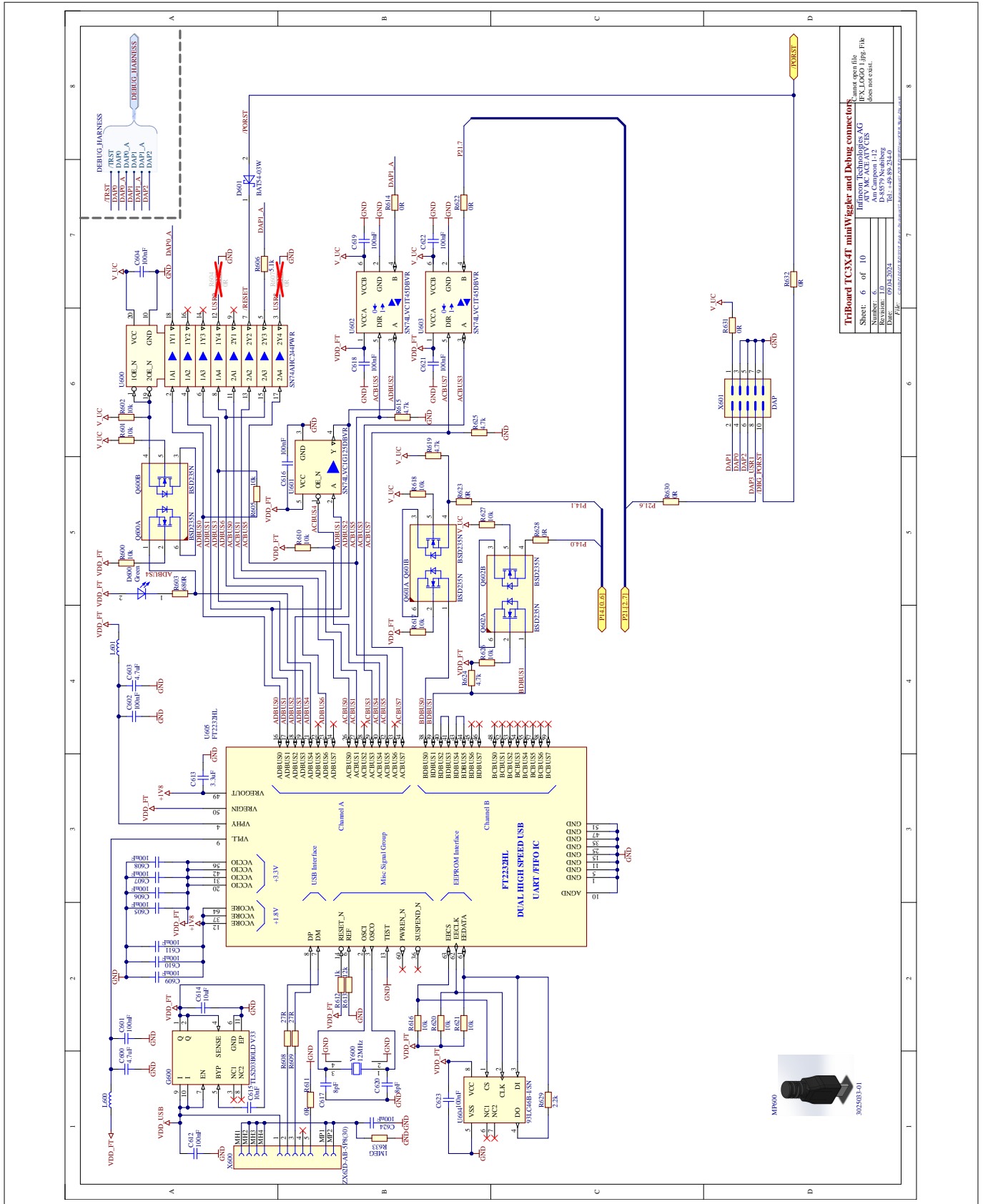

Figure 35 Schematics of the evaluation kit - sheet 7 - microcontroller peripherals

6 Design files



TriBoard TC3X4T miniWiggler and Debug connectors	
Sheet:	6 of 10
Number:	6
Revision:	1.0
Date:	19/02/2024
File:	3025033-01

Infineon Technologies AG  
Am Campeon 112  
D-85579 Neuburg  
Tel.: +49 90 234 0  
Fax: +49 90 234 34 00

Figure 36 Schematics of the evaluation kit - sheet 8 - TriBoard TC3X4T miniWiggler and debug connectors

6 Design files

6.2 Layout of the MOTIX™ TLE9189 motor gate driver IC evaluation kit

The following figures show the layout of the MOTIX™ TLE9189 motor gate driver IC evaluation kit, which consists of six layers.

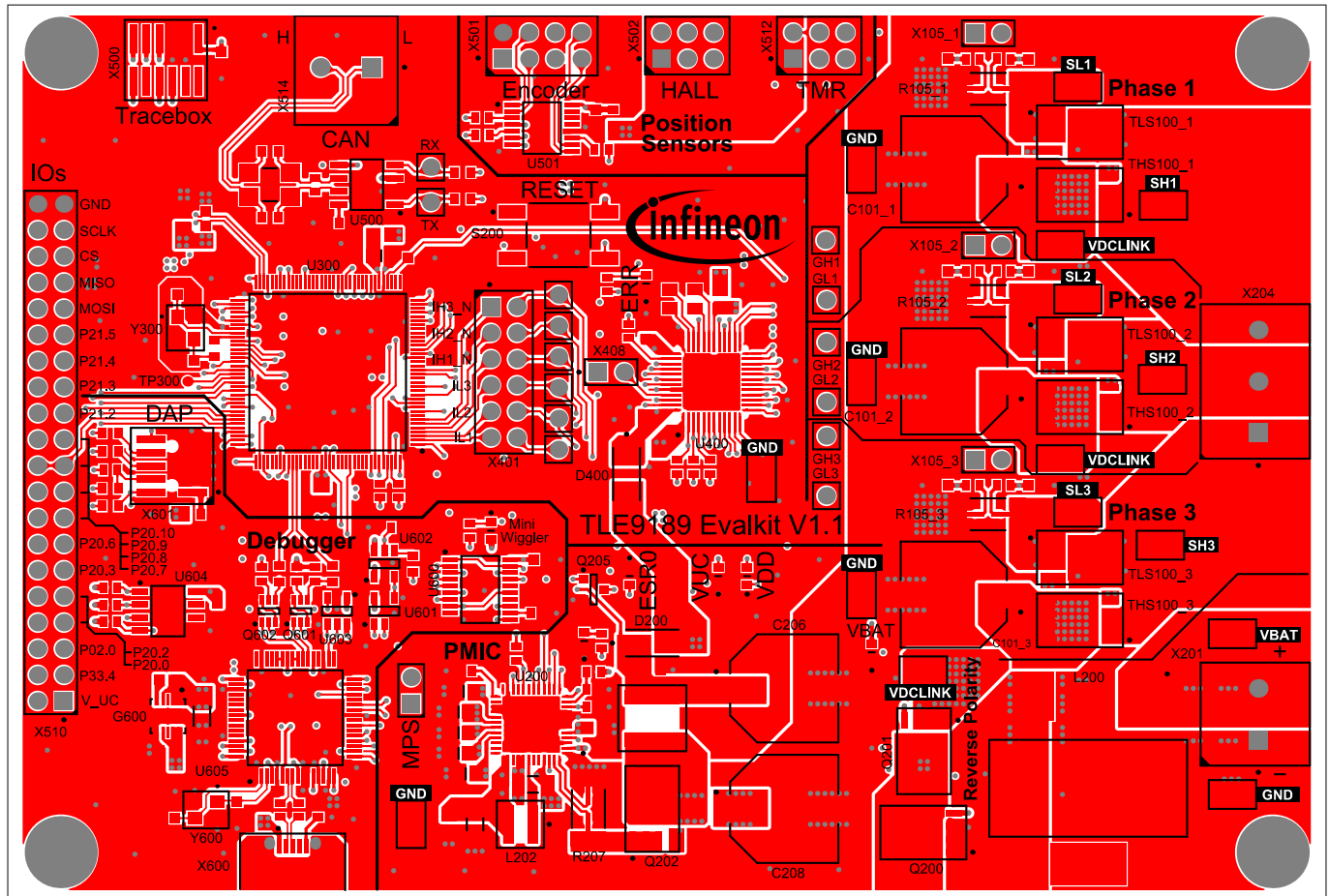

Figure 37 Layout of the evaluation kit - layer 1 - top, signal and power

6 Design files

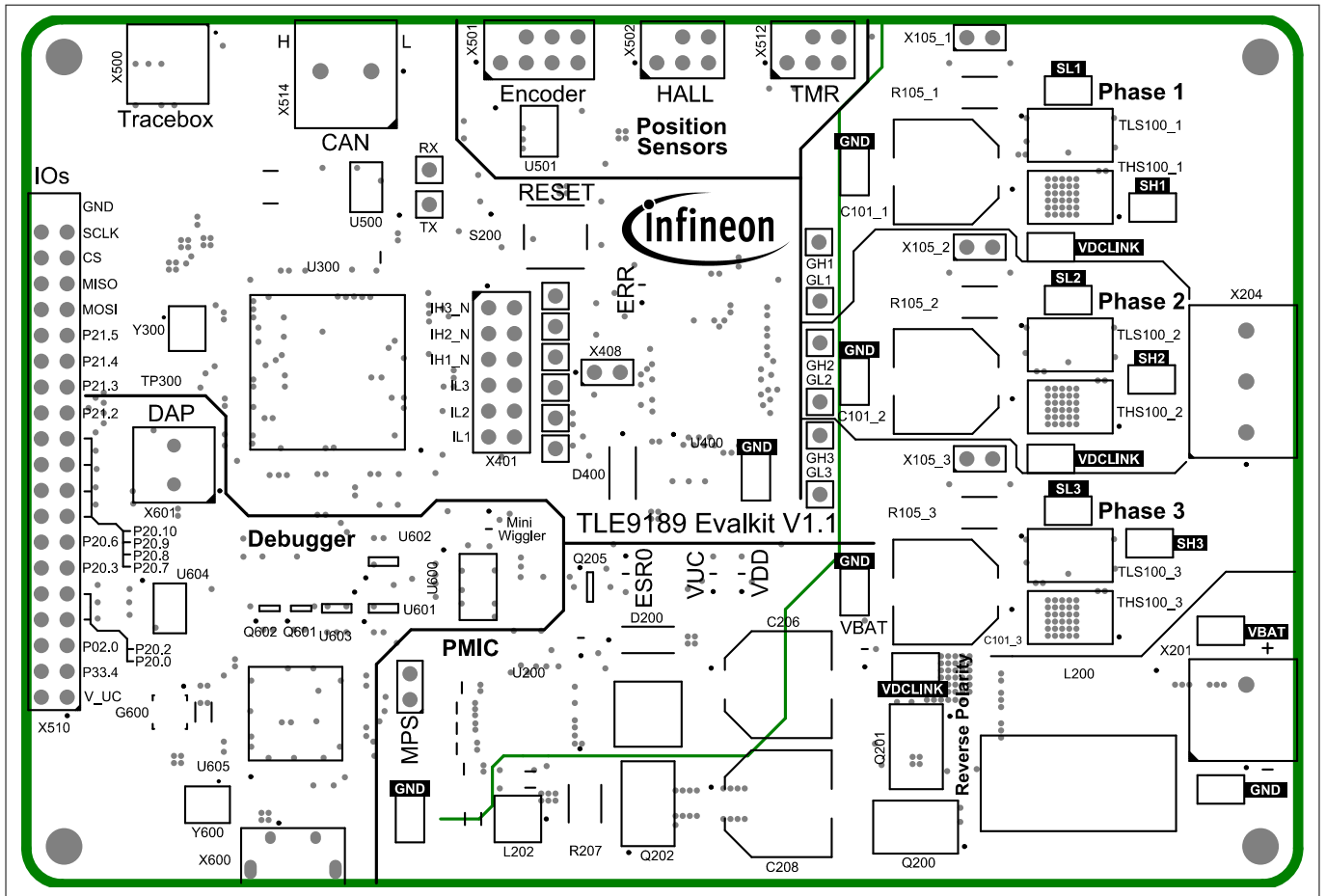

Figure 38 Layout of the evaluation kit- layer 2 - GND

6 Design files

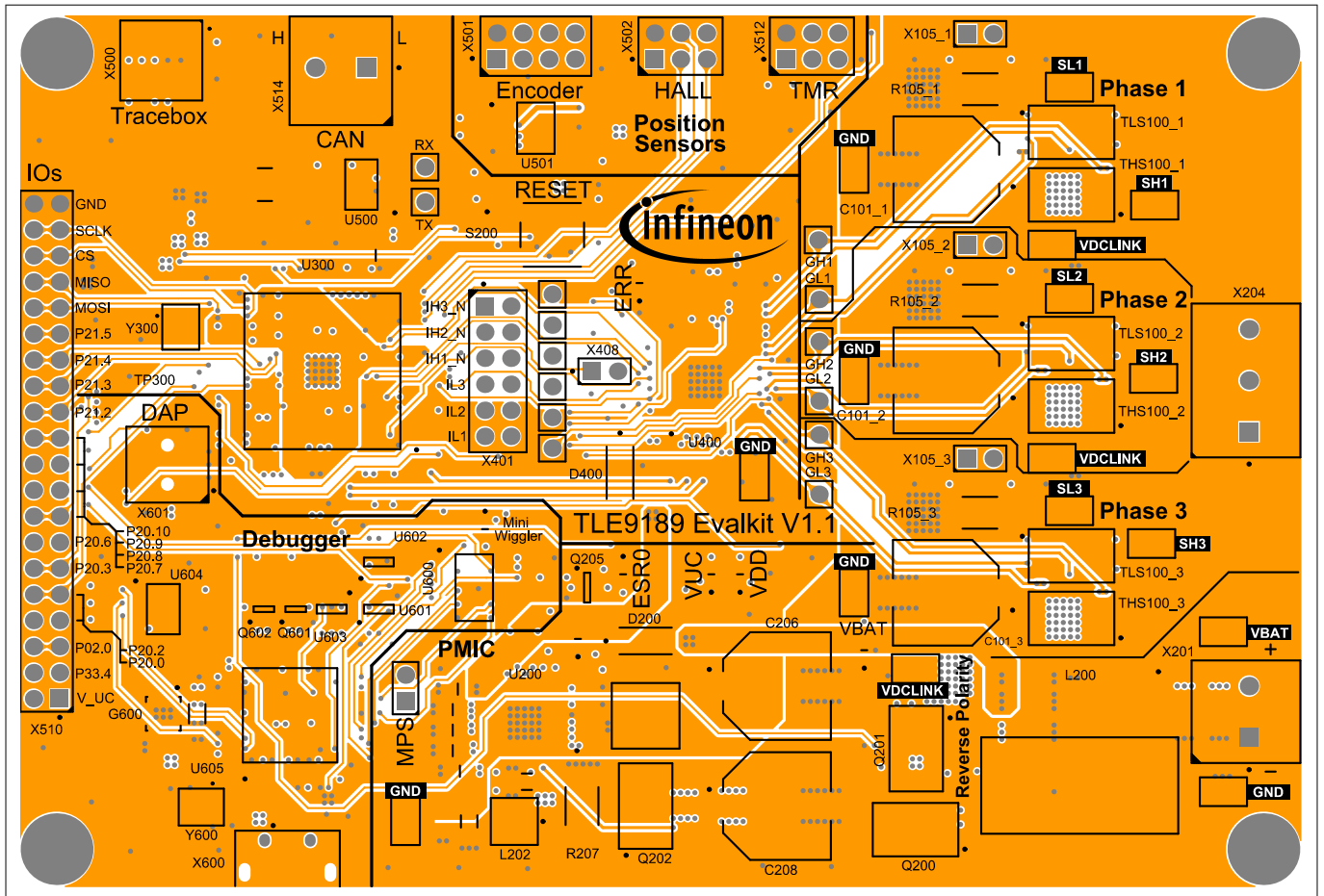

Figure 39 Layout of the evaluation kit - layer 3 - signal

6 Design files

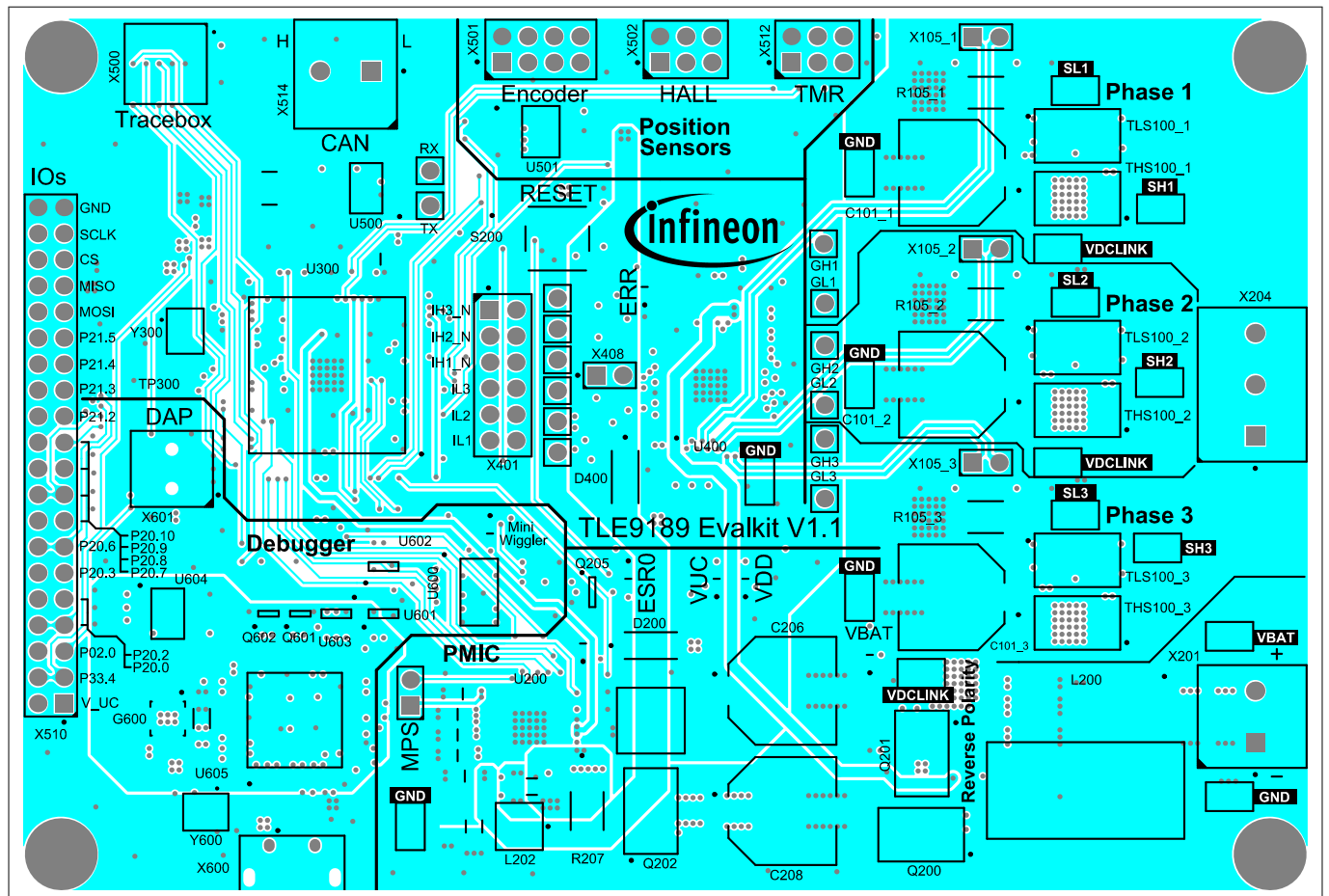
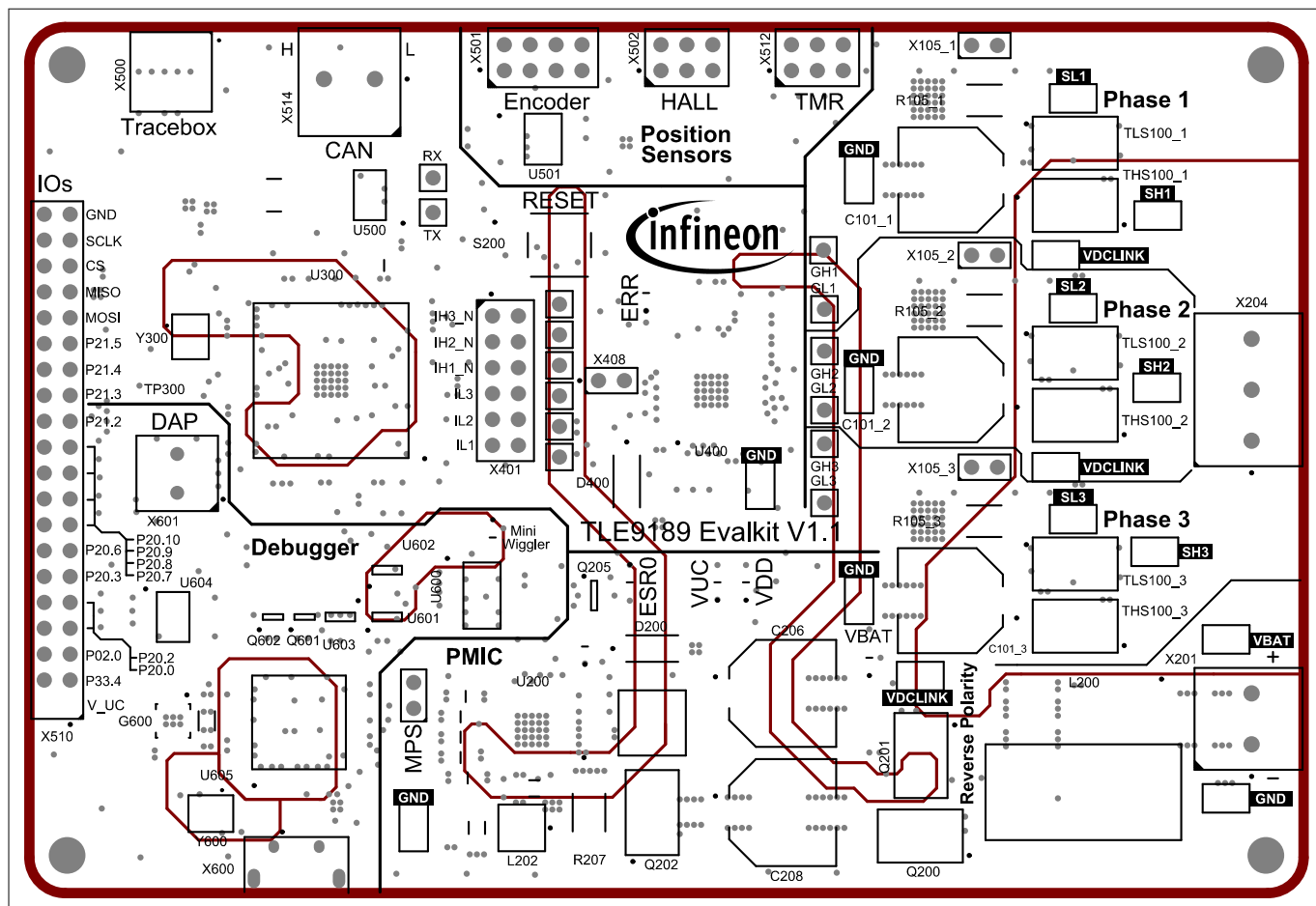

Figure 40 Layout of the evaluation kit- layer 4 - signal

**6 Design files**



**Figure 41**      **Layout of the evaluation kit - layer 5 - power plane**



6 Design files

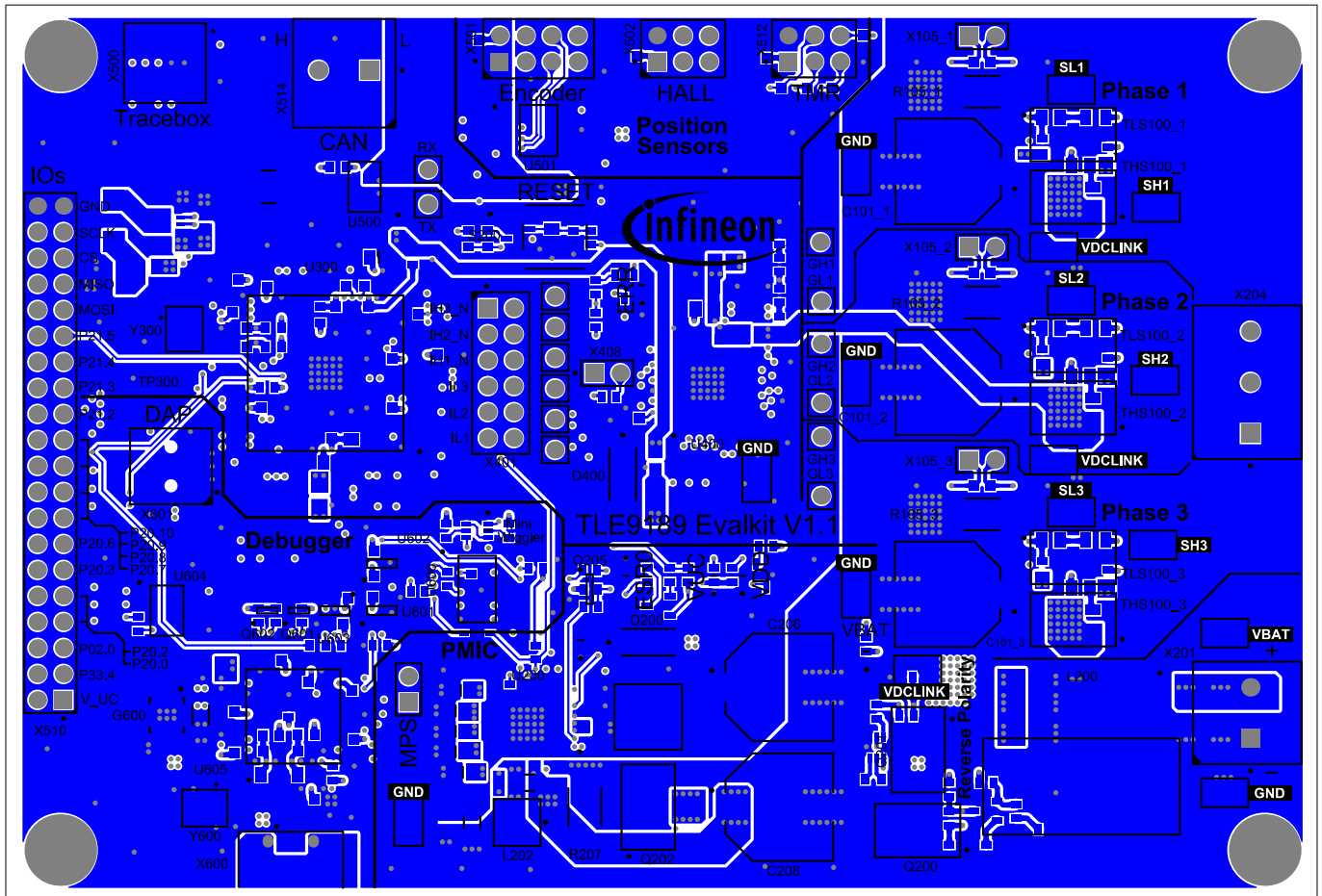

Figure 42 Layout of the evaluation kit - layer 6 - bottom

6.3 Bill of materials

For the design of the MOTIX™ Driver TLE9189 evaluation kit, automotive-qualified components are used. The complete bill of materials (BOM) is shown below, including non-fitted components.

Table 9 BOM for the MOTIX™ Driver TLE9189 evaluation kit

Designator	Manufacturer order number	Description	Quantity	Footprint
U604	93LC46B-I/SN	1 K Microwire compatible serial EEPROM	1	SOIC127P600X175-8 N-1
D200, D201, D400	B340AE-13	3.0 A Surface Mount Schottky Barrier Rectifier	3	DIOM5226X240N
C407, C500, C501, C502, C503	GCM1885G1H102FA1 6	CAP/CERA / 1 nF/50 V / 1% / X8G (Murata) / -55°C to 150°C / 0603(1608) / SMD / -	5	CAPC1608X90N
C404, C405	GCM21BR71H105KA 03	CAP / CERA / 1 uF / 50 V / 10% / X7R (EIA) / -55°C to 125°C / 0805(2012) / SMD /	2	CAPC2013X140N

(table continues...)

**6 Design files**
**Table 9 (continued) BOM for the MOTIX™ Driver TLE9189 evaluation kit**

Designator	Manufacturer order number	Description	Quantity	Footprint
C228, C410, C411, C412	GCM1885G1H222JA1 6	CAP / CERA / 2.2 nF / 50 V / 5% / X8G (Murata) / -55°C to 150°C / 0603(1608) / SMD /	4	CAPC1608X90N
C220, C221, C222, C223, C224, C225, C226, C227, C306, C308, C309	GRM219R71C225KE1 5	CAP / CERA / 2.2 uF / 16 V / 10% / X7R (EIA) / -55°C to 125°C / 0805(2012) / SMD /	11	CAPC2013X95N
C100_1, C100_2, C100_3, C402, C403, C406	CGA4J3X7R1H225K1 25AB	CAP / CERA / 2.2 uF / 50 V / 10% / X7R (EIA) / -55°C to 125°C / 0805 / SMD / -	6	CAPC2013X145N-2
C218, C219, C613	GRM21BR71C335KA 99	CAP / CERA / 3.3 uF / 16 V / 10% / X7R (EIA) / -55°C to 125°C / 0805(2012) / SMD / -	3	CAPC2013X135N
C229, C315, C600, C603	GCM21BC71A475KA 73	CAP / CERA / 4.7 uF / 10 V / 10% / X7S (EIA) / -55°C to 125°C / 0805(2012) / SMD / -	4	CAPC2013X140N
C203, C400	CGA4J1X7R1H475K1 25AE	CAP / CERA / 4.7 uF / 50 V / 10% / X7R (EIA) / -55°C to 125°C / 0805 / SMD / -	2	CAPC2012X150N
C205	GRM3195C2A562JA0 1	CAP / CERA / 5.6 nF / 100 V / 5% / C0G (EIA) / NP0 / -55°C to 125°C / 1206(3216) / SMD / -	1	CAPC3216X95N
C617, C620	GCM1885C1H8R0DA 16	CAP / CERA / 8 pF / 50 V / 500 fF / C0G (EIA) / NP0 / -55°C to 125°C / 0603(1608) / SMD / -	2	CAPC1608X90N
C104_1, C104_2, C104_3, C105_1, C105_2, C105_3, C106_1, C106_2, C106_3, C615	GCM188R71H103JA3 7	CAP / CERA / 10 nF / 50 V / 5% / X7R (EIA) / -55°C to 125°C / 0603(1608) / SMD / -	10	CAPC1608X90N
C317, C321	GCM1885C1H100FA1 6	CAP / CERA / 10 pF / 50 V / 1% / C0G (EIA) / NP0 / -55°C to 125°C / 0603(1608) / SMD / -	2	CAPC1608X90N
C217, C302, C318, C322	CGA4J1X7S1C106K1 25AC	CAP / CERA / 10 uF / 16 V / 10% / X7S (EIA) / -55°C to 125°C / 0805(2012) / SMD / -	4	CAPC2013X145N-2
C210, C211, C212, C213, C614	CGA5L1X7R1H106K1 60AC	CAP / CERA / 10 uF / 50 V / 10% / X7R (EIA) / -55°C to 125°C / 1206 / SMD / -, CAP / CERA / 10 uF / 50 V / 10% / X7R (EIA) / -55°C to 125°C / 1206(3216) / SMD / -	5	CAPC3216X190N

**(table continues...)**

**6 Design files**
**Table 9 (continued) BOM for the MOTIX™ Driver TLE9189 evaluation kit**

Designator	Manufacturer order number	Description	Quantity	Footprint
C216	G CJ31CR71A226ME0 1	CAP / CERA / 22 uF / 10 V / 20% / X7R (EIA) / -55°C to 125°C / 1206(3216) / SMD / -	1	CAPC3216X190N-3
C202, C204, C209, C214, C215, C300, C301, C304, C305, C307, C311, C312, C313, C314, C320, C323, C409, C504, C505, C506, C507, C508, C509, C601, C602, C604, C605, C606, C607, C608, C609, C610, C611, C612, C616, C618, C619, C621, C622, C623, C624	GCM188R71H104JA5 7, GCM188L81H104KA5 7, GCM188R71C104JA3 7	CAP / CERA / 100 nF / 50 V / 5% / X7R (EIA) / -55°C to 125°C / 0603(1608) / SMD / -, CAP / CERA / 100 nF / 50V / 10% / X8L (EIA) / -55°C to 150°C / 0603(1608) / SMD / -, CAP / CERA / 100 nF / 16 V / 5% / X7R (EIA) / -55°C to 125°C / 0603(1608) / SMD / -	41	CAPC1608X90N
C207	GCM188R71H224KA 64	CAP / CERA / 220 nF / 50 V / 10% / X7R (EIA) / -55°C to 125°C / 0603(1608) / SMD / -	1	CAPC1608X90N
C303, C316	GCM188R71C334JA3 7	CAP / CERA / 330 nF / 16 V / 5% / X7R (EIA) / -55°C to 125°C / 0603(1608) / SMD / -	2	CAPC1608X90N
C310, C401, C408	GCM188R71C474KA5 5, CGA3E3X7R1H474K0 80AE	CAP / CERA / 470nF / 16V / 10% / X7R (EIA) / -55°C to 125°C / 0603(1608) / SMD / -, CAP / CERA / 470 nF / 50 V / 10% / X7R (EIA) / -55°C to 125°C / 0603 / SMD / -	3	CAPC1608X90N, CAPC1708X95N
C200, C201	GCM188C71C684KA6 4	CAP / CERA / 680 nF / 16 V / 10% / X7S (EIA) / -55°C to 125°C / 0603(1608) / SMD / -	2	CAPC1608X90N
C206, C208	MAL214699103E3	CAP / ELCO / 100 uF / 50 V / 20% / Aluminiuelectrolytic / -55°C to 125°C / 10.50 mm L X 10.50 mm W X 10.50 mm H / SMD / -	2	CAPAE1050X1050N
C101_1, C101_2, C101_3	EEEFT1V561AP	CAP / ELCO / 560 uF / 35 V / 20% / - / -55°C to 105°C / 10.30 mm L X 10.30 mm W X 10.50 mm H / SMD / -	3	CAPAE1030X1050N
U501	ST26C32ABTR	CMOS quad 3-state differential line receiver	1	SOP65P640X120-16 N-1

**(table continues...)**

**6 Design files**
**Table 9 (continued) BOM for the MOTIX™ Driver TLE9189 evaluation kit**

Designator	Manufacturer order number	Description	Quantity	Footprint
Q204	MUN5311DW1T1G	Complementary bias resistor transistors	1	SOT65P210X110-6N-5
X500	FTSH-106-01-L-DV-K	Connector header surface mount 12 position 0.050 (1.27 mm)	1	CON-M-SMD-FTSH-106-01-L-DV-K
U605	FT2232HL	Dual high speed USB to multipurpose UART/FIFO IC	1	QFP50P1200X1200X160-64N
U200	TLF35585QV	Functional safety PMIC	1	QFN50P700X700X90-49N-3-1-V2
U300	SAL-TC364DP-64F300F AA	High performance microcontroller	1	QFP40P1800X1800X120-145N-3-V1
U500	TLE9351VSJ	High speed CAN transceiver, used in HS CAN system for automotive applications and industrial applications	1	SOIC127P602X173-8N
L600, L601	MMZ1608R300ATA00	IND / - / - / 1.5 A / 25% / - / - / 0603 (1608) / Inductor, Chip; 1.60 mm L X 0.80 mm W X 0.95 mm H / SMD / -	2	INDC1608X95N_MMZ1608
L300	CLF5030NIT-3R3N-D	IND / STD / 3.3 uH / 2.7 A / 30% / -55°C to 150°C / 52 mR / 5030 D Type / Inductor, Chip; 5.3 mm L X 5.00 mm W X 3 mm H / - / -	1	IND_CLF5030NI-D
L202	XAL4030-472ME	IND / STD / 4.7 uH / 5.1 A / 20% / -40°C to 125°C / 44.1R / SMD Type / Inductor, Chip; 4.00 mm L X 4.00 mm W X 3.10 mm H / SMD / -	1	XAL4030-472ME
L200	SER2013-472MLB	IND / STD / 4.7 uH / 18A / 20% / -40°C to 85°C / 1.82 mR / SMD / Inductor, SMD, 9.27 mm L X 19.18 mm W X 12.95 mm H / SMD / -	1	IND-SMD-SER2013
L201	XAL6060-223ME	IND / STD / 22 uH / 3.6A / 20% / -40°C to 125°C / 61 mR / SMD / DFN; 2 pin, 6.36 mm L X 6.56 mm W X 6.10 mm H / SMD / -	1	DFN636X656X610-2N
X600	ZX62D-AB-5P8(30)	Micro USB 2.0, latch-lock, 30 V rated voltage	1	CON-USB-SMD-ZX62D-AB-5P8(30)
Q203	BC817K-40R	NPN general-purpose transistor	1	SOT95P230X110-3N

**(table continues...)**

**6 Design files**
**Table 9 (continued) BOM for the MOTIX™ Driver TLE9189 evaluation kit**

Designator	Manufacturer order number	Description	Quantity	Footprint
Q206, Q207	BC848C	NPN silicon AF transistor	2	SOT95P240X110-3N
U600	SN74AHC244PWR	Octal buffer/driver with 3-state outputs	1	SOP65P640X120-20 N
Q202	IPC50N04S5-5R8	OptiMOS™-5 N-Channel enhancement mode power transistor, VDS 40 V	1	INF-PG-TDSON-8-33-V
Q600, Q601, Q602	BSD235N	OptiMOS™ 2 small-signal-Transistor 20 V	3	SOT65P210X100-6N
Q300	BSZ15DC02KD H	OptiMOS™ 2+ OptiMOS™-P Complementary P + N Channel enhancement 2 small signal transistor	1	INF-PG-TSDSON-8-31
Q200, Q201, THS100_1, THS100_2, THS100_3, TLS100_1, TLS100_2, TLS100_3	IAUC120N04S6N006	OptiMOS™ - power MOSFET for automotive applications, N-channel - enhancement mode - normal Level	8	INF-PG-TDSON-8-33-V
X201, X514	1792863	PCB terminal block, nominal current: 16 A, rated voltage : 400 V, 2 positions	2	CON-TER-THT-1792863
X204	1792876	PCB terminal block, nominal current: 12 A, nominal voltage: 400 V, 3 positions	1	CON-TER-THT-1792876
Q208, Q400	BC858C	PNP silicon AF transistor	2	SOT95P240X110-3N-1
G600	TLS203B0LD V33	Power, low noise, low dropout voltage regulator. Designed for use in battery-powered systems. Low quiescent current of 30 µA	1	SON50P330X330X110-11N-V
R212, R229, R300, R301, R304, R305, R306, R307, R308, R310, R313, R509, R510, R511, R512, R513, R515, R516, R611, R614, R622, R623, R628, R630, R631, R632	AC0603JR-070RL	RES / STD / 0R / 100 mW / 0R / 0 ppm/K / -55°C to 155°C / 0603 / SMD / -	26	RESC1608X55N-1
R220, R221, R232, R517, R518, R519, R612	CRCW06031K00FK	RES / STD / 1k / 100 mW / 1% / 100 ppm/K / -55°C to 155°C / 0603 / SMD / -	7	RESC1609X50N

**(table continues...)**

**6 Design files**
**Table 9 (continued) BOM for the MOTIX™ Driver TLE9189 evaluation kit**

Designator	Manufacturer order number	Description	Quantity	Footprint
R633	CRCW06031M00FK	RES / STD / 1MEG / 100 mW / 1% / 100 ppm/K / -55°C to 155°C / 0603(1608) / SMD / -	1	RESC1609X50N
R303	CRCW06031R20FK	RES/STD / 1.2 R/100 mW / 1% / 100 ppm/K / -55°C to 155°C / 0603 / SMD / -	1	RESC1609X50N
R233	CRCW06031K50FK	RES / STD / 1.5 k / 100 mW / 1% / 100 ppm/K / -55°C to 155°C / 0603 / SMD / -	1	RESC1609X50N
R104_1, R104_2, R104_3, R106_1, R106_2, R106_3, R409	CRCW06032R00FK	RES / STD / 2 R / 100 mW / 1% / 100 ppm/K / -55°C to 155°C / 0603 / SMD / -	7	RESC1609X50N
R211, R629	CRCW06032K20FK	RES / STD / 2.2 k / 100 mW / 1% / 100 ppm/K / -55°C to 155°C / 0603 / SMD / -	2	RESC1609X50N
R202	CRCW06033K30FK	RES / STD / 3.3 k / 100 mW / 1% / 100 ppm/K / -55°C to 155°C / 0603(1608) / SMD / -	1	RESC1609X50N
R205, R209, R230, R237, R314, R615, R619, R624, R625	CRCW06034K70FK	RES / STD / 4.7 k / 100 mW / 1% / 100 ppm/K / -55°C to 155°C / 0603 / SMD / -, RES / STD / 4.7 k / 100 mW / 1% / 100 ppm/K / -55°C to 155°C / 0603(1608) / SMD / -	9	RESC1609X50N
R105_1, R105_2, R105_3	ERJMS4HF5M0U	RES / STD / 5 mR / 3 W / 1% / 75 ppm/K / -65°C to 170°C / 2512(6332) / SMD / -	3	RESC6431X123N
R606	CRCW06035K10FK	RES / STD / 5.1 k / 100 mW / 1% / 100 ppm/K / -55°C to 155°C / 0603 / SMD / -	1	RESC1609X50N
R214, R215	CRCW06036K04FK	RES / STD / 6.04 k / 100 mW / 1% / 100 ppm/K / -55°C to 155°C / 0603 / SMD / -	2	RESC1609X50N
R408	CRCW06036K80FK	RES / STD / 6.8 k / 100 mW / 1% / 100 ppm/K / -55°C to 155°C / 0603(1608) / SMD / -	1	RESC1609X50N
R302	CRCW06036R80FK	RES/STD / 6.8 R/100 mW / 1% / 100 ppm/K / -55°C to 155°C / 0603 / SMD / -	1	RESC1609X50N

**(table continues...)**

**6 Design files**
**Table 9 (continued) BOM for the MOTIX™ Driver TLE9189 evaluation kit**

Designator	Manufacturer order number	Description	Quantity	Footprint
R200, R201, R227, R228, R231, R238, R400, R410, R600, R601, R602, R605, R610, R616, R617, R618, R620, R621, R626, R627	CRCW060310K0FKE A	RES / STD / 10 k / 100 mW / 1% / 100 ppm/K / -55°C to 155°C / 0603 / SMD / -	20	RESC1609X50N
R613	CRCW060312K0FKE A	RES / STD / 12 k / 100 mW / 1% / 100 ppm/K / -55°C to 155°C / 0603 / SMD / -	1	RESC1609X50N
R226	CRCW060320K0FK	RES / STD / 20 k / 100 mW / 1% / 100 ppm/K / -55°C to 155°C / 0603 / SMD / -	1	RESC1609X50N
R311, R312, R402	CRCW060325R5FK	RES / STD / 25.5 R / 10 0mW / 1% / 100 ppm/K / -55°C to 155°C / 0603(1608) / SMD / -	3	RESC1609X50N
R608, R609	CRCW060327R0FK	RES / STD / 27 R / 100 mW / 1% / 100 ppm/K / -55°C to 155°C / 0603 / SMD / -	2	RESC1609X50N
R210, R213	CRCW060328K7FK	RES / STD / 28.7 k / 100 mW / 1% / 100 ppm/K / -55°C to 155°C / 0603 / SMD / -	2	RESC1609X50N
R309	CRCW060333R0FK	RES / STD / 33 R / 100 mW / 1% / 100 ppm/K / -55°C to 155°C / 0603(1608) / SMD / -	1	RESC1609X50N
R204, R206, R208	CRCW060347K0FK	RES / STD / 47 k / 100 mW / 1% / 100 ppm/K / -55°C to 155°C / 0603 / SMD / -	3	RESC1609X50N
R207	WSL2512R0500FEA	RES / STD / 50 mR / 1 W / 1% / 75 ppm/K / -65°C to 170°C / 2512 / SMD / -	1	RESC6432X89N-1_4p
R403, R405, R406, R407	CRCW060350R0FK	RES / STD / 50 R / 100 mW / 1% / 100 ppm/K / -55°C to 155°C / 0603 / SMD / -	4	RESC1609X50N
R223, R224	CRCW060351K0FK	RES / STD / 51 k / 100 mW / 1% / 100 ppm/K / -55°C to 155°C / 0603 / SMD / -	2	RESC1609X50N
R234	CRCW060382K0FK	RES / STD / 82 k / 100 mW / 1% / 100 ppm/K / -55°C to 155°C / 0603 / SMD / -	1	RESC1609X50N

**(table continues...)**

**6 Design files**
**Table 9 (continued) BOM for the MOTIX™ Driver TLE9189 evaluation kit**

Designator	Manufacturer order number	Description	Quantity	Footprint
R101_1, R101_2, R101_3, R103_1, R103_2, R103_3, R225	CRCW0603100KFK	RES / STD / 100 k / 100 mW / 1% / 100 ppm/K / -55°C to 155°C / 0603 / SMD / -	7	RESC1609X50N
R235, R401, R514	CRCW0603120RFK	RES / STD / 120 R / 100 mW / 1% / 100 ppm/K / -55°C to 155°C / 0603 / SMD / -	3	RESC1609X50N
R222	CRCW0603470RFK	RES / STD / 470 R / 100 mW / 1% / 100 ppm/K / -55°C to 155°C / 0603 / SMD / -	1	RESC1609X50N
R603	CRCW0603680RFK	RES / STD / 680 R / 100 mW / 1% / 100 ppm/K / -55°C to 155°C / 0603 / SMD / -	1	RESC1609X50N
D601	BAT54-03W	Silicon Schottky diode	1	SOD2513X110N-2
U601	SN74LVC1G125DBVR	Single bus buffer gate with 3-state output	1	SOT95P280X145-5N-2
U602, U603	SN74LVC1T45DBVR	Single-bit dual-supply bus transceiver with configurable voltage Translation and 3-state outputs (operating temp -40°C to 85°C)	2	SOT95P280X145-6N-6
Q205	BSS138NH6433XTM A1	SIPMOS small-signal-transistor, VDS 60 V	1	SOT95P240X110-3N-1-V1
Y600	NX3225SA-12.000M-STD-CRS-2	SMD crystal unit for automotive application, 12.000 MHz	1	XTAL-SMD-NX3225SA
Y300	NX3225SA-20.000M-STD-CRS-2	SMD crystal unit for automotive application, 20.000 MHz	1	XTAL-SMD-NX3225SA
X601	FTSH-105-01-L-DV-K-A-TR	SMT micro header, 1.27 mm pitch, 10 pin, vertical, double row, keying shroud with alignment pin, DAP	1	CON-M-SMD-FTSH-105-01-L-DV-K-A-TR
D203, D205, D206, D207, D600	TLMG1100-GS08	Standard 0603 SMD LED	5	LEDC1608X65N-1
D208, D401	TLMS1100-GS08	Standard 0603 SMD LED, 2.1 V red, luminous intensity 63 mcd	2	LEDC1608X65N-1
D202, D204	1N4148W-7-F	Surface mount fast switching diode	2	SOD3715X145N

**(table continues...)**



**6 Design files**

**Table 9 (continued) BOM for the MOTIX™ Driver TLE9189 evaluation kit**

<b>Designator</b>	<b>Manufacturer order number</b>	<b>Description</b>	<b>Quantity</b>	<b>Footprint</b>
X100_1, X100_2, X100_3, X102_1, X102_2, X102_3, X104_1, X104_2, X104_3, X106_1, X106_2, X106_3, X200, X205, X206, X400	5019	Test point, compact, surface mount, finish- silver plate	16	CON-SMD-TP-5019
U400 (1)	TLE9189QVW	Three-phase bridge driver	1	TLE9189-QFNP
U400 (2)	TLE9189QUW	Three-phase bridge driver	1	TLE9189-QFNP
X101_1, X101_2, X101_3, X103_1, X103_2, X103_3, X402, X403, X404, X405, X406, X407, X503, X504	TSW-101-07-L-S	Through hole .025 SQ post header, 1 pin, vertical	14	CON-M-THT-TSW-101-07-L-S
X105_1, X105_2, X105_3, X202, X408	HTSW-102-07-L-S	Through hole .025 SQ post header, 2.54 mm pitch, 2 pin, vertical, single row	5	HDRV2W64P254_1X2_496X248X838B
X502, X512	TSW-103-07-L-D	Through hole .025 SQ post header, 2.54 mm pitch, 6 pin, vertical, double row	2	HDRV6W64P254_2X3_762X508X898B
X501	TSW-104-07-L-D	Through hole .025 SQ post header, 2.54 mm pitch, 8 pin, vertical, double row	1	CON-M-THT-TSW-104-07-L-D
X401	TSW-106-07-L-D	Through hole .025 SQ post header, 2.54 mm pitch, 12 pin, vertical, double row	1	CON-M-THT-TSW-106-07-L-D
X510	TSW-120-07-L-D	Through hole .025 SQ post header, 2.54 mm pitch, 40 pin, vertical, double row	1	HDRV40W64P254_2X20_5086X508X838B
MP600	3025033-01	USB 4P(A)/M - micro USB 5P(B)/M	1	3025033-01
S200	430182043816	WS-TASV SMT tact switch, normally open 1, 3:2, 4	1	SW-SMD-430182043816

**6 Design files**

**Table 10 BOM of MOTIX™ Driver TLE9189 evaluation kit, optional components**

<b>Designator</b>	<b>Manufacturer order number</b>	<b>Description</b>	<b>Quantity</b>	<b>Footprint</b>
C102_1, C102_2, C102_3, C103_1, C103_2, C103_3	GCM2165G1H202JA16	CAP / CERA / 2 nF / 50 V / 5% / X8G (Murata) / -55°C to 150°C / 0805(2012) / SMD		CAPC2013X70N-0
C319	CGA3E1X7R1V105K080AC	CAP / CERA / 1 uF / 35 V / 10% / X7R (EIA) / -55°C to 125°C / 0603(1608) / SMD		CAPC1608X90N-4
L500	B82789C0104N002	IND / - / 100 uH / 150 mA / 50% / - / - / SMD Type / Choke, 4-Leads, Molded Body 5.2 mm L X 3.20 mm W X 3.00 mm H / SMD	0	B82789-C0104
R100_1, R100_2, R100_3, R102_1, R102_2, R102_3	CRCW08052R00FKEAHP	RES / STD / 2 R / 500 mW / 1% / 100 ppm/K / - / 0805(2012) / SMD	0	RESC2013X60N-3
R203, R404, R604, R607	AC0603JR-070RL	RES / STD / 0R / 100 mW / 0R / 0 ppm/K / -55°C to 155°C / 0603 / SMD	0	RESC1608X55N-1

## **7 Glossary additional abbreviations**

### **7.1 Glossary**

#### **BLDC**

*brushless direct current (BLDC)*

#### **CAN**

*controller area network (CAN)*

#### **CSA**

*current-sense amplifier (CSA)*

Special-purpose amplifiers that output a voltage proportional to the current flowing in a power rail. They utilize a "current-sense resistor" to convert the load current in the power rail to a small voltage, which is then amplified by the current-sense amplifiers.

#### **DC**

*direct current (DC)*

One-directional flow of electric charge. An electrochemical cell is a prime example of DC power. Direct current may flow through a conductor such as a wire, but can also flow through semiconductors, insulators, or even through a vacuum as in electron or ion beams. The electric current flows in a constant direction, distinguishing it from alternating current (AC).

#### **GND**

*ground (GND)*

#### **GPIO**

*general purpose input output (GPIO)*

#### **GUI**

*graphical user interface (GUI)*

An interface that enables users to interact with electronic devices through icons and visual indicators.

#### **IC**

*integrated circuit (IC)*

A miniature electronic circuit built on the surface of a thin substrate of a semiconductor material.

#### **LED**

*light-emitting diode (LED)*

A semiconductor circuit that emits light when activated.

#### **PCB**

*printed circuit board (PCB)*

A board that mechanically supports and electrically connects electronic components using conductive tracks, pads, and other features etched from copper sheets laminated onto a non-conductive substrate.

## 7 Glossary additional abbreviations

### **SPI**

*serial peripheral interface (SPI)*

A synchronous serial communication interface specification used for inter-chip communication, primarily in embedded systems.

### **TMR**

*tunnel magnetoresistance (TMR)*

A magnetoresistive phenomenon that occurs in a magnetic tunnel junction, used for example, for sensors.

### **USB**

*universal serial bus (USB)*

An industry standard that defines cables, connectors, and communication protocols used in a bus for connection, communication, and power supply between computers and electronic devices.

## 7.2 Additional abbreviations

**Table 11**      **Abbreviations**

GHx	Gate high-side MOSFETs
GLx	Gate low-side MOSFETs
ISNx	Negative current sense input
ISPx	Positive current sense input
N.C.	Not connected
n/u	Not used
PORST	Power-on reset
SH	Source high-side MOSFET
SL	Source low-side MOSFET
SOFF_N	Negated safe switch off
UART	Universal asynchronous receiver transmitter
VBAT	Battery voltage
VDD	Voltage drain-to-drain (core supply voltage)
VUC/V_UC	Microcontroller supply voltage

## **8 References**

- [1] TLE9189 datasheet available on [www.infineon.com](http://www.infineon.com)
- [2] TLE9189 user manual available on [www.infineon.com](http://www.infineon.com)
- [3] IAUC120N04S6N006, Infineon's OptiMOS™ 6 40 V power MOS [webpage](#)
- [4] OPTIREG™ PMIC TLF35585QVS02 datasheet available on [infineon webpage](#)
- [5] SAL-TC364DP-64F300F AA, Aurix™ microcontroller [webpage](#)
- [6] MOTIX™ BLDC Motor Gate Driver IC Configuration Wizard available on the [Infineon IDC](#)
- [7] MOTEON TraceBox [webpage](#)

---

**Revision history**

## **Revision history**

<b>Document version</b>	<b>Date of release</b>	<b>Description of changes</b>
Rev. 1.00	2024-08-28	<ul style="list-style-type: none"><li>Initial document release</li></ul>

#### **Trademarks**

All referenced product or service names and trademarks are the property of their respective owners.

**Edition 2024-08-28**

**Published by**

**Infineon Technologies AG**

**81726 Munich, Germany**

**© 2024 Infineon Technologies AG**

**All Rights Reserved.**

**Do you have a question about any aspect of this document?**

**Email: [erratum@infineon.com](mailto:erratum@infineon.com)**

**Document reference**

**IFX-cdz1721112304905**

For further information on the product, technology, delivery terms and conditions and prices please contact your nearest Infineon Technologies office ([www.infineon.com](http://www.infineon.com))

#### **Warnings**

Due to technical requirements products may contain dangerous substances. For information on the types in question please contact your nearest Infineon Technologies office.

Except as otherwise explicitly approved by Infineon Technologies in a written document signed by authorized representatives of Infineon Technologies, Infineon Technologies' products may not be used in any applications where a failure of the product or any consequences of the use thereof can reasonably be expected to result in personal injury.

# Mouser Electronics

Authorized Distributor

Click to View Pricing, Inventory, Delivery & Lifecycle Information:

[Infineon:](#)

[EVALKITTLE9189QUWTOBO1](#) [EVALKITTLE9189QVWTOBO1](#)