

IRFI4020H-117P

Features

- Integrated half-bridge package
- Reduces the part count by half
- Facilitates better PCB layout
- Key parameters optimized for Class-D audio amplifier applications
- Low $R_{DS(ON)}$ for improved efficiency
- Low Q_g and Q_{sw} for better THD and improved efficiency
- Low Q_{rr} for better THD and lower EMI
- Can delivery up to 300W per channel into 8Ω load in half-bridge configuration amplifier
- Lead-free package

Key Parameters ⑤		
V_{DS}	200	V
$R_{DS(ON)}$ typ. @ 10V	80	mΩ
Q_g typ.	19	nC
Q_{sw} typ.	6.8	nC
$R_{G(int)}$ typ.	3.0	Ω
T_J max	150	°C

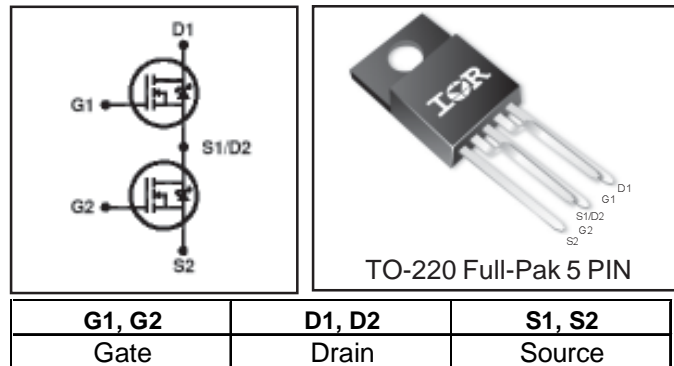

Description

This Digital Audio MosFET Half-Bridge is specifically designed for Class D audio amplifier applications. It consists of two power MosFET switches connected in half-bridge configuration. The latest process is used to achieve low on-resistance per silicon area. Furthermore, Gate charge, body-diode reverse recovery, and internal Gate resistance are optimized to improve key Class D audio amplifier performance factors such as efficiency, THD and EMI. These combine to make this Half-Bridge a highly efficient, robust and reliable device for Class D audio amplifier applications.

Absolute Maximum Ratings ⑤

	Parameter	Max.	Units
V_{DS}	Drain-to-Source Voltage	200	V
V_{GS}	Gate-to-Source Voltage	±20	
I_D @ $T_C = 25^\circ\text{C}$	Continuous Drain Current, V_{GS} @ 10V	9.1	A
I_D @ $T_C = 100^\circ\text{C}$	Continuous Drain Current, V_{GS} @ 10V	5.7	
I_{DM}	Pulsed Drain Current ①	36	
P_D @ $T_C = 25^\circ\text{C}$	Power Dissipation ④	21	W
P_D @ $T_C = 100^\circ\text{C}$	Power Dissipation ④	8.5	
	Linear Derating Factor	0.17	W/°C
E_{AS}	Single Pulse Avalanche Energy②	130	mJ
T_J	Operating Junction and	-55 to + 150	°C
T_{STG}	Storage Temperature Range		
	Soldering Temperature, for 10 seconds (1.6mm from case)	300	
	Mounting torque, 6-32 or M3 screw	10lb·in (1.1N·m)	

Thermal Resistance ⑤

	Parameter	Typ.	Max.	Units
$R_{\theta JC}$	Junction-to-Case ④	—	5.9	°C/W
$R_{\theta JA}$	Junction-to-Ambient (free air)	—	65	

Electrical Characteristics @ $T_J = 25^\circ\text{C}$ (unless otherwise specified) ⑤

	Parameter	Min.	Typ.	Max.	Units	Conditions
BV_{DSS}	Drain-to-Source Breakdown Voltage	200	—	—	V	$V_{GS} = 0V, I_D = 250\mu A$
$\Delta BV_{DSS}/\Delta T_J$	Breakdown Voltage Temp. Coefficient	—	24	—	mV/°C	Reference to $25^\circ\text{C}, I_D = 1mA$
$R_{DS(on)}$	Static Drain-to-Source On-Resistance	—	80	100	mΩ	$V_{GS} = 10V, I_D = 5.5A$ ③
$V_{GS(th)}$	Gate Threshold Voltage	3.0	—	4.9	V	$V_{DS} = V_{GS}, I_D = 100\mu A$
$\Delta V_{GS(th)}/\Delta T_J$	Gate Threshold Voltage Coefficient	—	-12	—	mV/°C	
I_{DSS}	Drain-to-Source Leakage Current	—	—	20	μA	$V_{DS} = 200V, V_{GS} = 0V$
		—	—	250		$V_{DS} = 200V, V_{GS} = 0V, T_J = 125^\circ\text{C}$
I_{GSS}	Gate-to-Source Forward Leakage	—	—	100	nA	$V_{GS} = 20V$
	Gate-to-Source Reverse Leakage	—	—	-100		$V_{GS} = -20V$
g_{fs}	Forward Transconductance	11	—	—	S	$V_{DS} = 50V, I_D = 5.5A$
Q_g	Total Gate Charge	—	19	29	nC	$V_{DS} = 100V$ $V_{GS} = 10V$ $I_D = 5.5A$ See Fig. 6 and 15
Q_{gs1}	Pre-Vth Gate-to-Source Charge	—	4.9	—		
Q_{gs2}	Post-Vth Gate-to-Source Charge	—	0.95	—		
Q_{gd}	Gate-to-Drain Charge	—	5.8	—		
Q_{godr}	Gate Charge Overdrive	—	7.4	—		
Q_{sw}	Switch Charge ($Q_{gs2} + Q_{gd}$)	—	6.8	—		
$R_{G(int)}$	Internal Gate Resistance	—	3.0	—	Ω	
$t_{d(on)}$	Turn-On Delay Time	—	8.4	—	ns	$V_{DD} = 100V, V_{GS} = 10V$ ③ $I_D = 5.5A$ $R_G = 2.4\Omega$
t_r	Rise Time	—	8.0	—		
$t_{d(off)}$	Turn-Off Delay Time	—	18	—		
t_f	Fall Time	—	4.0	—		
C_{iss}	Input Capacitance	—	1240	—	pF	$V_{GS} = 0V$ $V_{DS} = 25V$ $f = 1.0MHz,$ See Fig. 5 $V_{GS} = 0V, V_{DS} = 0V$ to $160V$
C_{oss}	Output Capacitance	—	130	—		
C_{riss}	Reverse Transfer Capacitance	—	28	—		
$C_{oss\ eff.}$	Effective Output Capacitance	—	110	—		
L_D	Internal Drain Inductance	—	4.5	—	nH	Between lead, 6mm (0.25in.) from package and center of die contact
L_S	Internal Source Inductance	—	7.5	—		

Diode Characteristics ⑤

	Parameter	Min.	Typ.	Max.	Units	Conditions
$I_S @ T_C = 25^\circ\text{C}$	Continuous Source Current (Body Diode)	—	—	9.1	A	MOSFET symbol showing the integral reverse p-n junction diode.
I_{SM}	Pulsed Source Current (Body Diode) ①	—	—	36		
V_{SD}	Diode Forward Voltage	—	—	1.3	V	$T_J = 25^\circ\text{C}, I_S = 5.5A, V_{GS} = 0V$ ③
t_{rr}	Reverse Recovery Time	—	76	110	ns	$T_J = 25^\circ\text{C}, I_F = 5.5A, V_{DD} = 160V$
Q_{rr}	Reverse Recovery Charge	—	230	350	nC	$di/dt = 100A/\mu s$ ③

Notes:

- ① Repetitive rating; pulse width limited by max. junction temperature.
- ② Starting $T_J = 25^\circ\text{C}, L = 8.6mH, R_G = 25\Omega, I_{AS} = 5.5A$.
- ③ Pulse width $\leq 400\mu s$; duty cycle $\leq 2\%$.
- ④ R_{θ} is measured at T_J of approximately 90°C .
- ⑤ Specifications refer to single MosFET.

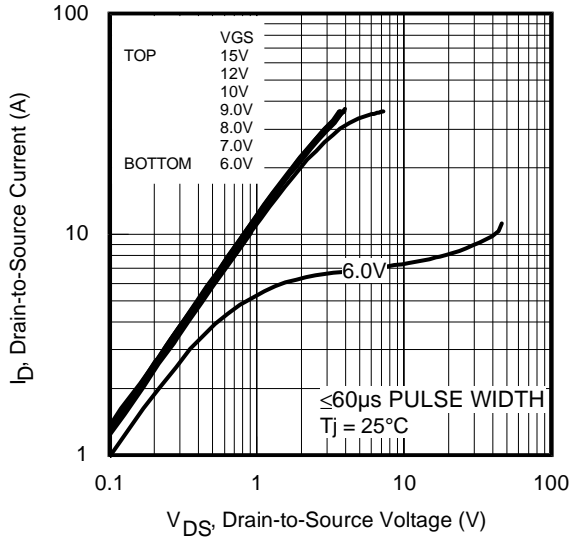

Fig 1. Typical Output Characteristics

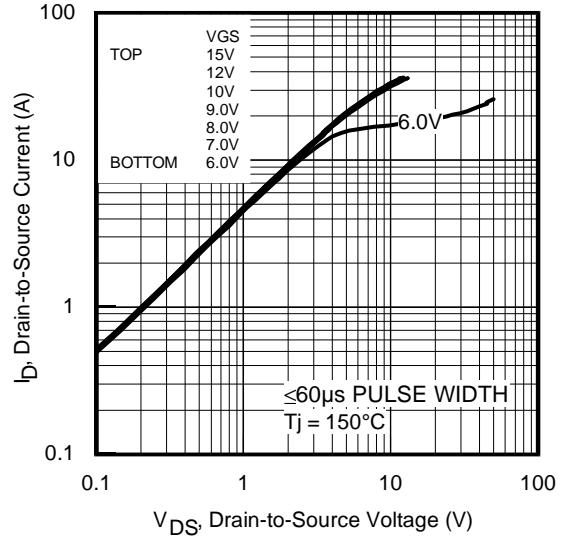

Fig 2. Typical Output Characteristics

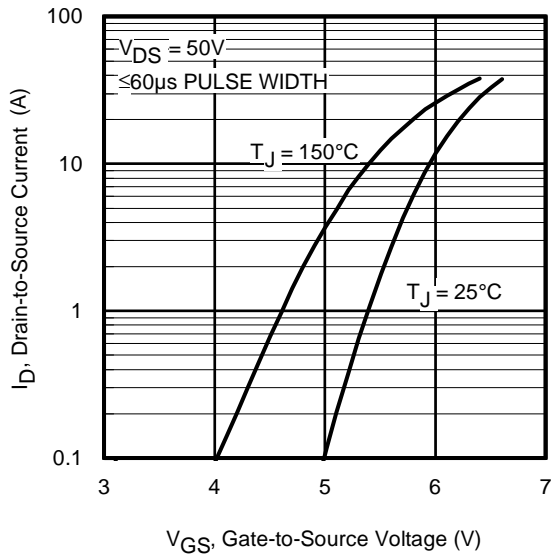

Fig 3. Typical Transfer Characteristics

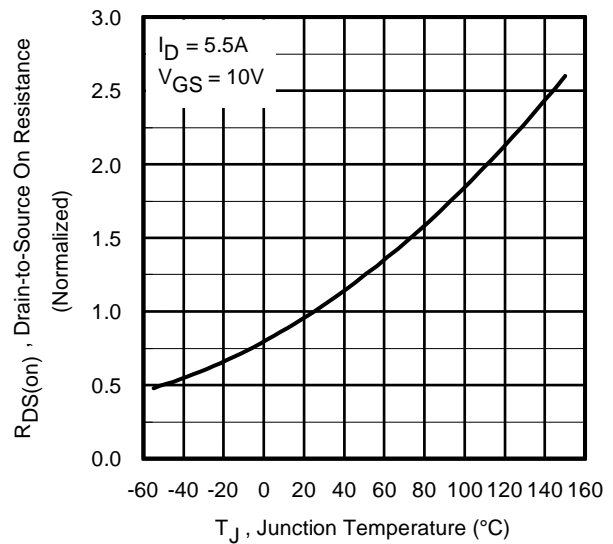

Fig 4. Normalized On-Resistance vs. Temperature

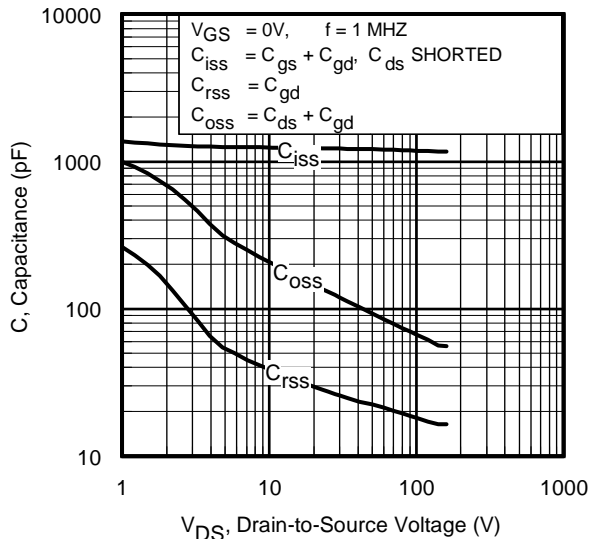

Fig 5. Typical Capacitance vs. Drain-to-Source Voltage
 www.irf.com

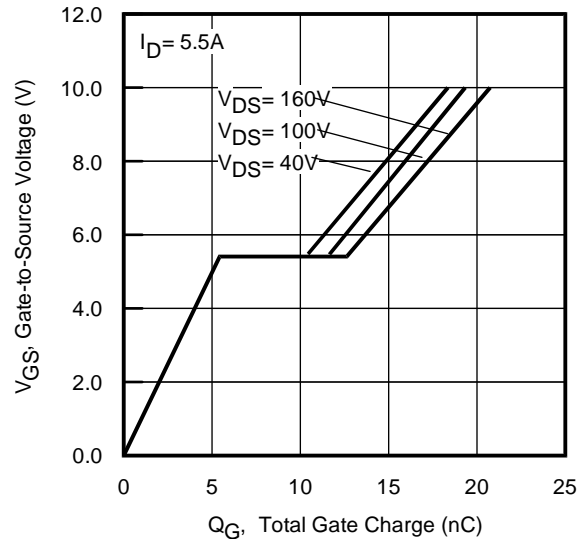

Fig 6. Typical Gate Charge vs. Gate-to-Source Voltage

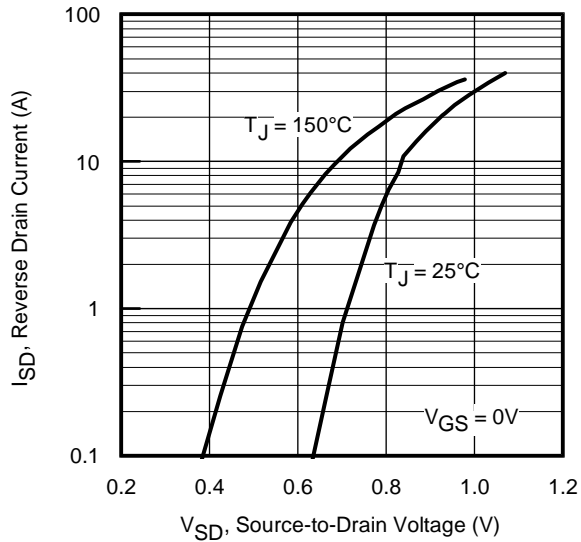

Fig 7. Typical Source-Drain Diode Forward Voltage

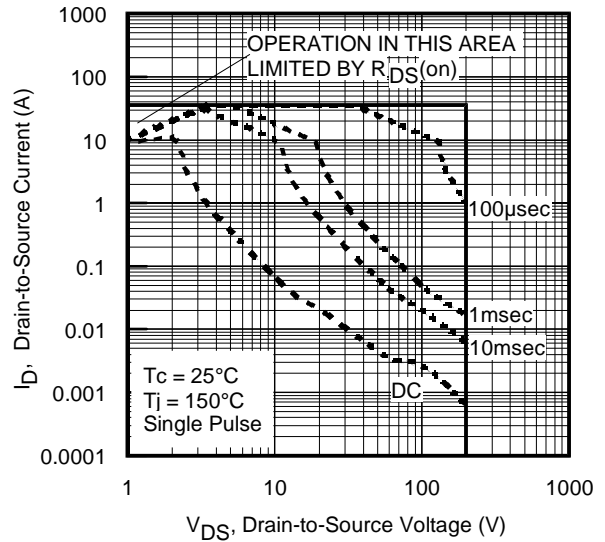

Fig 8. Maximum Safe Operating Area

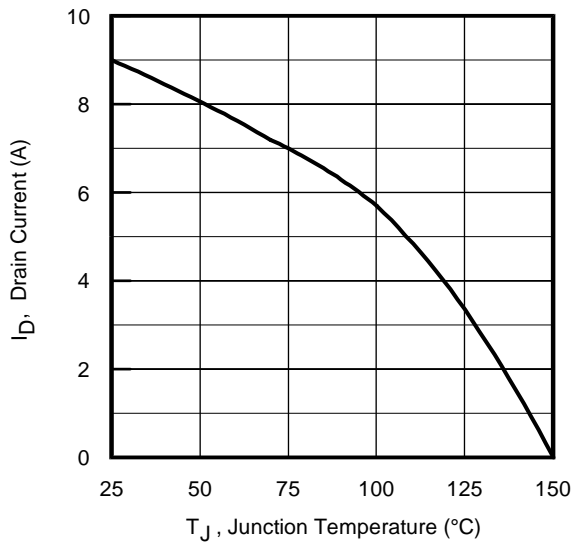

Fig 9. Maximum Drain Current vs. Junction Temperature

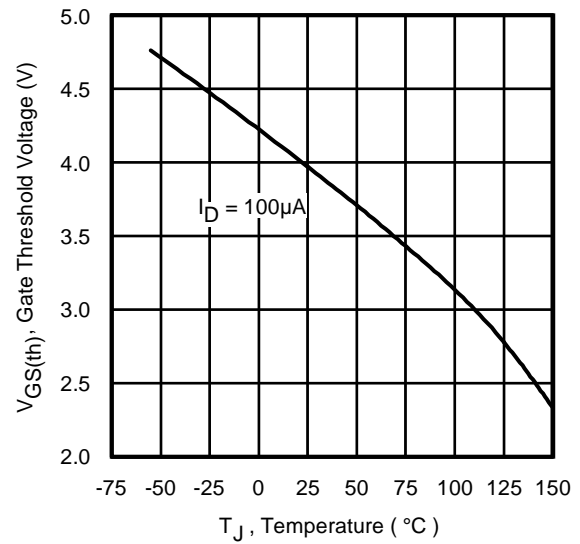

Fig 10. Threshold Voltage vs. Temperature

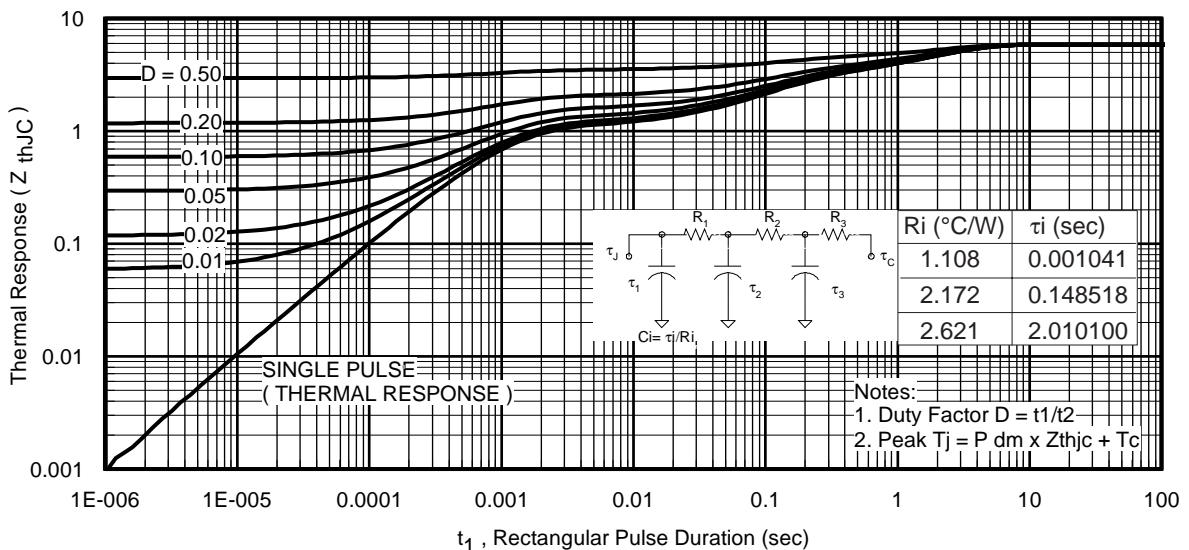

Fig 11. Maximum Effective Transient Thermal Impedance, Junction-to-Case

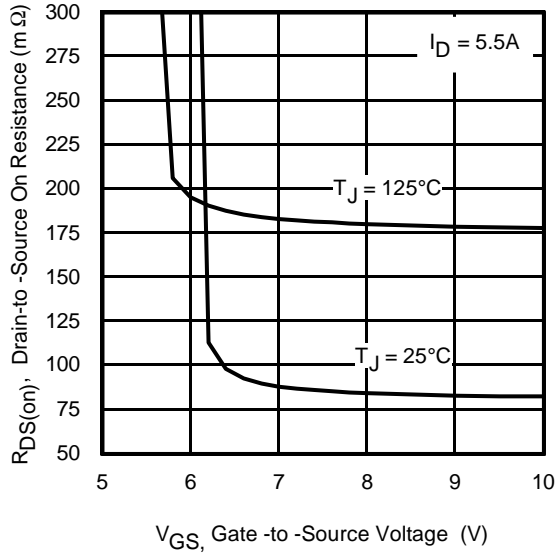

Fig 12. On-Resistance vs. Gate Voltage

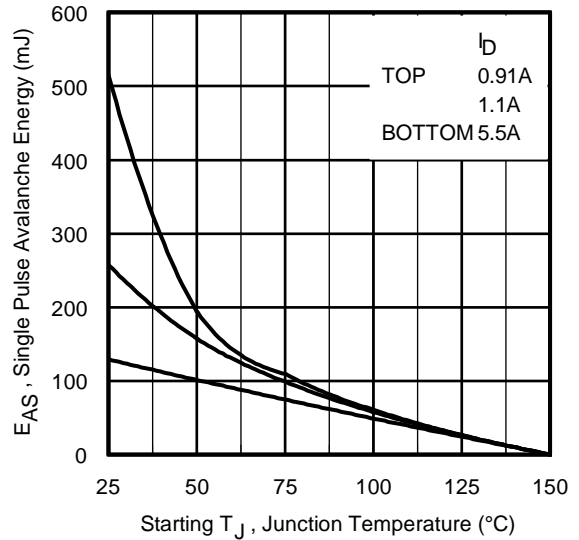

Fig 13a. Maximum Avalanche Energy vs. Drain Current

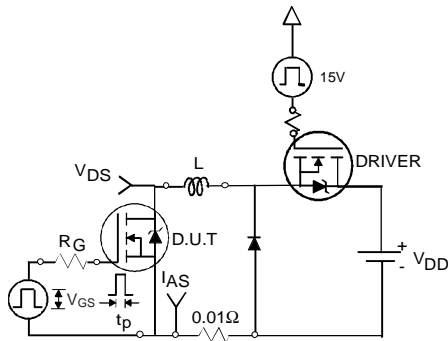

Fig 13b. Unclamped Inductive Test Circuit

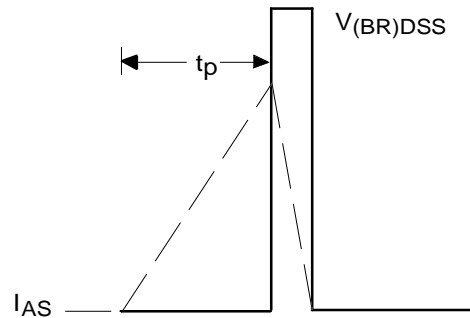

Fig 13c. Unclamped Inductive Waveforms

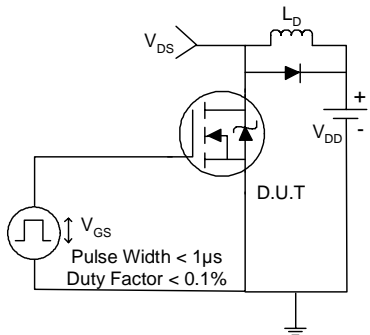

Fig 14a. Switching Time Test Circuit

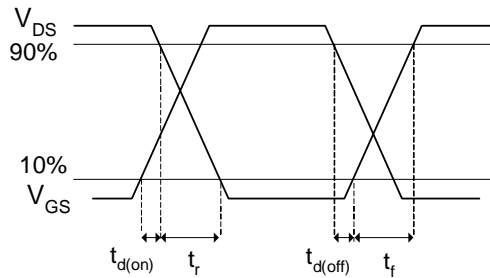

Fig 14b. Switching Time Waveforms

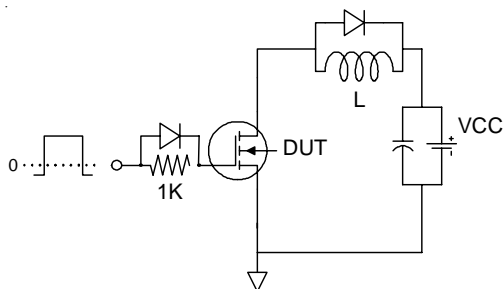

Fig 15a. Gate Charge Test Circuit

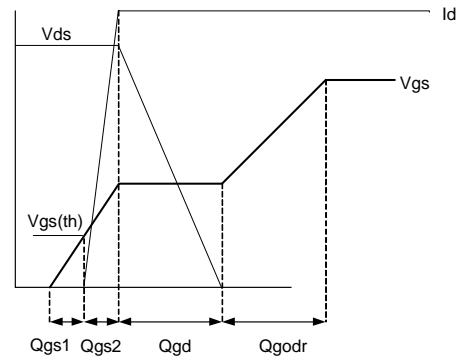
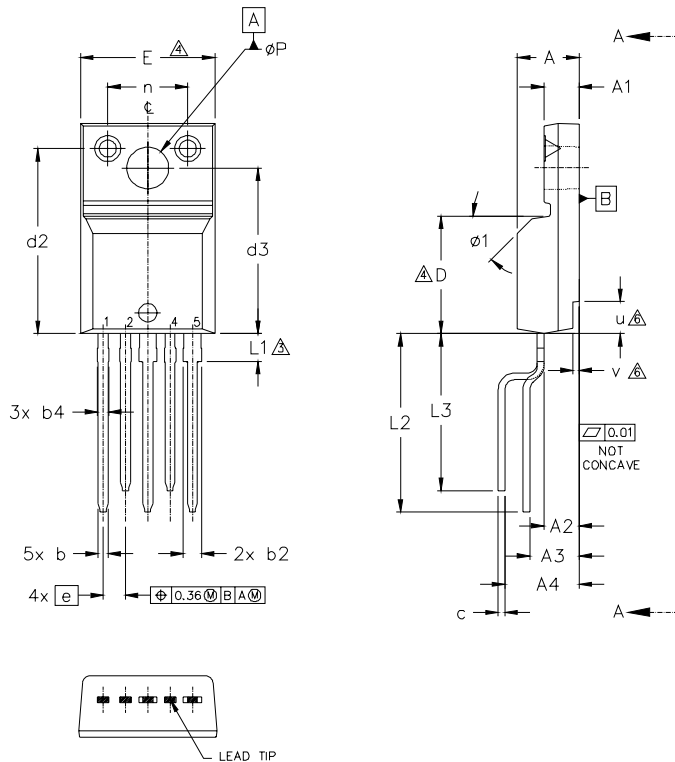

Fig 15b Gate Charge Waveform

IRFI4020H-117P

TO-220 Full-Pak 5-Pin Package Outline, Lead-Form Option 117

(Dimensions are shown in millimeters (inches))



NOTES:

- 1.0 DIMENSIONING AND TOLERANCING AS PER ASME Y14.5 M- 1994.
- 2.0 DIMENSIONS ARE SHOWN IN MILLIMETERS [INCHES].
- 3.0 LEAD DIMENSION AND FINISH UNCONTROLLED IN L1.
- 4.0 DIMENSION D & E DO NOT INCLUDE MOLD FLASH. MOLD FLASH SHALL NOT EXCEED .005" (0.127) PER SIDE. THESE DIMENSIONS ARE MEASURED AT THE OUTER MOST EXTREMES OF THE PLASTIC BODY.
- 5.0 DIMENSION b1, b3, b5 & c1 APPLY TO BASE METAL ONLY.
- 6.0 STEP OPTIONAL ON PLASTIC BODY DEFINED BY DIMENSIONS u & v.
- 7.0 CONTROLLING DIMENSION : INCHES.

SYMBOL	DIMENSIONS				NOTES
	MILLIMETERS		INCHES		
	MIN.	MAX.	MIN.	MAX.	
A	4.57	4.83	.180	.190	
A1	2.57	2.83	.101	.111	
A2	2.51	2.85	.099	.112	
A3	3.73	4.24	.147	.167	
A4	5.79	6.29	.228	.248	
b	0.61	0.95	0.24	.037	
b1	0.56	0.90	.022	0.35	5
b2	1.13	1.48	0.44	.058	
b3	1.08	1.43	0.42	.056	5
b4	0.76	1.06	.030	.042	
b5	0.71	1.01	.028	.040	5
c	0.33	0.63	.013	.025	
c1	0.28	0.58	.011	.023	5
D	8.65	9.80	.341	.386	4
d1	15.80	16.12	.622	.635	
d2	13.97	14.22	.550	.560	
d3	12.30	12.92	.484	.509	
E	9.63	10.63	.379	.419	4

SYMBOL	DIMENSIONS				NOTES
	MILLIMETERS		INCHES		
	MIN.	MAX.	MIN.	MAX.	
e	1.70	BSC	.067	BSC	
L	13.20	13.73	.520	.541	3
L1	1.91	2.31	.075	.091	
L2	12.7	13.46	.500	.530	
L3	10.92	11.68	.430	.460	
n	6.05	6.15	.238	.242	
øP	3.05	3.45	.120	.136	
u	2.40	2.50	.094	.098	6
v	0.40	0.50	.016	.020	
ø1	-	45°	-	45°	

LEAD ASSIGNMENTS

- 1 - SOURCE 2
- 2 - GATE 2
- 3 - DRAIN 2 / SOURCE 1
- 4 - GATE 1
- 5 - DRAIN 1

TO-220 Full-Pak 5-Pin Part Marking Information

EXAMPLE: THIS IS AN IRFI4020H WITH
LOT CODE 8024
ASSEMBLED ON WW02.2000
IN THE ASSEMBLY LINE "L"

Note: "P" in assembly line position indicates "Lead Free"

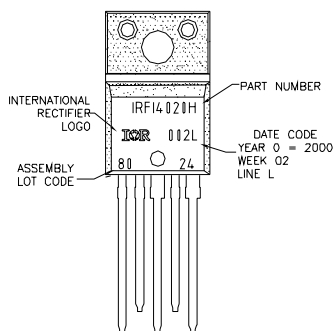

OR

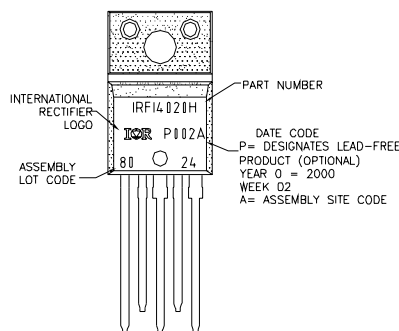

TO-220AB Full-Pak 5-Pin package is not recommended for Surface Mount Application.

Data and specifications subject to change without notice.
This product has been designed for the Consumer market.
Qualification Standards can be found on IR's Web site.

Note: For the most current drawings please refer to the IR website at:
<http://www.irf.com/package/>

IMPORTANT NOTICE

The information given in this document shall in no event be regarded as a guarantee of conditions or characteristics ("Beschaffheitsgarantie").

With respect to any examples, hints or any typical values stated herein and/or any information regarding the application of the product, Infineon Technologies hereby disclaims any and all warranties and liabilities of any kind, including without limitation warranties of non-infringement of intellectual property rights of any third party.

In addition, any information given in this document is subject to customer's compliance with its obligations stated in this document and any applicable legal requirements, norms and standards concerning customer's products and any use of the product of Infineon Technologies in customer's applications.

The data contained in this document is exclusively intended for technically trained staff. It is the responsibility of customer's technical departments to evaluate the suitability of the product for the intended application and the completeness of the product information given in this document with respect to such application.

For further information on the product, technology, delivery terms and conditions and prices please contact your nearest Infineon Technologies office (www.infineon.com).

WARNINGS

Due to technical requirements products may contain dangerous substances. For information on the types in question please contact your nearest Infineon Technologies office.

Except as otherwise explicitly approved by Infineon Technologies in a written document signed by authorized representatives of Infineon Technologies, Infineon Technologies' products may not be used in any applications where a failure of the product or any consequences of the use thereof can reasonably be expected to result in personal injury.

Mouser Electronics

Authorized Distributor

Click to View Pricing, Inventory, Delivery & Lifecycle Information:

[Infineon:](#)

[IRFI4020H-117P](#) [IRFI4020H-117PXKMA1](#)