

Final datasheet

TRENCHSTOP™ IGBT 7 PR7 Reverse Conducting IGBT for boost PFC stage with improved EMI characteristics offering the best-in-class performance for high power and high switching frequency applications

Features

- $V_{CE} = 670\text{ V}$
- $I_C = 70\text{ A}$
- Pin-to-pin creepage distance > 4.8 mm
- Pin-to-pin clearance distance > 3.4 mm
- Optimized monolithic diode for PFC applications
- Improved EMI behavior with lower dv/dt
- Very low $V_{CEsat} = 1.4\text{ V}$ (typ.) at 25°C
- Stable temperature behavior
- Low temperature dependence of V_{CEsat} and E_{sw}
- 2 kV ESD HBM compliant
- Easy parallel switching capability based on positive temperature coefficient of V_{CEsat}
- Product spectrum and PSpice Models: <http://www.infineon.com/igbt/>

Potential applications

- Residential Aircon / Commercial Aircon
- Residential HVAC / Commercial HVAC

Product validation

- Qualified for industrial applications according to the relevant tests of JEDEC47/20/22

Description

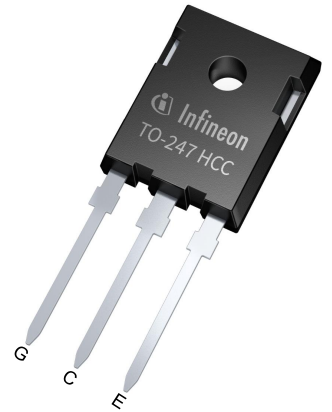
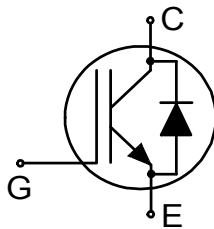

Type	Package	Marking
IKWH70N67PR7	PG-TO247-3-U04	H70EPR7

Table of contents

	Description	1
	Features	1
	Potential applications	1
	Product validation	1
	Table of contents	2
1	Package	3
2	IGBT	3
3	Diode	5
4	Characteristics diagrams	6
5	Package outlines	11
6	Testing conditions	12
	Revision history	13
	Disclaimer	14

1 Package

1 Package

Table 1 Characteristic values

Parameter	Symbol	Note or test condition	Values			Unit
			Min.	Typ.	Max.	
Internal emitter inductance measured 5 mm (0.197 in.) from case	L_E			13		nH
Storage temperature	T_{stg}		-55		150	°C
Soldering temperature	T_{sold}	wave soldering 1.6 mm (0.063 in.) from case for 10 s			260	°C
Mounting torque	M	M3 screw, Maximum of mounting processes: 3			0.6	Nm
Thermal resistance, junction-ambient	$R_{th(j-a)}$				40	K/W
IGBT thermal resistance, junction-case	$R_{th(j-c)}$			0.48	0.62	K/W

2 IGBT

Table 2 Maximum rated values

Parameter	Symbol	Note or test condition	Values	Unit
Collector-emitter voltage	V_{CE}	$T_{vj} \geq 25\text{ °C}$	670	V
DC collector current, limited by T_{vjmax}	I_C	$T_c = 25\text{ °C}$	140	A
		$T_c = 100\text{ °C}$	85	
Pulsed collector current, t_p limited by T_{vjmax}	I_{Cpulse}		210	A
Turn-off safe operating area		$V_{CE} \leq 670\text{ V}, T_{vj} \leq 175\text{ °C}$	210	A
Gate-emitter voltage	V_{GE}		± 20	V
Transient gate-emitter voltage	V_{GE}	$t_p \leq 0.5\text{ }\mu\text{s}, D < 0.001$	± 30	V
Power dissipation	P_{tot}	$T_c = 25\text{ °C}$	313	W
		$T_c = 100\text{ °C}$	156	

Table 3 Characteristic values

Parameter	Symbol	Note or test condition	Values			Unit
			Min.	Typ.	Max.	
Collector-emitter saturation voltage	V_{CEsat}	$I_C = 70\text{ A}, V_{GE} = 15\text{ V}$	$T_{vj} = 25\text{ °C}$	1.4	1.75	V
			$T_{vj} = 175\text{ °C}$	1.7		

(table continues...)

Table 3 (continued) Characteristic values

Parameter	Symbol	Note or test condition	Values			Unit
			Min.	Typ.	Max.	
Gate-emitter threshold voltage	V_{GEth}	$I_C = 0.4 \text{ mA}, V_{CE} = V_{GE}$	3.2	3.95	4.8	V
Zero gate-voltage collector current	I_{CES}	$V_{CE} = 670 \text{ V}, V_{GE} = 0 \text{ V}$	$T_{vj} = 25 \text{ }^\circ\text{C}$		40	mA
			$T_{vj} = 175 \text{ }^\circ\text{C}$		0.5	mA
Gate-emitter leakage current	I_{GES}	$V_{CE} = 0 \text{ V}, V_{GE} = 20 \text{ V}$			100	nA
Transconductance	g_{fs}	$I_C = 70 \text{ A}, V_{CE} = 20 \text{ V}$		109		S
Input capacitance	C_{ies}	$V_{CE} = 25 \text{ V}, V_{GE} = 0 \text{ V}, f = 100 \text{ kHz}$		3860		pF
Output capacitance	C_{oes}	$V_{CE} = 25 \text{ V}, V_{GE} = 0 \text{ V}, f = 100 \text{ kHz}$		49.4		pF
Reverse transfer capacitance	C_{res}	$V_{CE} = 25 \text{ V}, V_{GE} = 0 \text{ V}, f = 100 \text{ kHz}$		19.6		pF
Gate charge	Q_G	$V_{CC} = 520 \text{ V}, I_C = 70 \text{ A}, V_{GE} = 15 \text{ V}$		181		nC
Turn-on delay time	$t_{d(on)}$	$V_{CC} = 400 \text{ V}, V_{GE} = 0/15 \text{ V}, R_{G(on)} = 9.8 \text{ } \Omega, R_{G(off)} = 9.8 \text{ } \Omega$	$T_{vj} = 25 \text{ }^\circ\text{C}, I_C = 70 \text{ A}$		22	ns
			$T_{vj} = 175 \text{ }^\circ\text{C}, I_C = 70 \text{ A}$		20	
Rise time (inductive load)	t_r	$V_{CC} = 400 \text{ V}, V_{GE} = 0/15 \text{ V}, R_{G(on)} = 9.8 \text{ } \Omega$	$T_{vj} = 25 \text{ }^\circ\text{C}, I_C = 70 \text{ A}$		30	ns
			$T_{vj} = 175 \text{ }^\circ\text{C}, I_C = 70 \text{ A}$		28	
Turn-off delay time	$t_{d(off)}$	$V_{CC} = 400 \text{ V}, V_{GE} = 0/15 \text{ V}, R_{G(on)} = 9.8 \text{ } \Omega$	$T_{vj} = 25 \text{ }^\circ\text{C}, I_C = 70 \text{ A}$		246	ns
			$T_{vj} = 175 \text{ }^\circ\text{C}, I_C = 70 \text{ A}$		274	
Fall time (inductive load)	t_f	$V_{CC} = 400 \text{ V}, V_{GE} = 0/15 \text{ V}, R_{G(on)} = 9.8 \text{ } \Omega$	$T_{vj} = 25 \text{ }^\circ\text{C}, I_C = 70 \text{ A}$		40	ns
			$T_{vj} = 175 \text{ }^\circ\text{C}, I_C = 70 \text{ A}$		32	
Turn-on energy	E_{on}	$V_{CC} = 400 \text{ V}, V_{GE} = 0/15 \text{ V}, R_{G(on)} = 9.8 \text{ } \Omega$	$T_{vj} = 25 \text{ }^\circ\text{C}, I_C = 70 \text{ A}$		1.58	mJ
			$T_{vj} = 175 \text{ }^\circ\text{C}, I_C = 70 \text{ A}$		2.13	
Turn-off energy	E_{off}	$V_{CC} = 400 \text{ V}, V_{GE} = 0/15 \text{ V}, R_{G(on)} = 9.8 \text{ } \Omega$	$T_{vj} = 25 \text{ }^\circ\text{C}, I_C = 70 \text{ A}$		1.14	mJ
			$T_{vj} = 175 \text{ }^\circ\text{C}, I_C = 70 \text{ A}$		1.14	

(table continues...)

Table 3 (continued) Characteristic values

Parameter	Symbol	Note or test condition	Values			Unit	
			Min.	Typ.	Max.		
Total switching energy	E_{ts}	$V_{CC} = 400\text{ V}$, $V_{GE} = 0/15\text{ V}$, $R_{G(on)} = 9.8\ \Omega$	$T_{vj} = 25\text{ °C}$, $I_C = 70\text{ A}$		2.72		mJ
			$T_{vj} = 175\text{ °C}$, $I_C = 70\text{ A}$		3.27		
Operating junction temperature	T_{vj}		-40		175	°C	

3 Diode

Table 4 Maximum rated values

Parameter	Symbol	Note or test condition	Values	Unit
Repetitive peak reverse voltage	V_{RRM}	$T_{vj} \geq 25\text{ °C}$	670	V
Diode pulsed current, t_p limited by T_{vjmax}	I_{Fpulse}		5	A

Table 5 Characteristic values

Parameter	Symbol	Note or test condition	Values			Unit
			Min.	Typ.	Max.	
Operating junction temperature	T_{vj}		-40		175	°C

Note: For optimum lifetime and reliability, Infineon recommends operating conditions that do not exceed 80% of the maximum ratings stated in this datasheet.

Electrical Characteristic, at $T_{vj} = 25\text{ °C}$, unless otherwise specified.

Dynamic test circuit, parasitic inductance $L_\sigma = 30\text{ nH}$, parasitic capacitor $C_\sigma = 23\text{ pF}$ from Fig. C.

2nd device for EC7 Diode = IDWD75E65E7

4 Characteristics diagrams

Power dissipation as a function of case temperature

$P_{tot} = f(T_c)$
 $T_{vj} \leq 175\text{ °C}$

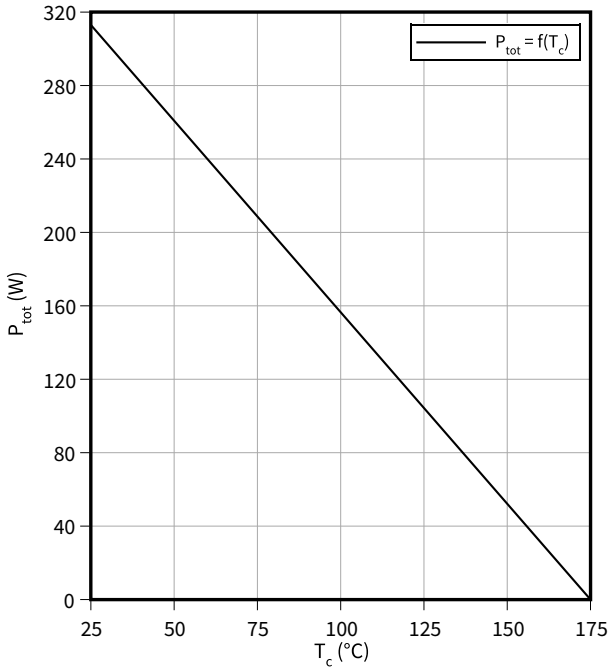

Collector current as a function of case temperature

$I_C = f(T_c)$
 $T_{vj} \leq 175\text{ °C}, V_{GE} \geq 15\text{ V}$

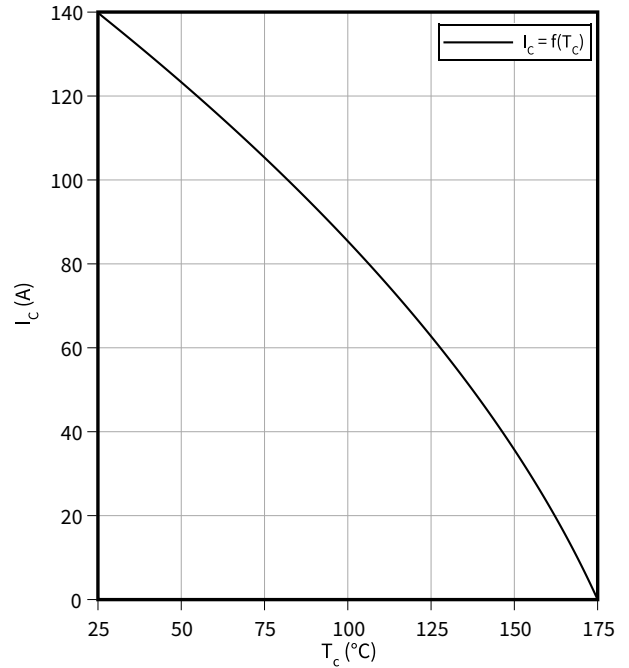

Typical output characteristic

$I_C = f(V_{CE})$
 $T_{vj} = 25\text{ °C}$

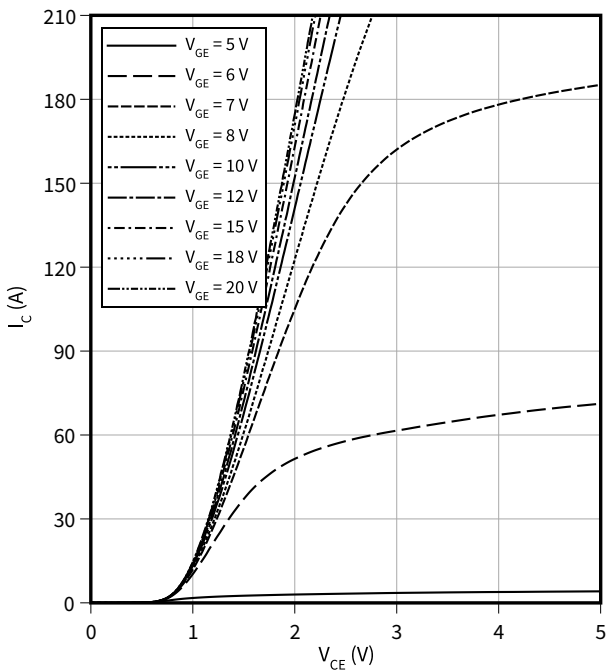

Typical output characteristic

$I_C = f(V_{CE})$
 $T_{vj} = 175\text{ °C}$

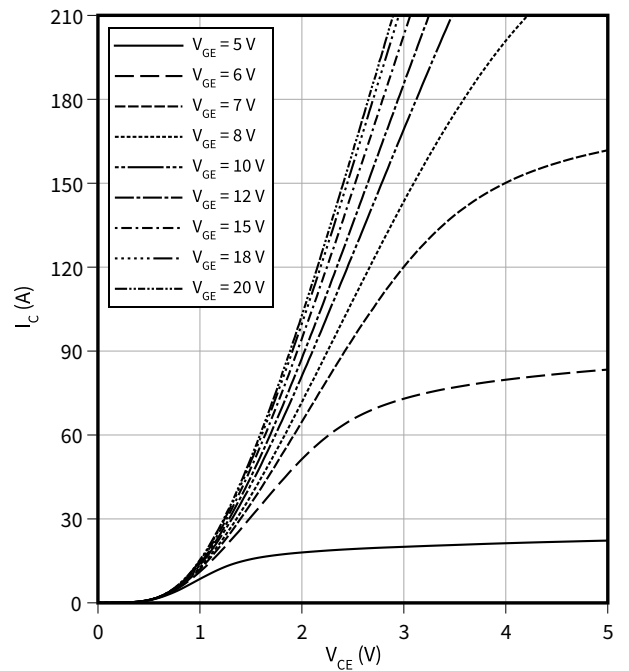

4 Characteristics diagrams

Typical transfer characteristic

$I_C = f(V_{GE})$

$V_{CE} = 20\text{ V}$

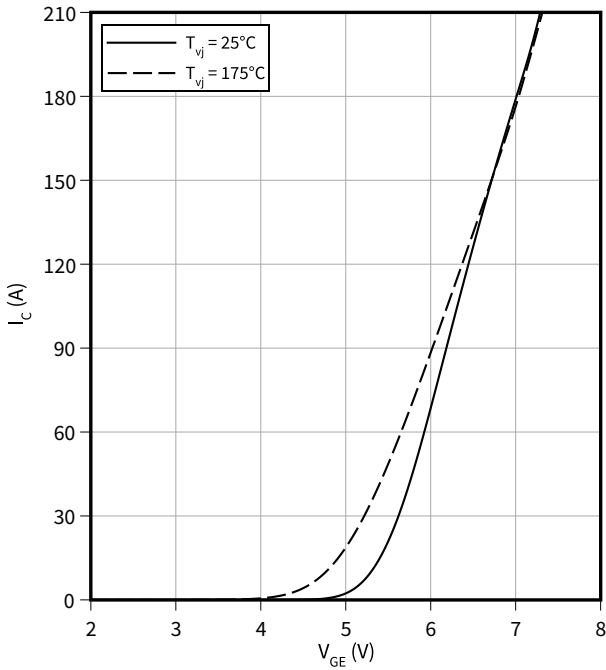

Typical collector-emitter saturation voltage as a function of junction temperature

$V_{CEsat} = f(T_{vj})$

$V_{GE} = 15\text{ V}$

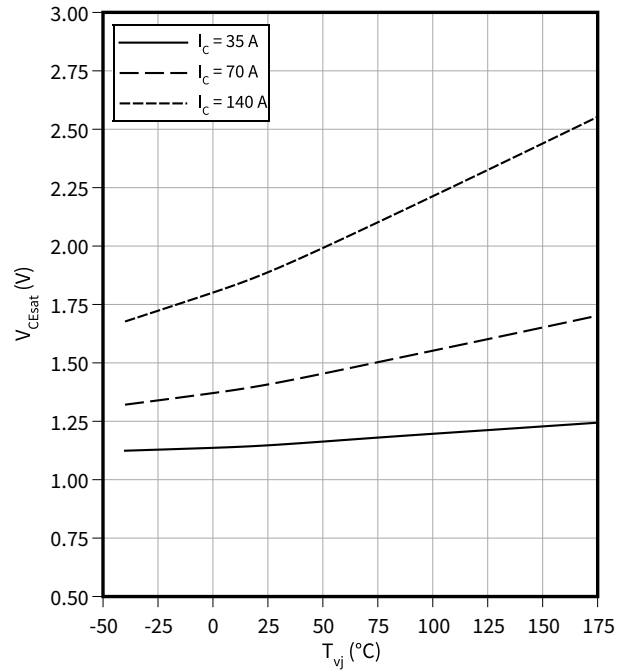

Gate-emitter threshold voltage as a function of junction temperature

$V_{GEth} = f(T_{vj})$

$I_C = 0.2\text{ mA}$

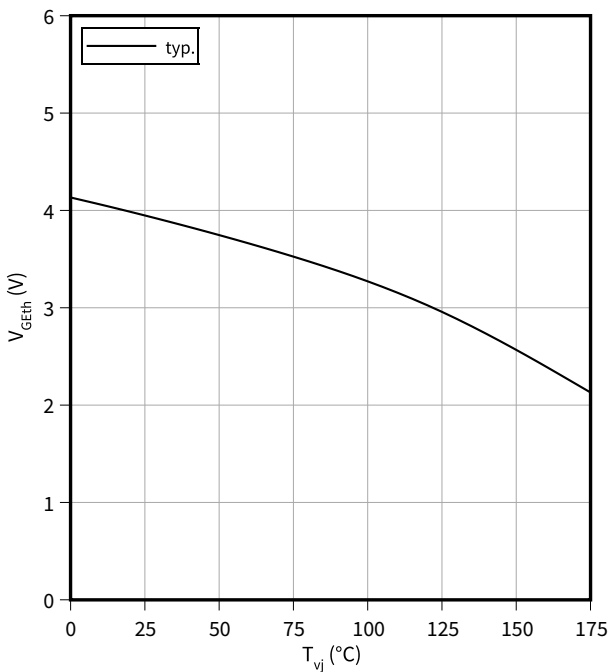

Typical switching times as a function of collector current

$t = f(I_C)$

$V_{CC} = 400\text{ V}, T_{vj} = 175^\circ\text{C}, V_{GE} = 0/15\text{ V}, R_G = 9.8\ \Omega$

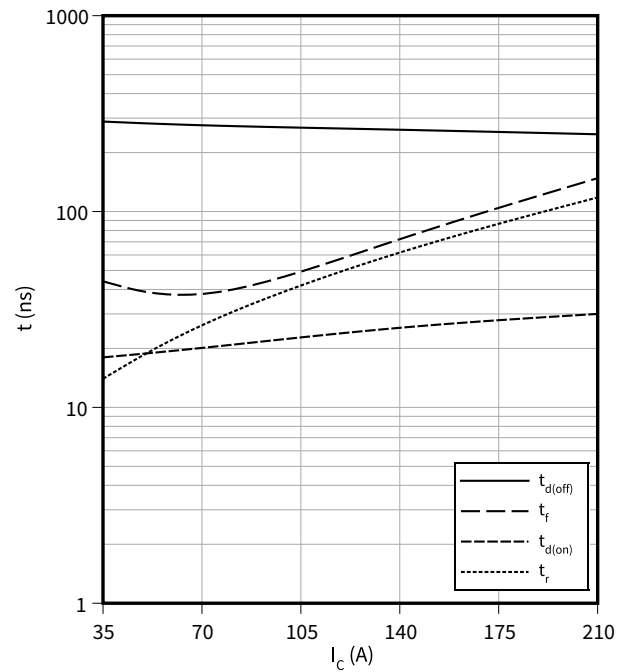

4 Characteristics diagrams

Typical switching times as a function of gate resistor

$t = f(R_G)$

$I_C = 70 \text{ A}, V_{CC} = 400 \text{ V}, T_{vj} = 175 \text{ }^\circ\text{C}, V_{GE} = 0/15 \text{ V}$

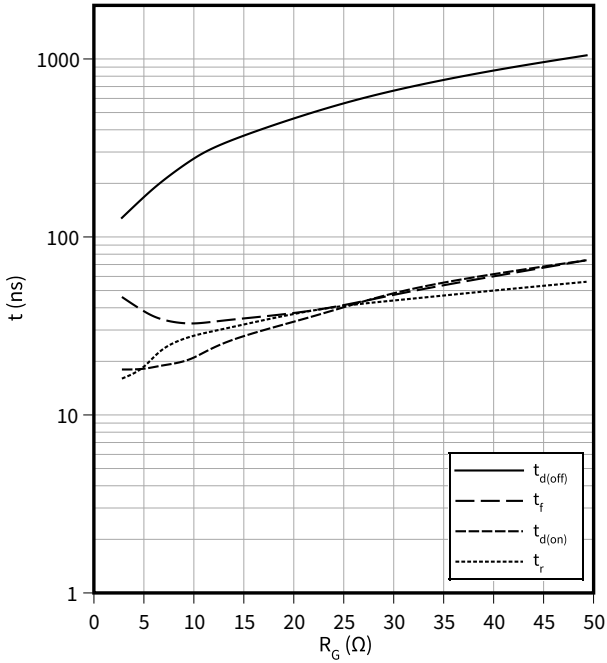

Typical switching times as a function of junction temperature

$t = f(T_{vj})$

$I_C = 70 \text{ A}, V_{CC} = 400 \text{ V}, V_{GE} = 0/15 \text{ V}, R_G = 9.8 \text{ } \Omega$

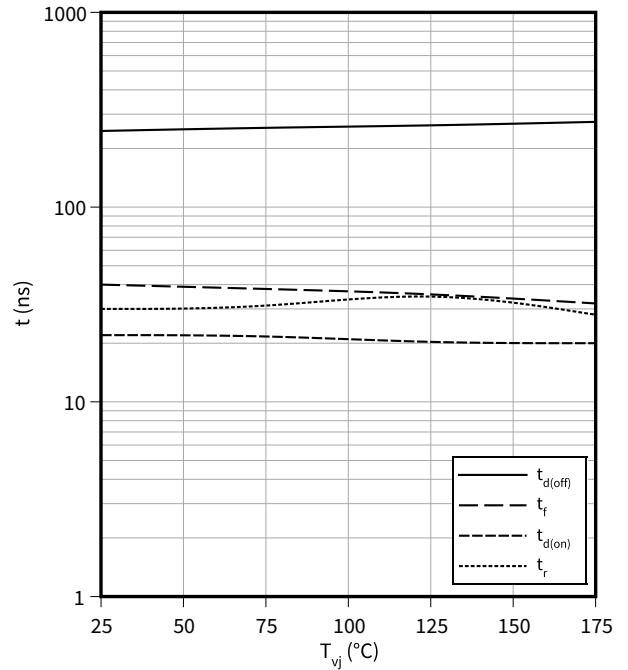

Typical switching energy losses as a function of collector current

$E = f(I_C)$

$V_{CC} = 400 \text{ V}, T_{vj} = 175 \text{ }^\circ\text{C}, V_{GE} = 0/15 \text{ V}, R_G = 9.8 \text{ } \Omega$

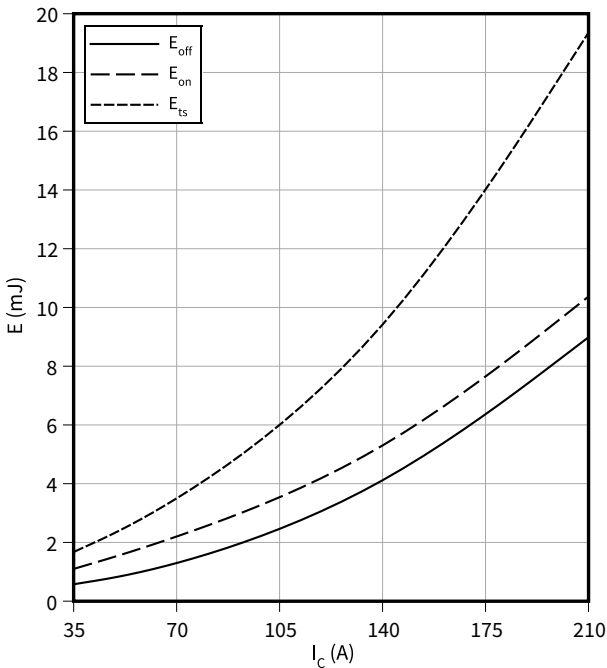

Typical switching energy losses as a function of gate resistor

$E = f(R_G)$

$I_C = 70 \text{ A}, V_{CC} = 400 \text{ V}, T_{vj} = 175 \text{ }^\circ\text{C}, V_{GE} = 0/15 \text{ V}$

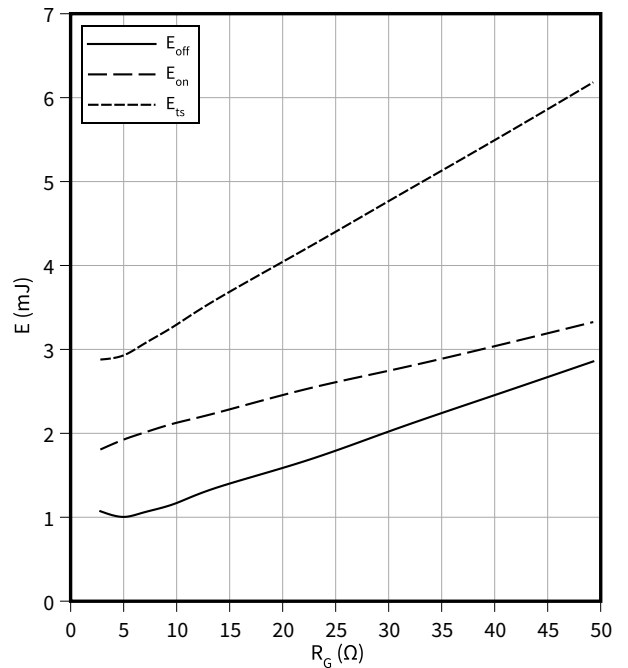

4 Characteristics diagrams

Typical switching energy losses as a function of junction temperature

$E = f(T_{vj})$

$I_C = 70\text{ A}, V_{CC} = 400\text{ V}, V_{GE} = 0/15\text{ V}, R_G = 9.8\ \Omega$

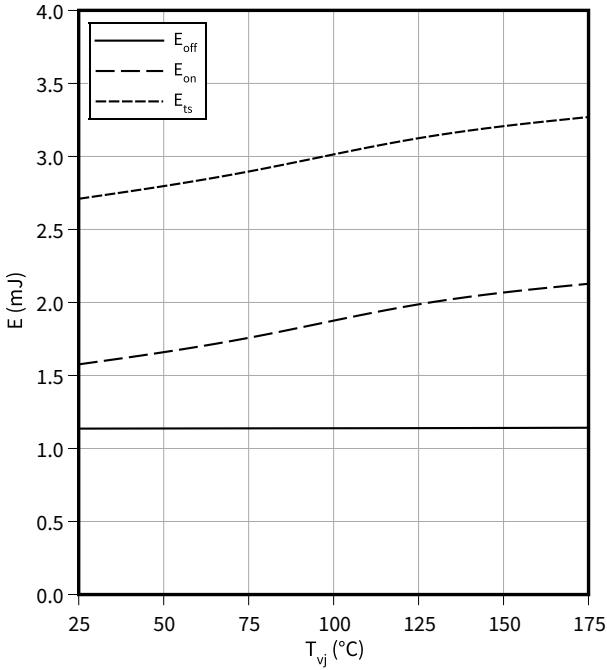

Typical switching energy losses as a function of collector emitter voltage

$E = f(V_{CE})$

$I_C = 70\text{ A}, T_{vj} = 175\text{ °C}, V_{GE} = 0/15\text{ V}, R_G = 9.8\ \Omega$

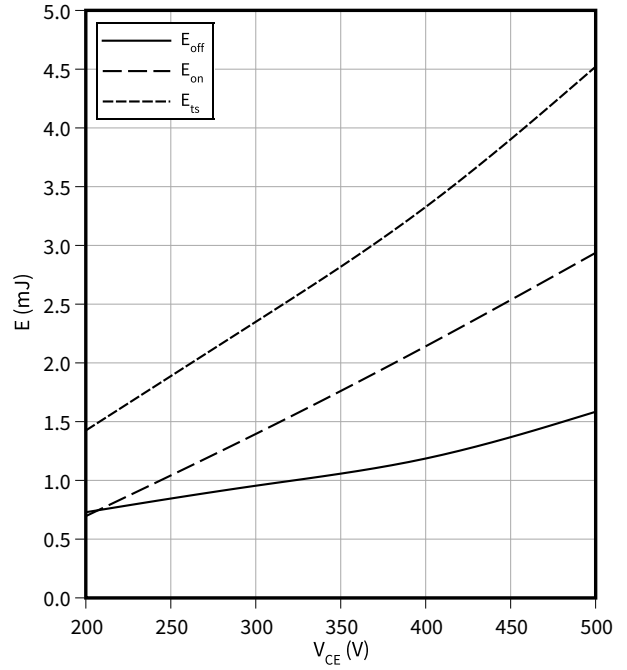

Typical gate charge

$V_{GE} = f(Q_G)$

$I_C = 70\text{ A}$

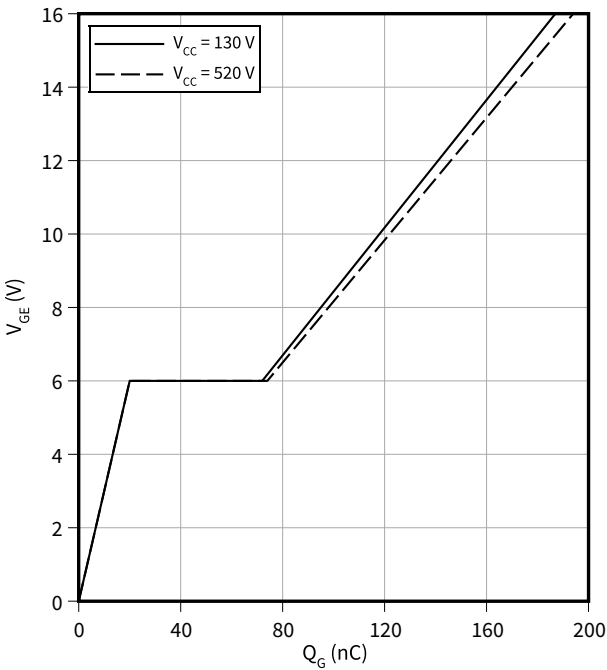

Typical capacitance as a function of collector-emitter voltage

$C = f(V_{CE})$

$f = 100\text{ kHz}, V_{GE} = 0\text{ V}$

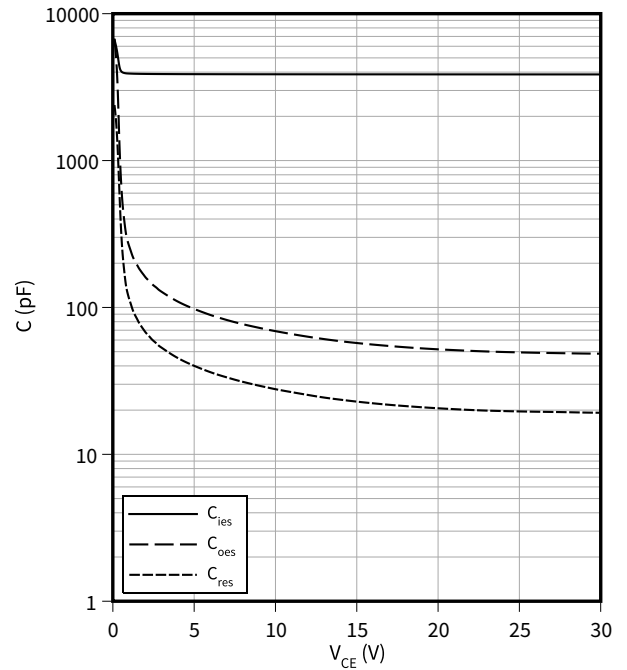

4 Characteristics diagrams

IGBT transient thermal impedance as a function of pulse width

$$Z_{th(j-c)} = f(t_p)$$

$$D = t_p/T$$

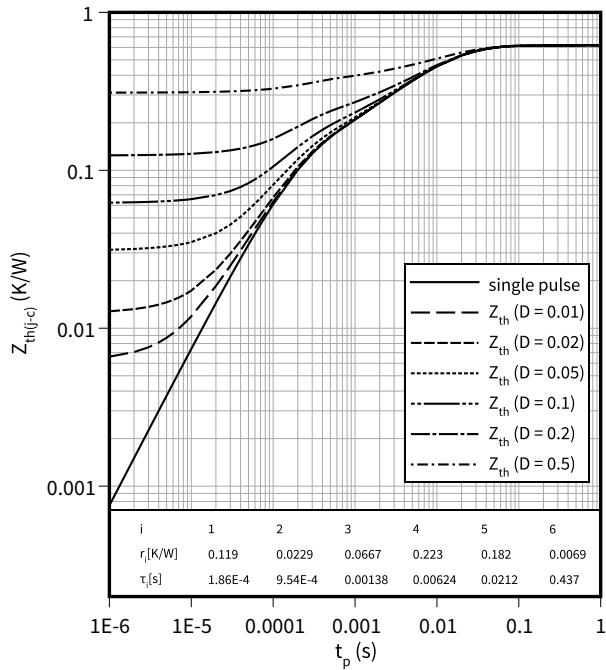

5 Package outlines

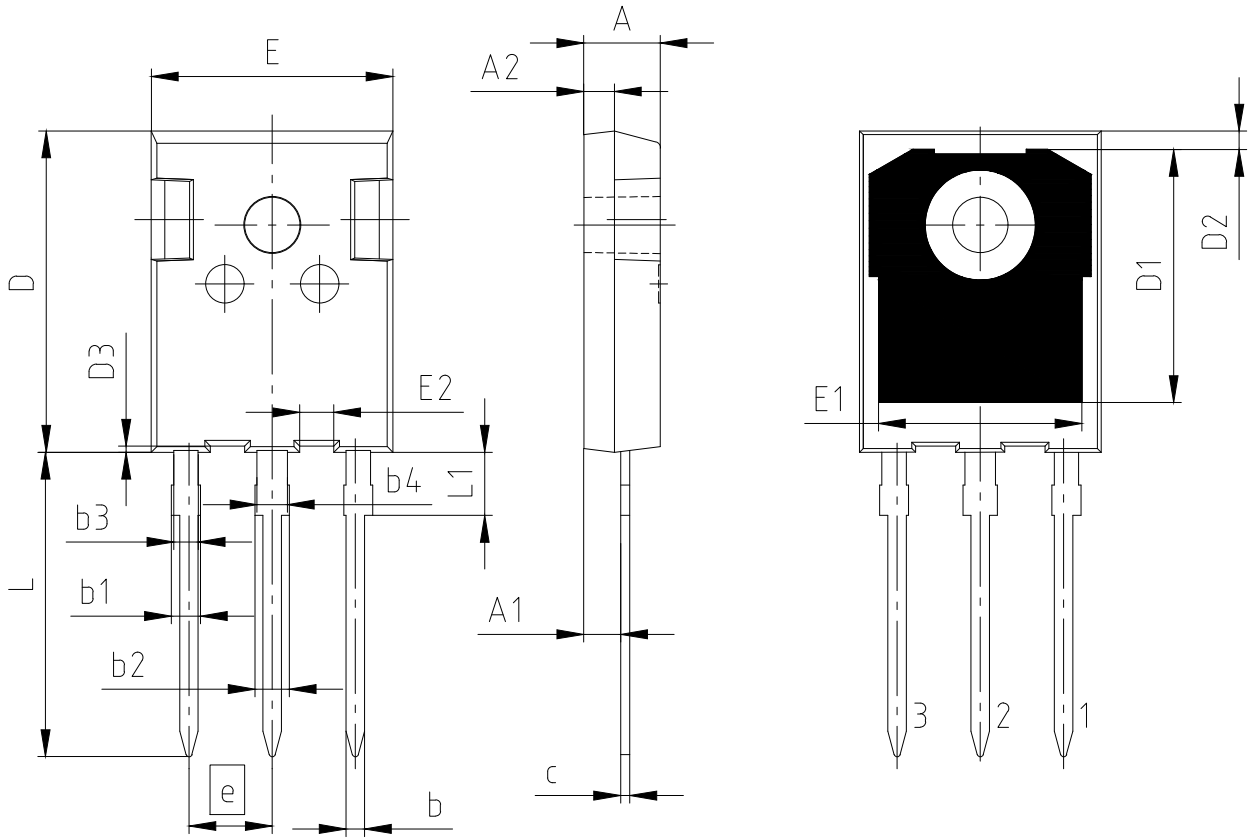

PACKAGE - GROUP NUMBER: PG-TO247-3-U04		
DIMENSIONS	MILLIMETERS	
	MIN.	MAX.
A	4.90	5.10
A1	2.31	2.51
A2	1.90	2.10
b	1.16	1.26
b1		1.90
b2		2.30
b3	1.55	1.65
b4	1.96	2.06
c	0.59	0.66
D	20.90	21.10
D1	16.25	16.85
D2	1.05	1.35
D3	0.55	0.65
E	15.70	15.90
E1	13.10	13.50
E2	2.14	2.34
e	5.44	
N	3	
L	19.80	20.10
L1	3.95	4.30

Figure 1

6 Testing conditions

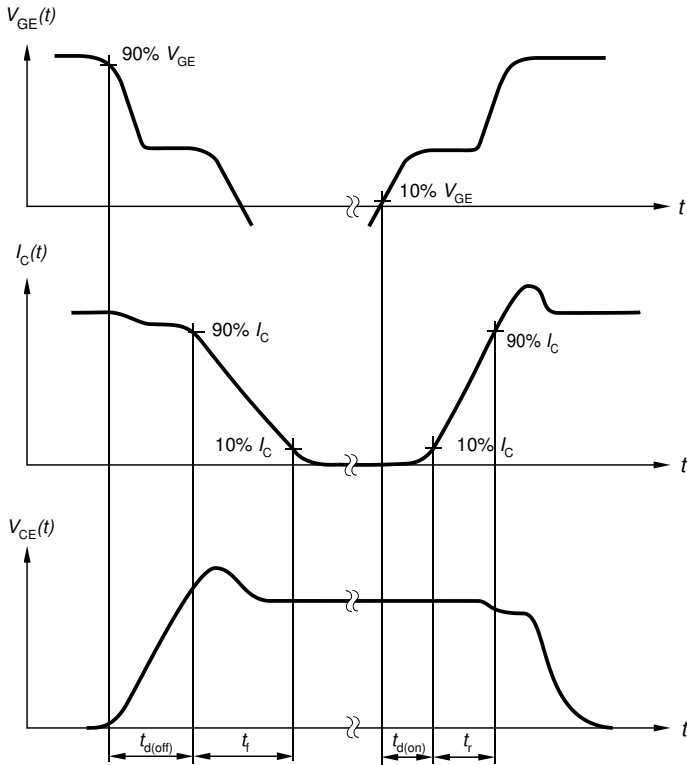

Figure A. Definition of switching times

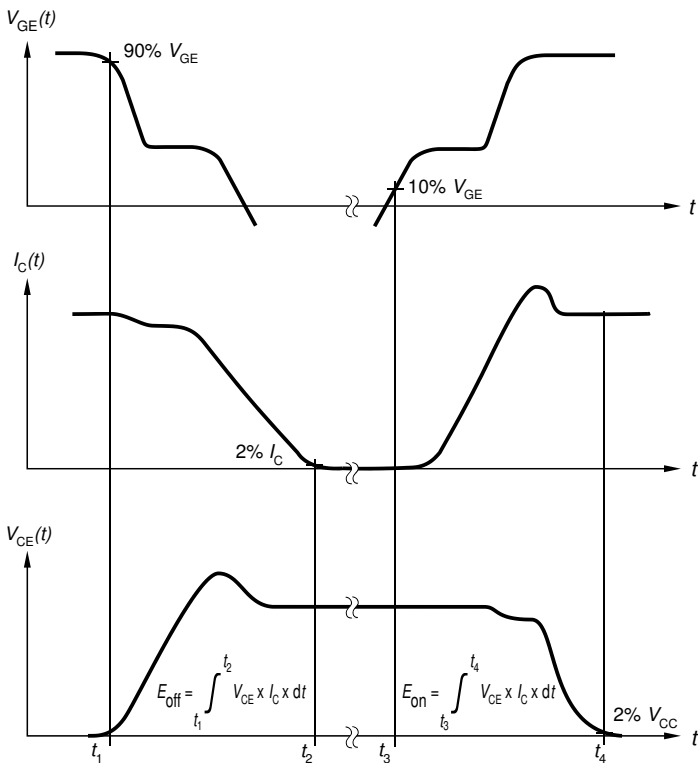

Figure B. Definition of switching losses

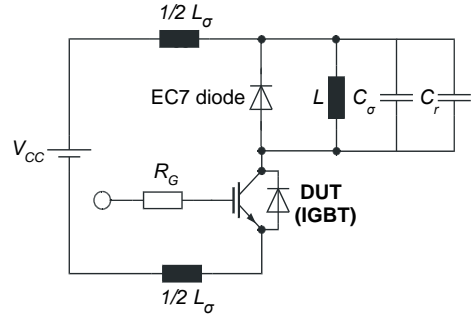

Figure C. Dynamic test circuit

Parasitic inductance L_{σ} ,
 parasitic capacitor C_{σ} ,
 relief capacitor C_r ,
 (only for ZVT switching)

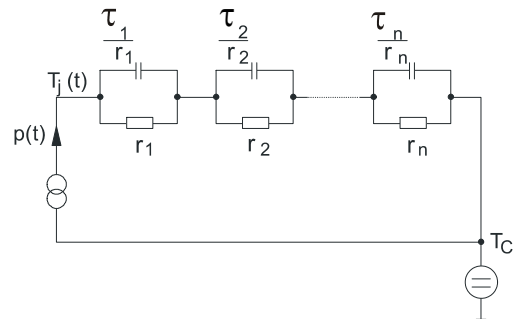

Figure D. Thermal equivalent circuit

Figure 2

Revision history

Document revision	Date of release	Description of changes
0.10	2024-08-13	Preliminary datasheet
1.00	2024-09-20	Final datasheet

Trademarks

All referenced product or service names and trademarks are the property of their respective owners.

Edition 2024-09-23

Published by

Infineon Technologies AG

81726 Munich, Germany

© 2024 Infineon Technologies AG

All Rights Reserved.

Do you have a question about any aspect of this document?

Email: erratum@infineon.com

Document reference

IFX-ABJ853-002

Important notice

The information given in this document shall in no event be regarded as a guarantee of conditions or characteristics ("Beschaffheitsgarantie").

With respect to any examples, hints or any typical values stated herein and/or any information regarding the application of the product, Infineon Technologies hereby disclaims any and all warranties and liabilities of any kind, including without limitation warranties of non-infringement of intellectual property rights of any third party.

In addition, any information given in this document is subject to customer's compliance with its obligations stated in this document and any applicable legal requirements, norms and standards concerning customer's products and any use of the product of Infineon Technologies in customer's applications.

The data contained in this document is exclusively intended for technically trained staff. It is the responsibility of customer's technical departments to evaluate the suitability of the product for the intended application and the completeness of the product information given in this document with respect to such application.

Please note that this product is not qualified according to the AEC Q100 or AEC Q101 documents of the Automotive Electronics Council.

Warnings

Due to technical requirements products may contain dangerous substances. For information on the types in question please contact your nearest Infineon Technologies office.

Except as otherwise explicitly approved by Infineon Technologies in a written document signed by authorized representatives of Infineon Technologies, Infineon Technologies' products may not be used in any applications where a failure of the product or any consequences of the use thereof can reasonably be expected to result in personal injury.

Mouser Electronics

Authorized Distributor

Click to View Pricing, Inventory, Delivery & Lifecycle Information:

[Infineon:](#)

[IKWH70N67PR7XKSA1](#)