

**OptiMOS® Power-Transistor**
**Feature**

- N-Channel
- Enhancement mode
- Logic Level
- Green Product (RoHS Compliant)
- AEC Qualified

**Product Summary**

$V_{DS}$	55	V
$R_{DS(on)}$	33	m $\Omega$
$I_D$	5.2	A

SOT 223

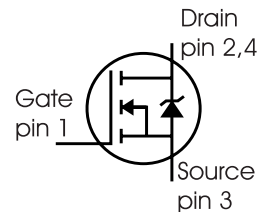
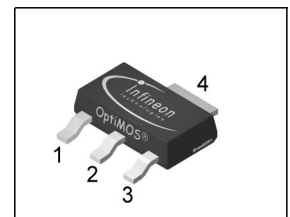

Type	Package	Ordering Code	Marking
BSP603S2L	SOT 223	On Request	2N603L

**Maximum Ratings**, at  $T_j = 25\text{ °C}$ , unless otherwise specified

Parameter	Symbol	Value	Unit
Continuous drain current $T_A=25\text{ °C}$ $T_A=70\text{ °C}$	$I_D$	5.2 4.1	A
Pulsed drain current $T_A=25\text{ °C}$	$I_{D\text{ puls}}$	21	
Gate source voltage	$V_{GS}$	$\pm 20$	V
Power dissipation $T_A=25\text{ °C}$	$P_{tot}$	1.8	W
Operating and storage temperature IEC climatic category; DIN IEC 68-1	$T_j, T_{stg}$	-55... +150 55/150/00	$\text{°C}$

**Thermal Characteristics**

Parameter	Symbol	Values			Unit
		min.	typ.	max.	
<b>Characteristics</b>					
Thermal resistance, junction - soldering point (Pin 4)	$R_{thJS}$	-	15	20	K/W
Thermal resistance, chip to ambient air:	$R_{thJA}$				
@ min. footprint		-	-	120	
@ 6 cm <sup>2</sup> cooling area <sup>1)</sup>		-	-	70	

**Electrical Characteristics**, at  $T_j = 25\text{ }^\circ\text{C}$ , unless otherwise specified

Parameter	Symbol	Values			Unit
		min.	typ.	max.	
<b>Static Characteristics</b>					
Drain-source breakdown voltage $V_{GS}=0V, I_D=1mA$	$V_{(BR)DSS}$	55	-	-	V
Gate threshold voltage, $V_{GS} = V_{DS}$ $I_D=50\mu A$	$V_{GS(th)}$	1.2	1.6	2	
Zero gate voltage drain current $V_{DS}=55V, V_{GS}=0V, T_j=25^\circ C$ $V_{DS}=55V, V_{GS}=0V, T_j=150^\circ C$	$I_{DSS}$	-	0.1	1	$\mu A$
		-	10	100	
Gate-source leakage current $V_{GS}=20V, V_{DS}=0V$	$I_{GSS}$	-	10	100	nA
Drain-source on-state resistance $V_{GS}=4.5V, I_D=2.6A$	$R_{DS(on)}$	-	27	40	m $\Omega$
Drain-source on-state resistance $V_{GS}=10V, I_D=2.6A$	$R_{DS(on)}$	-	23	33	

<sup>1)</sup>Device on 40mm\*40mm\*1.5mm epoxy PCB FR4 with 6cm<sup>2</sup> (one layer, 70  $\mu m$  thick) copper area for drain connection. PCB is vertical without blown air.

**Electrical Characteristics**

Parameter	Symbol	Conditions	Values			Unit
			min.	typ.	max.	

**Dynamic Characteristics**

Transconductance	$g_{fs}$	$V_{DS} \geq 2 \cdot I_D \cdot R_{DS(on)max}$ , $I_D = 5.2$	8.9	17.8	-	S
Input capacitance	$C_{iss}$	$V_{GS} = 0V$ , $V_{DS} = 25V$ , $f = 1MHz$	-	1034	1390	pF
Output capacitance	$C_{oss}$		-	244	325	
Reverse transfer capacitance	$C_{rss}$		-	75	110	
Turn-on delay time	$t_{d(on)}$	$V_{DD} = 30V$ , $V_{GS} = 4.5V$ , $I_D = 5.2A$ , $R_G = 5.6\Omega$	-	10.8	16	ns
Rise time	$t_r$	$V_{DD} = 30V$ , $V_{GS} = 4.5V$ , $I_D = 5.2mA$ , $R_G = 5.6\Omega$	-	16	24	
Turn-off delay time	$t_{d(off)}$		-	28	40	
Fall time	$t_f$		-	15	23	

**Gate Charge Characteristics**

Gate to source charge	$Q_{gs}$	$V_{DD} = 44V$ , $I_D = 5.2A$	-	3.5	4.6	nC
Gate to drain charge	$Q_{gd}$		-	10.6	16	
Gate charge total	$Q_g$	$V_{DD} = 44V$ , $I_D = 5.2A$ , $V_{GS} = 0$ to $10V$	-	31	42	
Gate plateau voltage	$V_{(plateau)}$	$V_{DD} = 44V$ , $I_D = 5.2A$	-	3	-	V

**Reverse Diode**

Inverse diode continuous forward current	$I_S$	$T_A = 25^\circ C$	-	-	5.2	A
Inv. diode direct current, pulsed	$I_{SM}$		-	-	21	
Inverse diode forward voltage	$V_{SD}$	$V_{GS} = 0V$ , $I_F = 5.2A$	-	0.8	1.1	V
Reverse recovery time	$t_{rr}$	$V_R = 30V$ , $I_F = I_S$ , $di_F/dt = 100A/\mu s$	-	46	58	ns
Reverse recovery charge	$Q_{rr}$		-	44	55	nC

### 1 Power dissipation

$$P_{\text{tot}} = f(T_C)$$

parameter:  $V_{GS} \geq 4 \text{ V}$

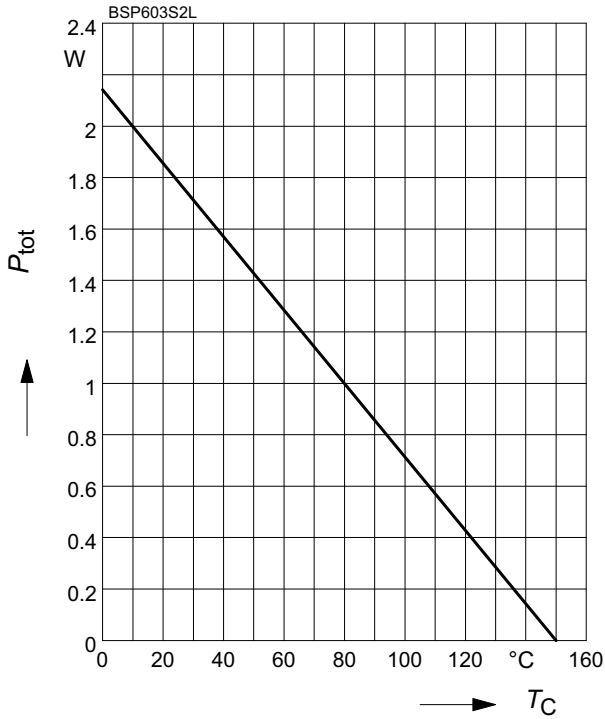

### 2 Drain current

$$I_D = f(T_C)$$

parameter:  $V_{GS} \geq 10 \text{ V}$

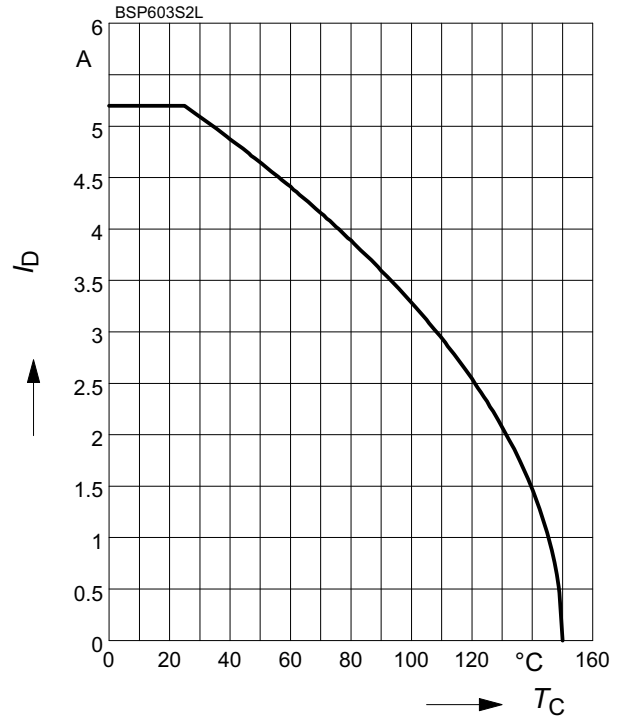

### 3 Safe operating area

$$I_D = f(V_{DS})$$

parameter:  $D = 0, T_C = \text{--}$

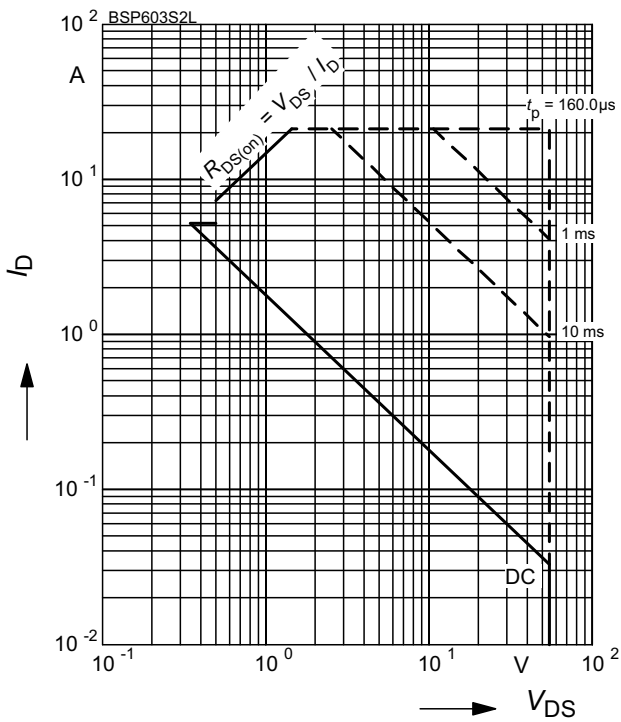

### 4 Max. transient thermal impedance

$$Z_{\text{thJC}} = f(t_p)$$

parameter:  $D = t_p/T$

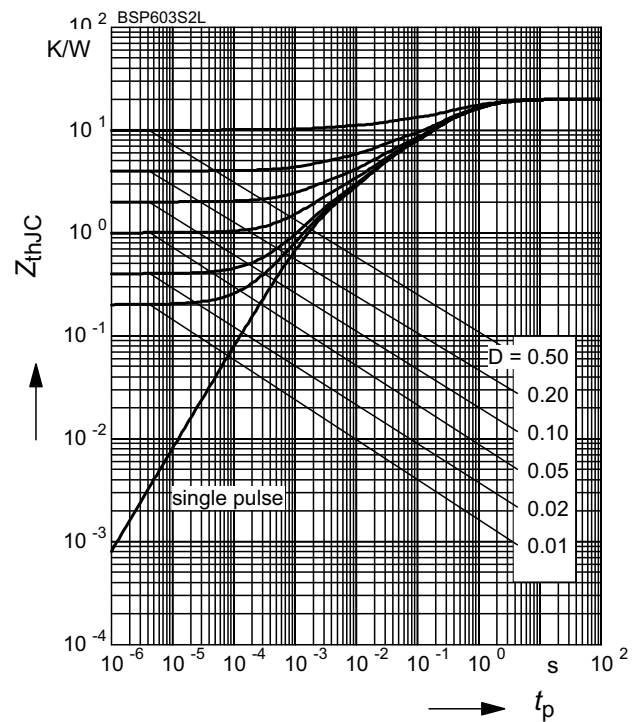

**5 Typ. output characteristic**

$I_D = f(V_{DS}); T_j = 25^\circ\text{C}$

parameter:  $t_p = 80 \mu\text{s}$

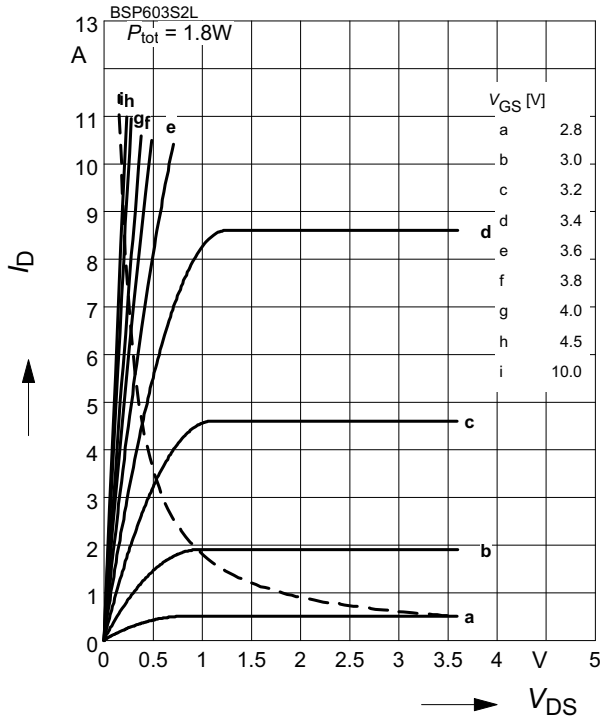

**6 Typ. drain-source on resistance**

$R_{DS(on)} = f(I_D)$

parameter:  $V_{GS}$

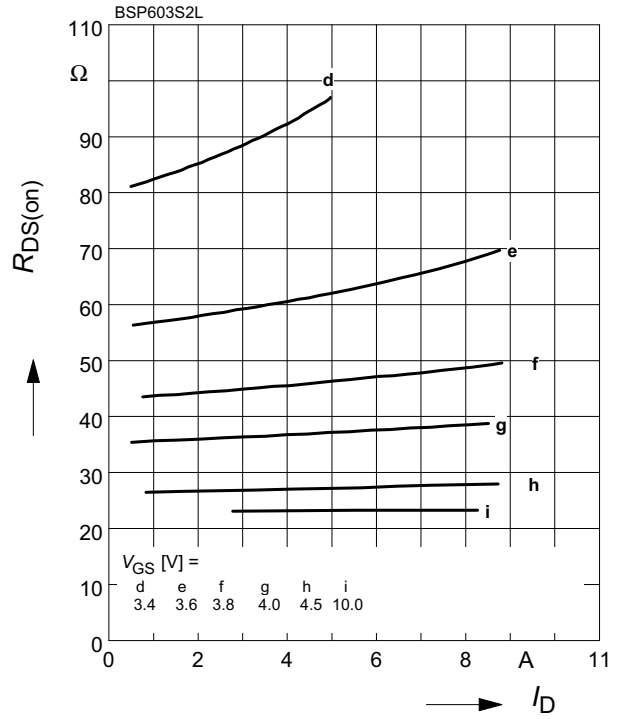

**7 Typ. transfer characteristics**

$I_D = f(V_{GS}); V_{DS} \geq 2 \times I_D \times R_{DS(on)max}$

parameter:  $t_p = 80 \mu\text{s}$

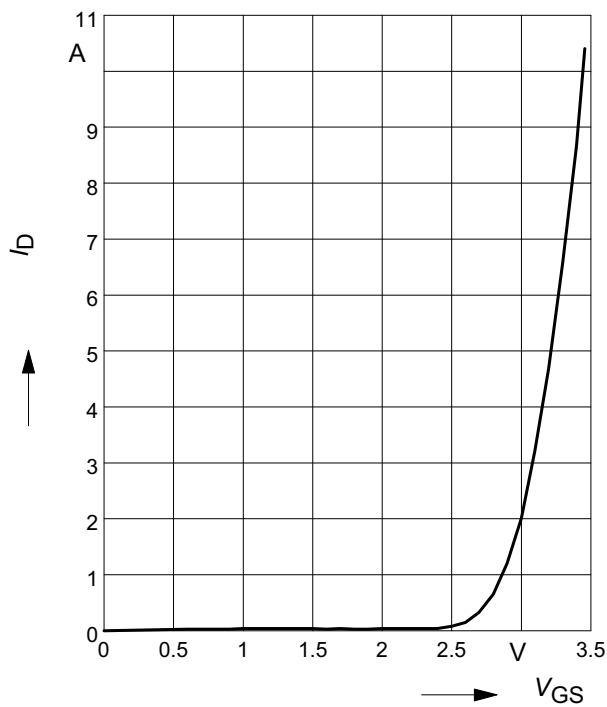

**8 Typ. forward transconductance**

$g_{fs} = f(I_D); T_j = 25^\circ\text{C}$

parameter:  $g_{fs}$

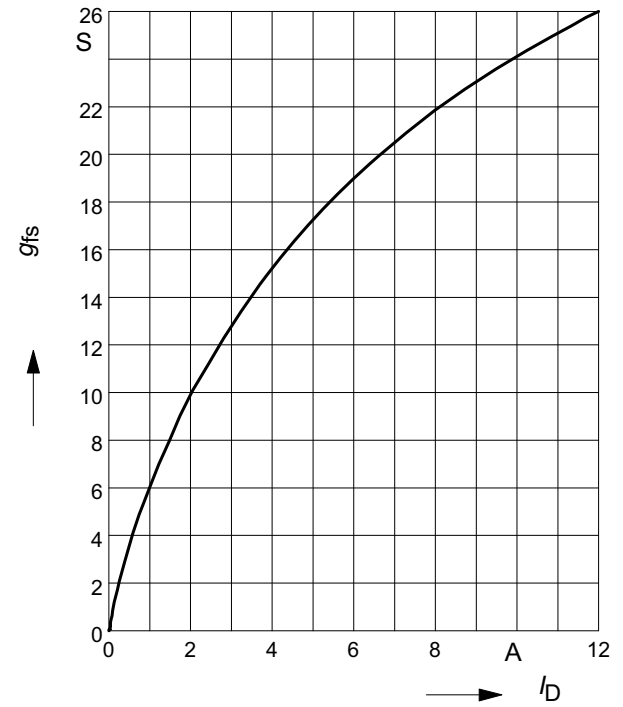

### 9 Drain-source on-state resistance

$$R_{DS(on)} = f(T_j)$$

parameter :  $I_D = 2.6 \text{ A}$ ,  $V_{GS} = 10 \text{ V}$

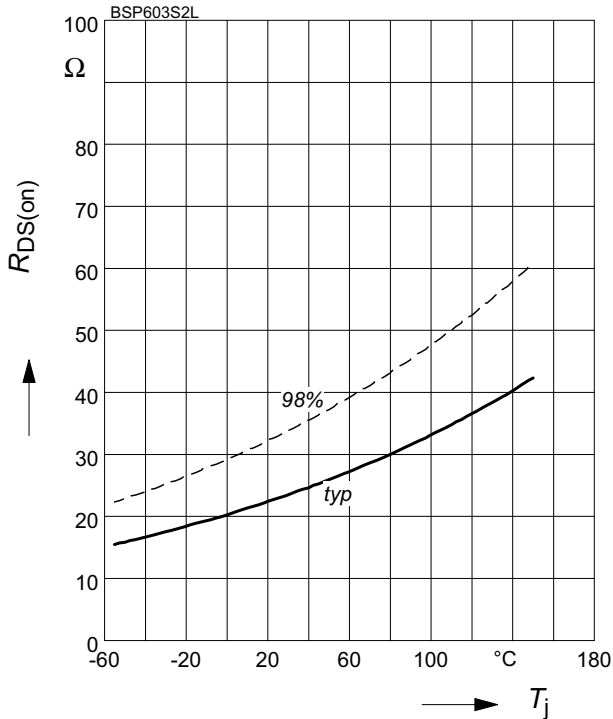

### 10 Typ. gate threshold voltage

$$V_{GS(th)} = f(T_j)$$

parameter:  $V_{GS} = V_{DS}$

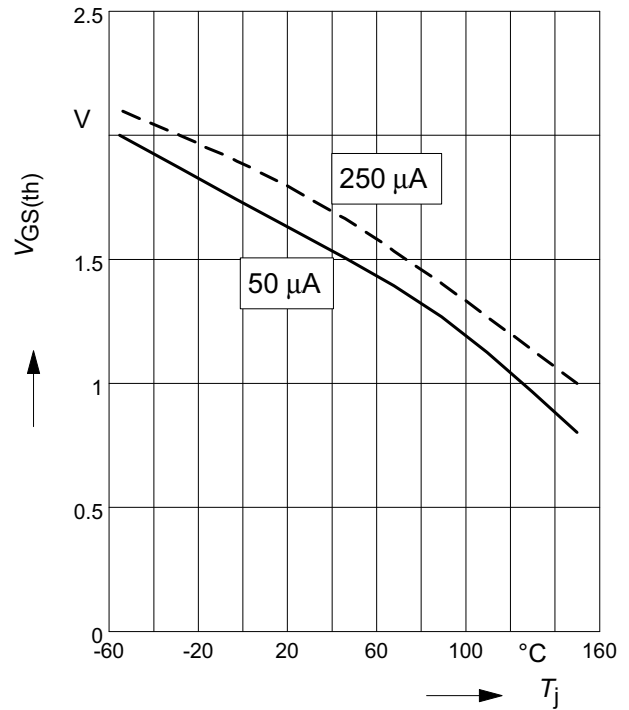

### 11 Typ. capacitances

$$C = f(V_{DS})$$

parameter:  $V_{GS}=0\text{V}$ ,  $f=1 \text{ MHz}$

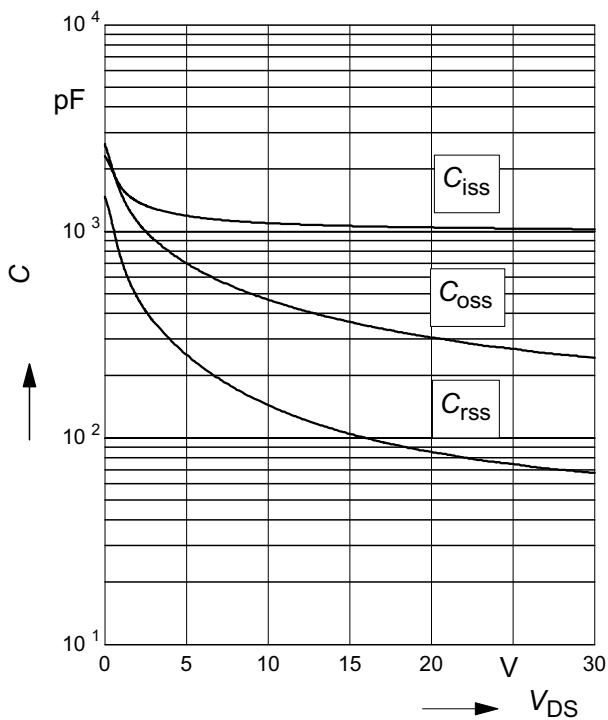

### 12 Forward character. of reverse diode

$$I_F = f(V_{SD})$$

parameter:  $T_j$ ,  $t_p = 80 \mu\text{s}$

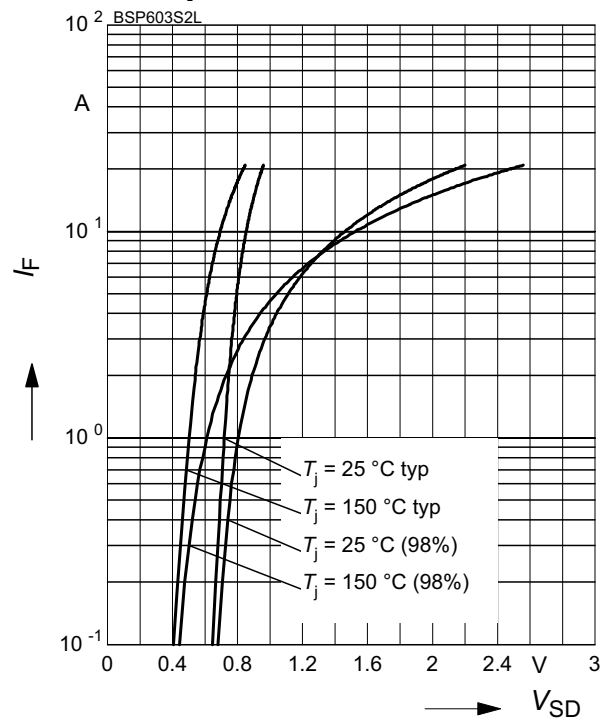

**13 Typ. gate charge**

$$V_{GS} = f(Q_{Gate})$$

parameter:  $I_D = 5.2 \text{ A pulsed}$

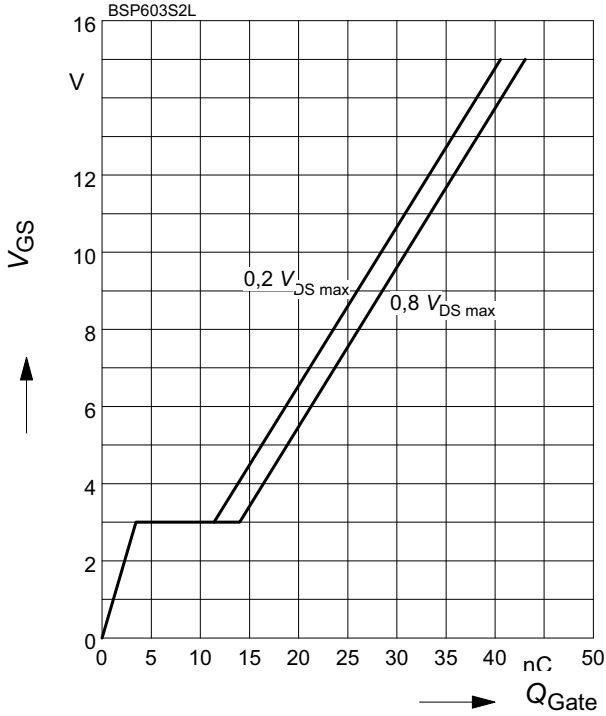

**14 Drain-source breakdown voltage**

$$V_{(BR)DSS} = f(T_j)$$

parameter:  $I_D = 10 \text{ mA}$

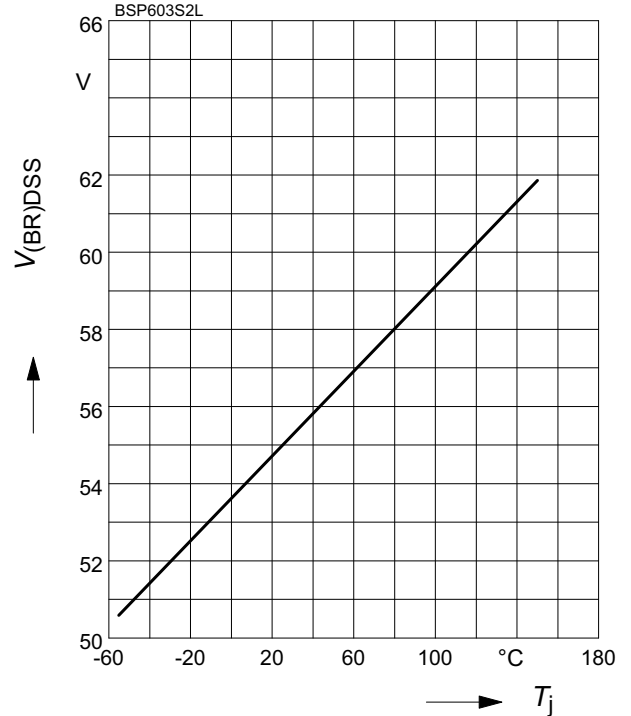

# 1 Package Outlines

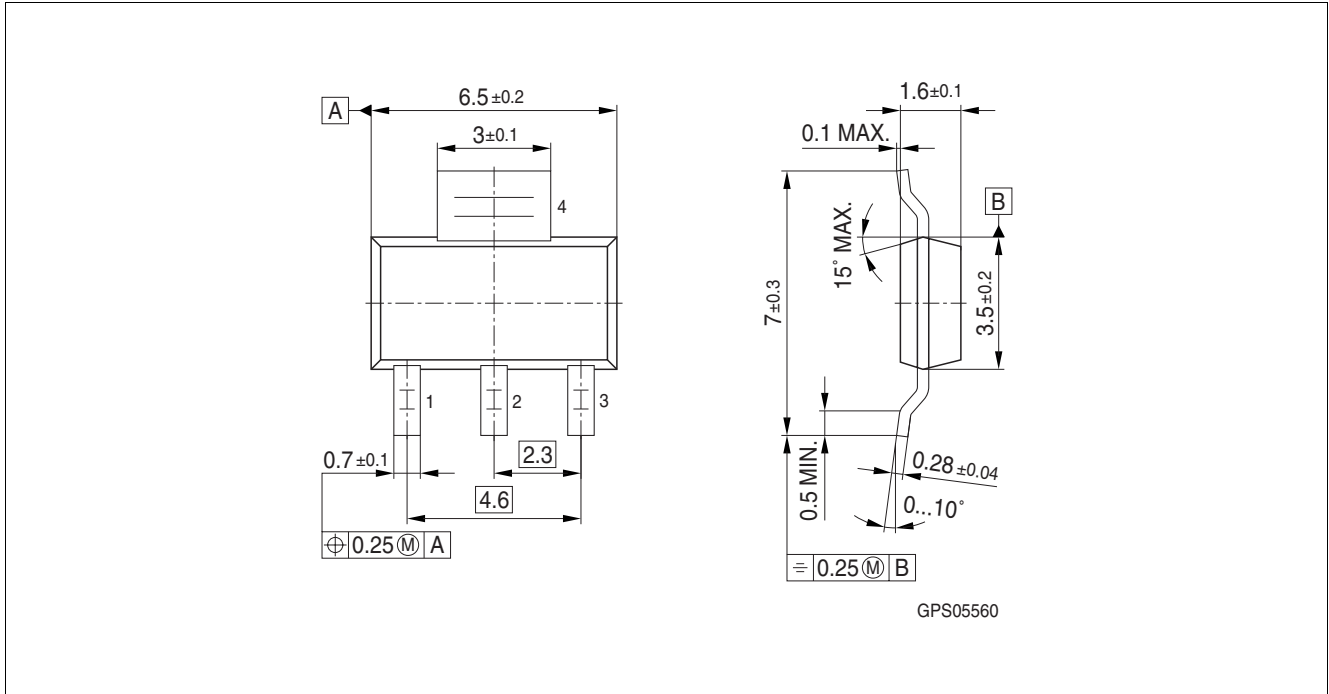

Figure 1 SOT 223

### Green Product (RoHS compliant)

To meet the world-wide customer requirements for environmentally friendly products and to be compliant with government regulations the device is available as a green product. Green products are RoHS-Compliant (i.e. Pb-free finish on leads and suitable for Pb-free soldering according to IPC/JEDEC J-STD-020).

For further information on alternative packages, please visit our website:  
<http://www.infineon.com/packages>.

Dimensions in mm



## 2 Revision History

Revision	Date	Changes
1.1	2008-05-27	Initial version of RoHS-compliant derivate of BSP603S2L Page 1: AEC certified statement added Page 1 and 8: added RoHS compliance statement and Green product feature Page 1 and 8: Package changed to RoHS compliant version Page 9-10: added Revision History, updated Legal Disclaimer

**Edition 2008-05-27**

**Published by  
Infineon Technologies AG  
81726 Munich, Germany**

**© 2008 Infineon Technologies AG  
All Rights Reserved.**

### **Legal Disclaimer**

The information given in this document shall in no event be regarded as a guarantee of conditions or characteristics. With respect to any examples or hints given herein, any typical values stated herein and/or any information regarding the application of the device, Infineon Technologies hereby disclaims any and all warranties and liabilities of any kind, including without limitation, warranties of non-infringement of intellectual property rights of any third party.

### **Information**

For further information on technology, delivery terms and conditions and prices, please contact the nearest Infineon Technologies Office ([www.infineon.com](http://www.infineon.com)).

### **Warnings**

Due to technical requirements, components may contain dangerous substances. For information on the types in question, please contact the nearest Infineon Technologies Office.

Infineon Technologies components may be used in life-support devices or systems only with the express written approval of Infineon Technologies, if a failure of such components can reasonably be expected to cause the failure of that life-support device or system or to affect the safety or effectiveness of that device or system. Life support devices or systems are intended to be implanted in the human body or to support and/or maintain and sustain and/or protect human life. If they fail, it is reasonable to assume that the health of the user or other persons may be endangered.

# Mouser Electronics

Authorized Distributor

Click to View Pricing, Inventory, Delivery & Lifecycle Information:

[Infineon:](#)

[BSP603S2L](#)