

BGB707L7ESD

General purpose LNA MMIC with integrated ESD protection and active biasing



Product description

The BGB707L7ESD is a high performance low noise amplifier (LNA) MMIC based on Infineon's silicon germanium carbon (SiGe:C) bipolar technology.



Feature list

- Minimum noise figure $NF_{min} = 0.6$ dB at 2.4 GHz, 3 V, 3 mA
- Supply voltage $V_{CC} = 1.8$ V to 4.0 V at $T_A = 25$ °C
- Integrated ESD protection: 2 kV HBM at all pins

Product validation

Qualified for industrial applications according to the relevant tests of JEDEC47/20/22.

Potential applications

- Satellite navigation systems (e.g. GPS, GLONASS, BeiDou, Galileo)
- Wireless communications: WLAN 2.4 GHz and 5-6 GHz bands, broadband LTE or WiMAX LNA
- ISM applications like RKE and smart meter, as well as for emerging wireless applications such as DVB-Terrestrial

Device information

Table 1 Part information

Product name / Ordering code	Package	Pin configuration				Marking	Pieces / Reel
BGB707L7ESD / BGB707L7ESDE6327XTSA1	TSLP-7-1	1 = V_{CC}	2 = V_{Bias}	3 = RF_{in}	4 = RF_{out}	AZ	7500
		5 = V_{Ctrl}	6 = Current adjust	7 = Ground			

Attention: ESD (Electrostatic discharge) sensitive device, observe handling precautions

Functional block diagram

Functional block diagram

This functional block diagram explains how the BGB707L7ESD is used. The RF power on/off function is controlled by applying V_{Ctrl} . By using an external resistor R_{ext} , the pre-set current of 2.1 mA (when R_{ext} is omitted) can be increased. Base V_B and collector V_C voltages are applied to the respective pins RF_{in} and RF_{out} by external inductors L_B and L_C .

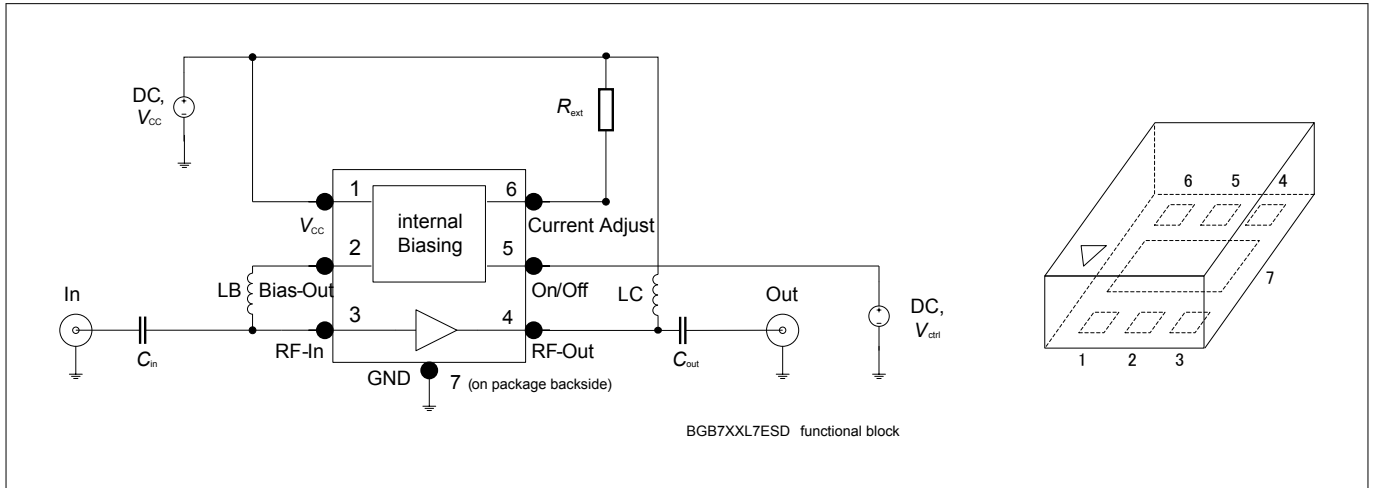

Figure 1 Functional block diagram

Table of contents

Table of contents

	Product description	1
	Feature list	1
	Product validation	1
	Potential applications	1
	Device information	1
	Functional block diagram	2
	Table of contents	3
1	Operating conditions	4
2	Absolute maximum ratings	4
3	Thermal characteristics	5
4	Electrical characteristics	6
4.1	DC characteristics	6
4.2	Characteristic DC diagrams	7
4.3	AC characteristics	9
4.3.1	AC characteristics in test fixture	9
4.3.2	Typical AC characteristic curves	19
5	Package information TSLP-7-1	23
	Revision history	25
	Disclaimer	26

Operating conditions

1 Operating conditions

Table 2 Operation conditions at $T_A = 25\text{ °C}$

Parameter	Symbol	Values			Unit	Note or test condition
		Min.	Typ.	Max.		
Supply voltage	V_{CC}	1.8	3	4	V	–
Control voltage in on-mode	$V_{Ctrl-on}$	1.2	–	V_{CC}		
Control voltage in off-mode	$V_{Ctrl-off}$	-0.3		0.3		

2 Absolute maximum ratings

Table 3 Absolute maximum ratings at $T_A = 25\text{ °C}$ (unless otherwise specified)

Parameter	Symbol	Values		Unit	Note or test condition
		Min.	Max.		
Supply voltage	V_{CC}	–	4	V	$T_A = 25\text{ °C}$
			3.5		
Supply current	I_{CC}		25	mA	–
DC current at RF_{in}	I_B		2		
Control voltage	V_{Ctrl}		4	V	
Total power dissipation ¹⁾	P_{tot}		100	mW	$T_S \leq 112\text{ °C}$
Junction temperature	T_J		150	°C	–
Storage temperature	T_{Stg}	-55			

Attention: Stresses above the max. values listed here may cause permanent damage to the device. Exposure to absolute maximum rating conditions for extended periods may affect device reliability. Exceeding only one of these values may cause irreversible damage to the integrated circuit.

¹ T_S is the soldering point temperature. T_S is measured on the emitter lead at the soldering point of the PCB.

Thermal characteristics

3 Thermal characteristics

Table 4 Thermal resistance

Parameter	Symbol	Values			Unit	Note or test condition
		Min.	Typ.	Max.		
Junction - soldering point	R_{thJS}	-	375	-	K/W	-

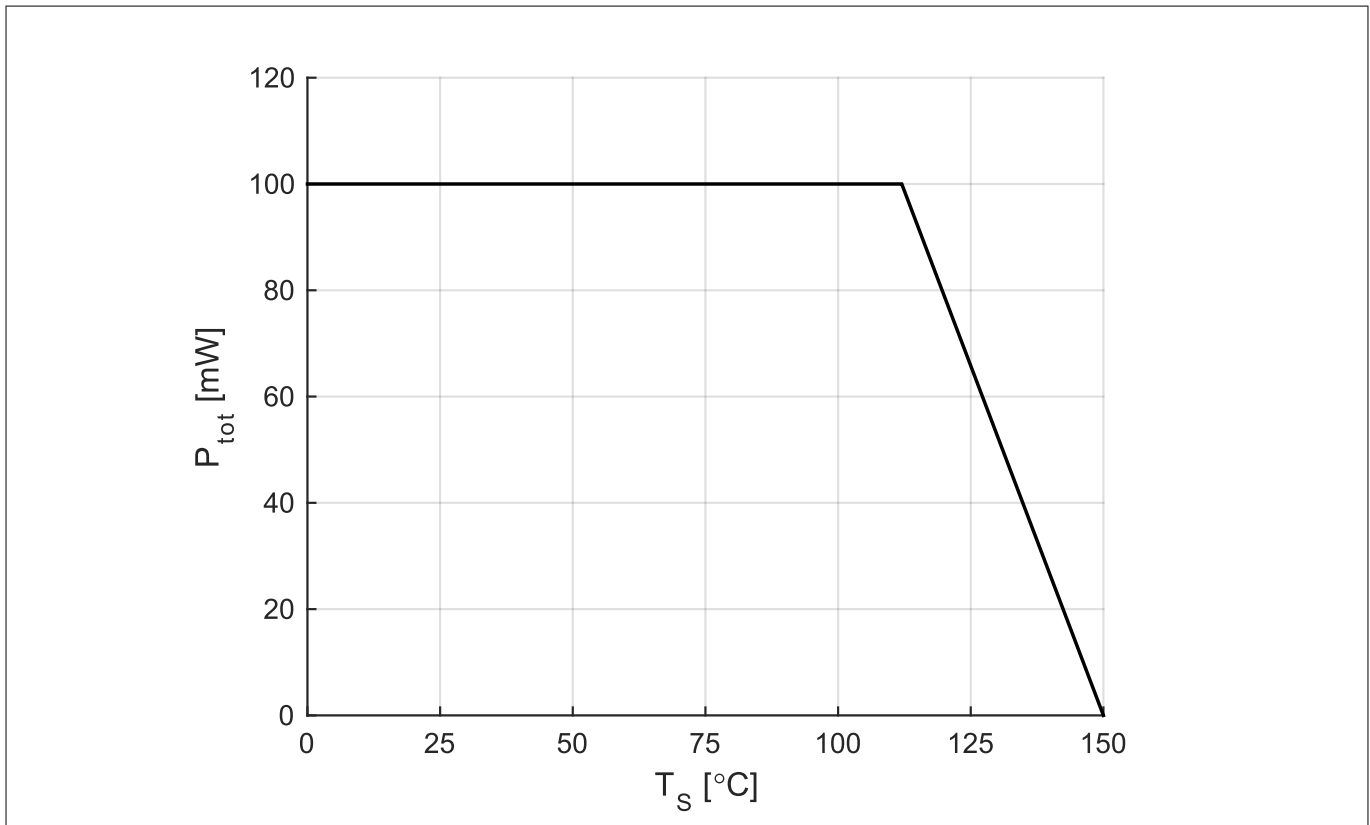

Figure 2 Total power dissipation $P_{tot} = f(T_S)$

 Electrical characteristics

4 Electrical characteristics

4.1 DC characteristics

 Table 5 DC characteristics at $V_{CC} = 3\text{ V}$, $T_A = 25\text{ °C}$

Parameter	Symbol	Values			Unit	Note or test condition
		Min.	Typ.	Max.		
Supply current in on-mode	I_{CC-on}	1.6	2.1	2.6	mA	$V_{Ctrl} = 3\text{ V}$ $R_{ext} = \text{open}$ $R_{ext} = 12\text{ k}\Omega$ $R_{ext} = 4.7\text{ k}\Omega$ $R_{ext} = 2.4\text{ k}\Omega$ $R_{ext} = 1\text{ k}\Omega$
		–	3	–		
		–	4.2	–		
		–	6	–		
		–	10	–		
Supply current in off-mode	I_{CC-off}	–	–	6	μA	$V_{Ctrl} = 0\text{ V}$
Control current in on-mode	$I_{Ctrl-on}$		14	20		$V_{Ctrl} = 3\text{ V}$
Control current in off-mode	$I_{Ctrl-off}$		–	0.1		$V_{Ctrl} = 0\text{ V}$

Electrical characteristics

4.2 Characteristic DC diagrams

The measurement setup is an application circuit according to [Figure 1](#) on page 2, using the integrated biasing. $T_A = 25\text{ }^\circ\text{C}$ (unless otherwise specified).

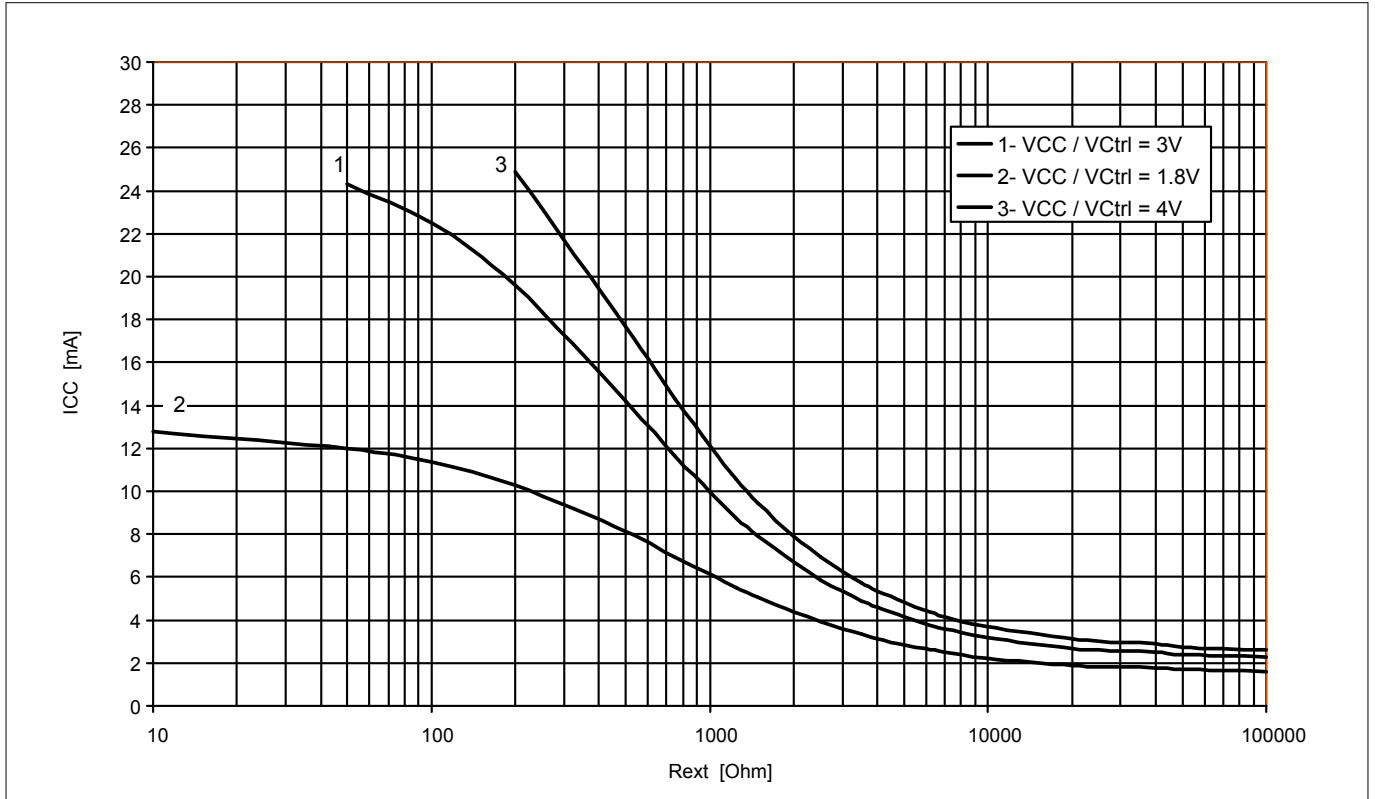

Figure 3 Supply current vs external resistance $I_{CC} = f(R_{ext}), V_{CC} / V_{ctrl} = \text{parameter}$

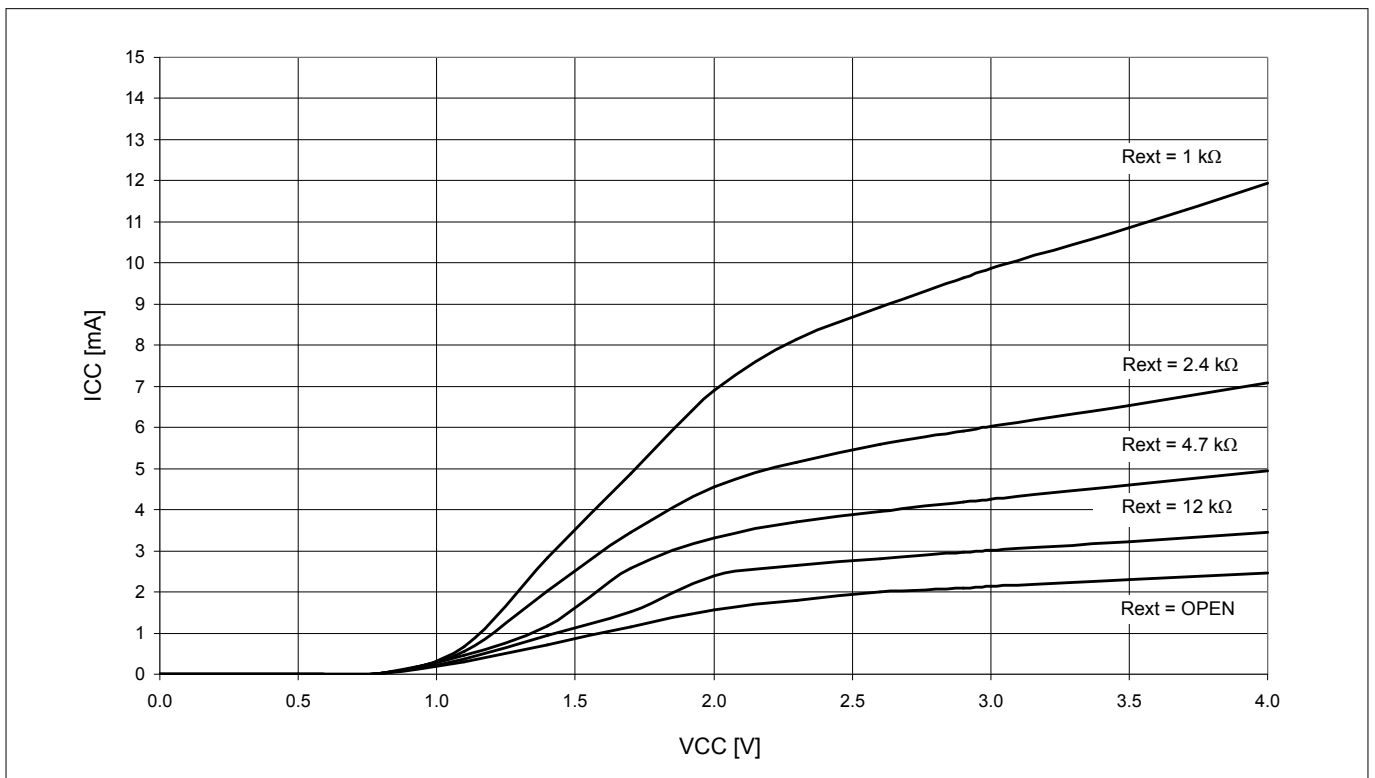

Figure 4 Supply current vs supply voltage $I_{CC} = f(V_{CC}), V_{ctrl} = 3V, R_{ext} = \text{parameter}$

Electrical characteristics

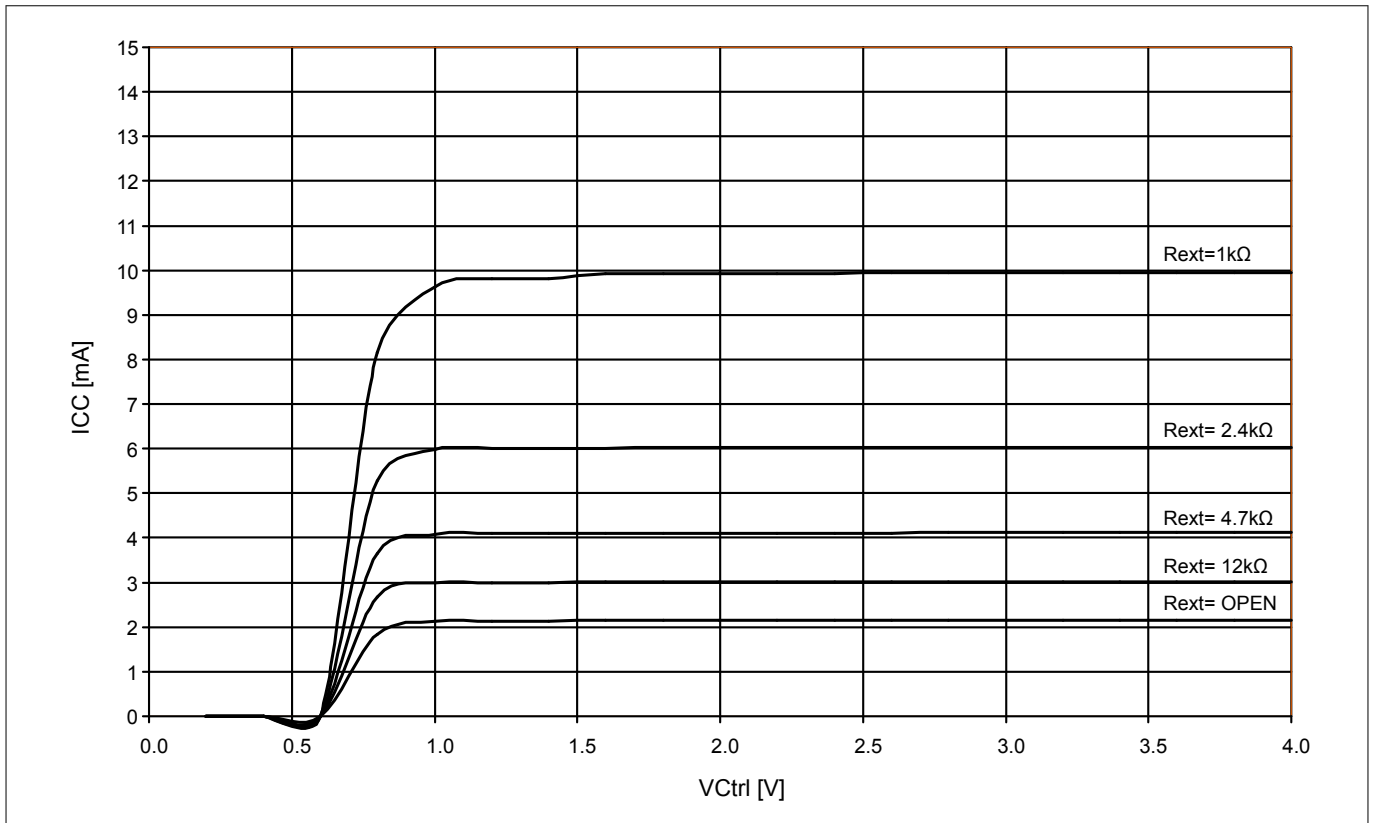

Figure 5 Supply current vs control voltage $I_{CC} = f(V_{Ctrl})$, $V_{CC} = 3 V$, $R_{ext} = \text{parameter}$

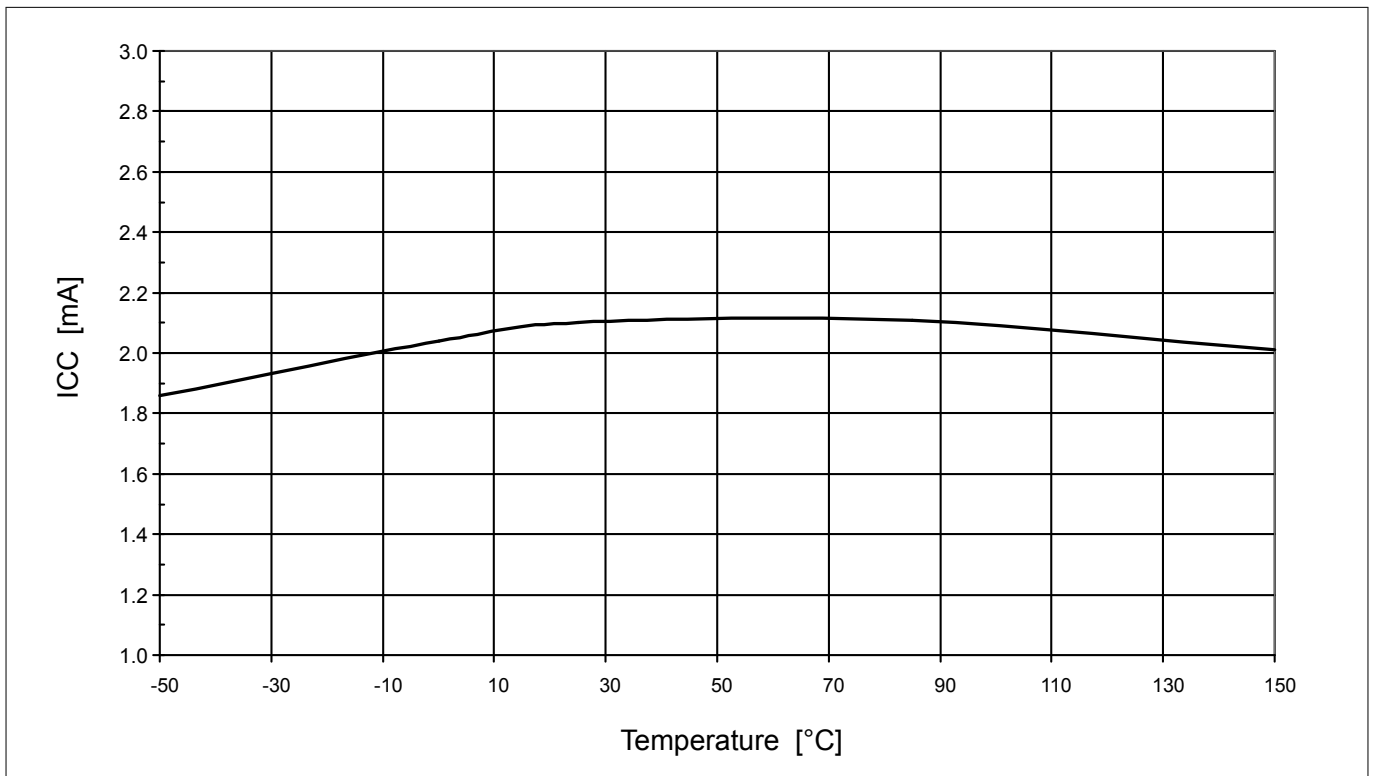

Figure 6 Supply current vs temperature $I_{CC} = f(T_A)$, $V_{Ctrl} = V_{CC} = 3 V$, $R_{ext} = \text{open}$

Electrical characteristics

4.3 AC characteristics

AC characteristics are described for higher frequencies in a 50 Ω environment.

4.3.1 AC characteristics in test fixture

Measurement setup is a test fixture with Bias-T's in a 50 Ω system according to [Figure 7](#), for frequencies f from 150 MHz to 10 GHz at $V_C = 3\text{ V}$, $T_A = 25\text{ °C}$. The collector current I_C is controlled by the external base voltage V_B . Which is not dependent of the biasing reference voltage V_{Bias} . The bias voltage V_C at the output RF_{out} allows direct measurement of the amplifier performance, as a function of bias conditions without passive components.

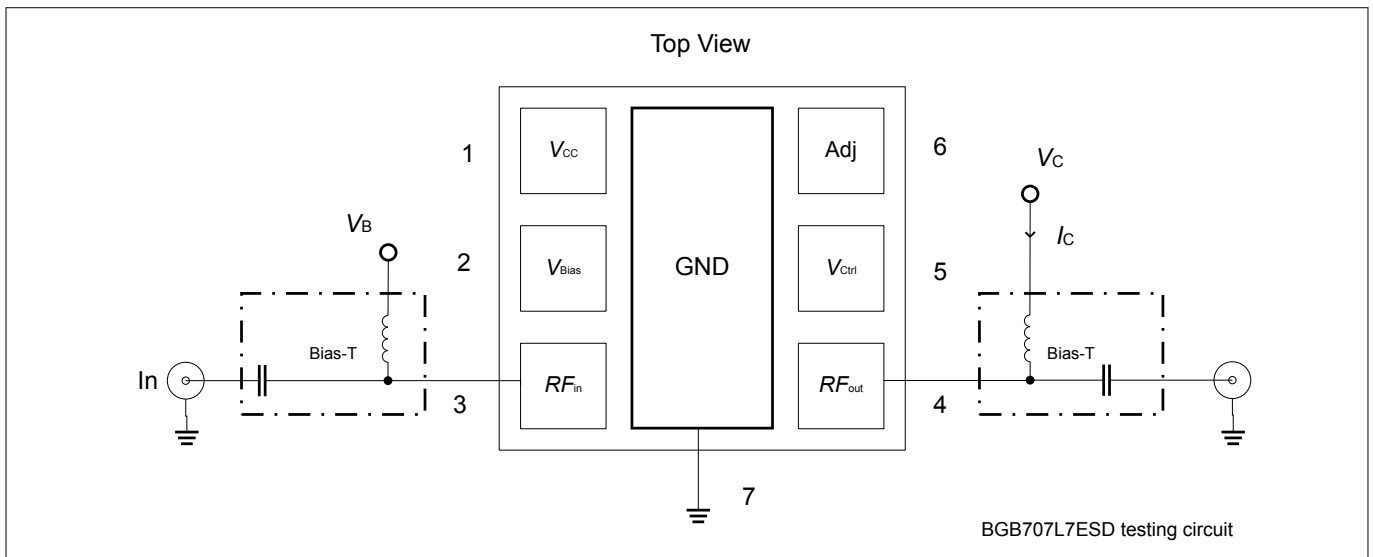

Figure 7 Testing circuit for frequencies f from 150 MHz to 10 GHz

Electrical characteristics

Table 6 AC characteristics, $V_C = 3\text{ V}$, $f = 150\text{ MHz}$

Parameter	Symbol	Values			Unit	Note or test conditions	
		Min.	Typ.	Max.			
Minimum noise figure	NF_{\min}	–	0.4 0.4 0.5 0.55	–	dB	$I_C = 2.1\text{ mA}$ $I_C = 3\text{ mA}$ $I_C = 6\text{ mA}$ $I_C = 10\text{ mA}$	
Transducer gain	$ S_{21} ^2$		17 19 24 27			$I_C = 2.1\text{ mA}$ $I_C = 3\text{ mA}$ $I_C = 6\text{ mA}$ $I_C = 10\text{ mA}$	
Maximum power gain	G_{ms}		31.5 33 35 37			$I_C = 2.1\text{ mA}$ $I_C = 3\text{ mA}$ $I_C = 6\text{ mA}$ $I_C = 10\text{ mA}$	
Output 1 dB gain compression point ¹⁾	$OP_{1\text{dB}}$		3.5 4 4.5 3			dBm	$I_{Cq} = 2.1\text{ mA}$, $I_{C\text{comp}} = 11\text{ mA}$ ²⁾ $I_{Cq} = 3\text{ mA}$, $I_{C\text{comp}} = 11\text{ mA}$ $I_{Cq} = 6\text{ mA}$, $I_{C\text{comp}} = 11\text{ mA}$ $I_{Cq} = 10\text{ mA}$, $I_{C\text{comp}} = 11\text{ mA}$
Output 3 rd order intercept point	OIP_3		2 6 14.5 19.5				$I_C = 2.1\text{ mA}$ $I_C = 3\text{ mA}$ $I_C = 6\text{ mA}$ $I_C = 10\text{ mA}$

¹ $OP_{1\text{dB}}$ is the output compression point achieved in a 50 Ω application circuit according to **Figure 1** using the integrated biasing.

² I_{Cq} is the quiescent current at small input power levels. I_{Cq} increases up to $I_{C\text{comp}}$ as RF input power approaches $IP_{1\text{dB}}$, cf. **Figure 14**.

Electrical characteristics

Table 7 AC characteristics, $V_C = 3\text{ V}$, $f = 450\text{ MHz}$

Parameter	Symbol	Values			Unit	Note or test conditions	
		Min.	Typ.	Max.			
Minimum noise figure	NF_{\min}	–	0.45 0.45 0.5 0.6	–	dB	$I_C = 2.1\text{ mA}$ $I_C = 3\text{ mA}$ $I_C = 6\text{ mA}$ $I_C = 10\text{ mA}$	
Transducer gain	$ S_{21} ^2$		17 19 24 27			$I_C = 2.1\text{ mA}$ $I_C = 3\text{ mA}$ $I_C = 6\text{ mA}$ $I_C = 10\text{ mA}$	
Maximum power gain	G_{ms}		27 28 30.5 32			$I_C = 2.1\text{ mA}$ $I_C = 3\text{ mA}$ $I_C = 6\text{ mA}$ $I_C = 10\text{ mA}$	
Output 1 dB gain compression point ¹⁾	$OP_{1\text{dB}}$		11.5 12 11.5 9.5			dBm	$I_{Cq} = 2.1\text{ mA}$, $I_{C\text{comp}} = 11\text{ mA}$ ²⁾ $I_{Cq} = 3\text{ mA}$, $I_{C\text{comp}} = 14\text{ mA}$ $I_{Cq} = 6\text{ mA}$, $I_{C\text{comp}} = 16\text{ mA}$ $I_{Cq} = 10\text{ mA}$, $I_{C\text{comp}} = 15\text{ mA}$
Output 3 rd order intercept point	OIP_3		2 5.5 14 19.5				$I_C = 2.1\text{ mA}$ $I_C = 3\text{ mA}$ $I_C = 6\text{ mA}$ $I_C = 10\text{ mA}$

¹ $OP_{1\text{dB}}$ is the output compression point achieved in a $50\ \Omega$ application circuit according to [Figure 1](#) using the integrated biasing.

² I_{Cq} is the quiescent current at small input power levels. I_{Cq} increases up to $I_{C\text{comp}}$ as RF input power approaches $IP_{1\text{dB}}$, cf. [Figure 14](#).

Electrical characteristics

Table 8 AC characteristics, $V_C = 3\text{ V}$, $f = 900\text{ MHz}$

Parameter	Symbol	Values			Unit	Note or test conditions	
		Min.	Typ.	Max.			
Minimum noise figure	NF_{\min}	–	0.55 0.55 0.6 0.7	–	dB	$I_C = 2.1\text{ mA}$ $I_C = 3\text{ mA}$ $I_C = 6\text{ mA}$ $I_C = 10\text{ mA}$	
Transducer gain	$ S_{21} ^2$		17 19 23.5 26			$I_C = 2.1\text{ mA}$ $I_C = 3\text{ mA}$ $I_C = 6\text{ mA}$ $I_C = 10\text{ mA}$	
Maximum power gain	G_{ms}		24 25 27.5 29			$I_C = 2.1\text{ mA}$ $I_C = 3\text{ mA}$ $I_C = 6\text{ mA}$ $I_C = 10\text{ mA}$	
Output 1 dB gain compression point ¹⁾	$OP_{1\text{dB}}$		11 11 10 8.5			dBm	$I_{Cq} = 2.1\text{ mA}$, $I_{C\text{comp}} = 13\text{ mA}$ ²⁾ $I_{Cq} = 3\text{ mA}$, $I_{C\text{comp}} = 15\text{ mA}$ $I_{Cq} = 6\text{ mA}$, $I_{C\text{comp}} = 14\text{ mA}$ $I_{Cq} = 10\text{ mA}$, $I_{C\text{comp}} = 14\text{ mA}$
Output 3 rd order intercept point	OIP_3		3.5 8 17 19.5				$I_C = 2.1\text{ mA}$ $I_C = 3\text{ mA}$ $I_C = 6\text{ mA}$ $I_C = 10\text{ mA}$

¹ $OP_{1\text{dB}}$ is the output compression point achieved in a $50\ \Omega$ application circuit according to [Figure 1](#) using the integrated biasing.

² I_{Cq} is the quiescent current at small input power levels. I_{Cq} increases up to $I_{C\text{comp}}$ as RF input power approaches $IP_{1\text{dB}}$, cf. [Figure 14](#).

Electrical characteristics

Table 9 AC characteristics, $V_C = 3\text{ V}$, $f = 1.5\text{ GHz}$

Parameter	Symbol	Values			Unit	Note or test conditions	
		Min.	Typ.	Max.			
Minimum noise figure	NF_{\min}	–	0.6 0.6 0.6 0.7	–	dB	$I_C = 2.1\text{ mA}$ $I_C = 3\text{ mA}$ $I_C = 6\text{ mA}$ $I_C = 10\text{ mA}$	
Transducer gain	$ S_{21} ^2$		16 18.5 22.5 24.5			$I_C = 2.1\text{ mA}$ $I_C = 3\text{ mA}$ $I_C = 6\text{ mA}$ $I_C = 10\text{ mA}$	
Maximum power gain	G_{ms}		21.5 23 25.5 27			$I_C = 2.1\text{ mA}$ $I_C = 3\text{ mA}$ $I_C = 6\text{ mA}$ $I_C = 10\text{ mA}$	
Output 1 dB gain compression point ¹⁾	$OP_{1\text{dB}}$		10.5 10 9 8			dBm	$I_{Cq} = 2.1\text{ mA}$, $I_{C\text{comp}} = 14\text{ mA}$ ²⁾ $I_{Cq} = 3\text{ mA}$, $I_{C\text{comp}} = 16\text{ mA}$ $I_{Cq} = 6\text{ mA}$, $I_{C\text{comp}} = 15\text{ mA}$ $I_{Cq} = 10\text{ mA}$, $I_{C\text{comp}} = 15\text{ mA}$
Output 3 rd order intercept point	OIP_3		3.5 8 17 19.5				$I_C = 2.1\text{ mA}$ $I_C = 3\text{ mA}$ $I_C = 6\text{ mA}$ $I_C = 10\text{ mA}$

¹ $OP_{1\text{dB}}$ is the output compression point achieved in a $50\ \Omega$ application circuit according to [Figure 1](#) using the integrated biasing.

² I_{Cq} is the quiescent current at small input power levels. I_{Cq} increases up to $I_{C\text{comp}}$ as RF input power approaches $IP_{1\text{dB}}$, cf. [Figure 14](#).

Electrical characteristics

Table 10 AC characteristics, $V_C = 3\text{ V}$, $f = 1.9\text{ GHz}$

Parameter	Symbol	Values			Unit	Note or test conditions	
		Min.	Typ.	Max.			
Minimum noise figure	NF_{\min}	–	0.6 0.6 0.6 0.7	–	dB	$I_C = 2.1\text{ mA}$ $I_C = 3\text{ mA}$ $I_C = 6\text{ mA}$ $I_C = 10\text{ mA}$	
Transducer gain	$ S_{21} ^2$		16 18 21.5 23			$I_C = 2.1\text{ mA}$ $I_C = 3\text{ mA}$ $I_C = 6\text{ mA}$ $I_C = 10\text{ mA}$	
Maximum power gain	G_{ms}		21 22 24 26			$I_C = 2.1\text{ mA}$ $I_C = 3\text{ mA}$ $I_C = 6\text{ mA}$ $I_C = 10\text{ mA}$	
Output 1 dB gain compression point ¹⁾	$OP_{1\text{dB}}$		10 10 8.5 8			dBm	$I_{Cq} = 2.1\text{ mA}$, $I_{C\text{comp}} = 15\text{ mA}$ ²⁾ $I_{Cq} = 3\text{ mA}$, $I_{C\text{comp}} = 16\text{ mA}$ $I_{Cq} = 6\text{ mA}$, $I_{C\text{comp}} = 14\text{ mA}$ $I_{Cq} = 10\text{ mA}$, $I_{C\text{comp}} = 14\text{ mA}$
Output 3 rd order intercept point	OIP_3		3.5 7.5 17 19.5				$I_C = 2.1\text{ mA}$ $I_C = 3\text{ mA}$ $I_C = 6\text{ mA}$ $I_C = 10\text{ mA}$

¹ $OP_{1\text{dB}}$ is the output compression point achieved in a $50\ \Omega$ application circuit according to [Figure 1](#) using the integrated biasing.

² I_{Cq} is the quiescent current at small input power levels. I_{Cq} increases up to $I_{C\text{comp}}$ as RF input power approaches $IP_{1\text{dB}}$, cf. [Figure 14](#).

Electrical characteristics

Table 11 AC characteristics, $V_C = 3\text{ V}$, $f = 2.4\text{ GHz}$

Parameter	Symbol	Values			Unit	Note or test conditions	
		Min.	Typ.	Max.			
Minimum noise figure	NF_{\min}	–	0.65 0.6 0.6 0.7	–	dB	$I_C = 2.1\text{ mA}$ $I_C = 3\text{ mA}$ $I_C = 6\text{ mA}$ $I_C = 10\text{ mA}$	
Transducer gain	$ S_{21} ^2$		15.5 17 20 21.5			$I_C = 2.1\text{ mA}$ $I_C = 3\text{ mA}$ $I_C = 6\text{ mA}$ $I_C = 10\text{ mA}$	
Maximum power gain	G_{ms}		20 21 23 25			$I_C = 2.1\text{ mA}$ $I_C = 3\text{ mA}$ $I_C = 6\text{ mA}$ $I_C = 10\text{ mA}$	
Output 1 dB gain compression point ¹⁾	$OP_{1\text{dB}}$		10 10 9 8			dBm	$I_{Cq} = 2.1\text{ mA}$, $I_{C\text{comp}} = 15\text{ mA}$ ²⁾ $I_{Cq} = 3\text{ mA}$, $I_{C\text{comp}} = 16\text{ mA}$ $I_{Cq} = 6\text{ mA}$, $I_{C\text{comp}} = 14\text{ mA}$ $I_{Cq} = 10\text{ mA}$, $I_{C\text{comp}} = 14\text{ mA}$
Output 3 rd order intercept point	OIP_3		4.5 9 17.5 19.5				$I_C = 2.1\text{ mA}$ $I_C = 3\text{ mA}$ $I_C = 6\text{ mA}$ $I_C = 10\text{ mA}$

¹ $OP_{1\text{dB}}$ is the output compression point achieved in a $50\ \Omega$ application circuit according to [Figure 1](#) using the integrated biasing.

² I_{Cq} is the quiescent current at small input power levels. I_{Cq} increases up to $I_{C\text{comp}}$ as RF input power approaches $IP_{1\text{dB}}$, cf. [Figure 14](#).

Electrical characteristics

Table 12 AC characteristics, $V_C = 3\text{ V}$, $f = 3.5\text{ GHz}$

Parameter	Symbol	Values			Unit	Note or test conditions
		Min.	Typ.	Max.		
Minimum noise figure	NF_{\min}	–	0.8 0.75 0.7 0.75	–	dB	$I_C = 2.1\text{ mA}$ $I_C = 3\text{ mA}$ $I_C = 6\text{ mA}$ $I_C = 10\text{ mA}$
Transducer gain	$ S_{21} ^2$		13.5 15.5 18 19			$I_C = 2.1\text{ mA}$ $I_C = 3\text{ mA}$ $I_C = 6\text{ mA}$ $I_C = 10\text{ mA}$
Maximum power gain	G_{ms}		18.5 20 22 23.5			$I_C = 2.1\text{ mA}$ $I_C = 3\text{ mA}$ $I_C = 6\text{ mA}$ $I_C = 10\text{ mA}$
Output 1 dB gain compression point ¹⁾	$OP_{1\text{dB}}$		10 10 9 8			dBm
Output 3 rd order intercept point	OIP_3		5.5 12 17.5 19		$I_C = 2.1\text{ mA}$ $I_C = 3\text{ mA}$ $I_C = 6\text{ mA}$ $I_C = 10\text{ mA}$	

¹ $OP_{1\text{dB}}$ is the output compression point achieved in a $50\ \Omega$ application circuit according to [Figure 1](#) using the integrated biasing.

² I_{Cq} is the quiescent current at small input power levels. I_{Cq} increases up to $I_{C\text{comp}}$ as RF input power approaches $IP_{1\text{dB}}$, cf. [Figure 14](#).

Electrical characteristics

Table 13 AC characteristics, $V_C = 3\text{ V}$, $f = 5.5\text{ GHz}$

Parameter	Symbol	Values			Unit	Note or test conditions	
		Min.	Typ.	Max.			
Minimum noise figure	NF_{\min}	–	1.05 1 0.9 0.95	–	dB	$I_C = 2.1\text{ mA}$ $I_C = 3\text{ mA}$ $I_C = 6\text{ mA}$ $I_C = 10\text{ mA}$	
Transducer gain	$ S_{21} ^2$		11.5 13 15 15.5			$I_C = 2.1\text{ mA}$ $I_C = 3\text{ mA}$ $I_C = 6\text{ mA}$ $I_C = 10\text{ mA}$	
Maximum power gain	G_{ms}		17.5 18.5 20 19			$I_C = 2.1\text{ mA}$ $I_C = 3\text{ mA}$ $I_C = 6\text{ mA}$ $I_C = 10\text{ mA}$	
Output 1 dB gain compression point ¹⁾	$OP_{1\text{dB}}$		10.5 10 9 8			dBm	$I_{Cq} = 2.1\text{ mA}$, $I_{C\text{comp}} = 17\text{ mA}$ ²⁾ $I_{Cq} = 3\text{ mA}$, $I_{C\text{comp}} = 17\text{ mA}$ $I_{Cq} = 6\text{ mA}$, $I_{C\text{comp}} = 15\text{ mA}$ $I_{Cq} = 10\text{ mA}$, $I_{C\text{comp}} = 15\text{ mA}$
Output 3 rd order intercept point	OIP_3		6.5 12 22 21				$I_C = 2.1\text{ mA}$ $I_C = 3\text{ mA}$ $I_C = 6\text{ mA}$ $I_C = 10\text{ mA}$

¹ $OP_{1\text{dB}}$ is the output compression point achieved in a $50\ \Omega$ application circuit according to [Figure 1](#) using the integrated biasing.

² I_{Cq} is the quiescent current at small input power levels. I_{Cq} increases up to $I_{C\text{comp}}$ as RF input power approaches $IP_{1\text{dB}}$, cf. [Figure 14](#).

Electrical characteristics

Table 14 AC characteristics, $V_C = 3\text{ V}$, $f = 10\text{ GHz}$

Parameter	Symbol	Values			Unit	Note or test conditions
		Min.	Typ.	Max.		
Minimum noise figure	NF_{\min}	-	2	-	dB	$I_C = 2.1\text{ mA}$ $I_C = 3\text{ mA}$ $I_C = 6\text{ mA}$ $I_C = 10\text{ mA}$
			1.8			
			1.5			
			1.5			
Transducer gain	$ S_{21} ^2$		5.5			$I_C = 2.1\text{ mA}$ $I_C = 3\text{ mA}$ $I_C = 6\text{ mA}$ $I_C = 10\text{ mA}$
			7			
			9			
			10			
Maximum power gain	G_{ms}		14.5			$I_C = 2.1\text{ mA}$ $I_C = 3\text{ mA}$ $I_C = 6\text{ mA}$ $I_C = 10\text{ mA}$
			15			
			15.5			
			15.5			
Output 1 dB gain compression point ¹⁾	$OP_{1\text{dB}}$		6		dBm	$I_{Cq} = 2.1\text{ mA}$, $I_{C\text{comp}} = 16\text{ mA}$ ²⁾ $I_{Cq} = 3\text{ mA}$, $I_{C\text{comp}} = 16\text{ mA}$ $I_{Cq} = 6\text{ mA}$, $I_{C\text{comp}} = 15\text{ mA}$ $I_{Cq} = 10\text{ mA}$, $I_{C\text{comp}} = 15\text{ mA}$
			6			
			4			
			4			
Output 3 rd order intercept point	OIP_3		2.5			$I_C = 2.1\text{ mA}$ $I_C = 3\text{ mA}$ $I_C = 6\text{ mA}$ $I_C = 10\text{ mA}$
			7			
			19.5			
			18			

¹ $OP_{1\text{dB}}$ is the output compression point achieved in a 50 Ω application circuit according to **Figure 1** using the integrated biasing.

² I_{Cq} is the quiescent current at small input power levels. I_{Cq} increases up to $I_{C\text{comp}}$ as RF input power approaches $IP_{1\text{dB}}$, cf. **Figure 14**.

Electrical characteristics

4.3.2 Typical AC characteristic curves

Measurement setup is as described in *Figure 7* except for *Figure 14*, where the compression point is measured in a 50 Ω application circuit according to *Figure 1* using the integrated biasing at $V_C = 3\text{ V}$, $T_A = 25\text{ °C}$.

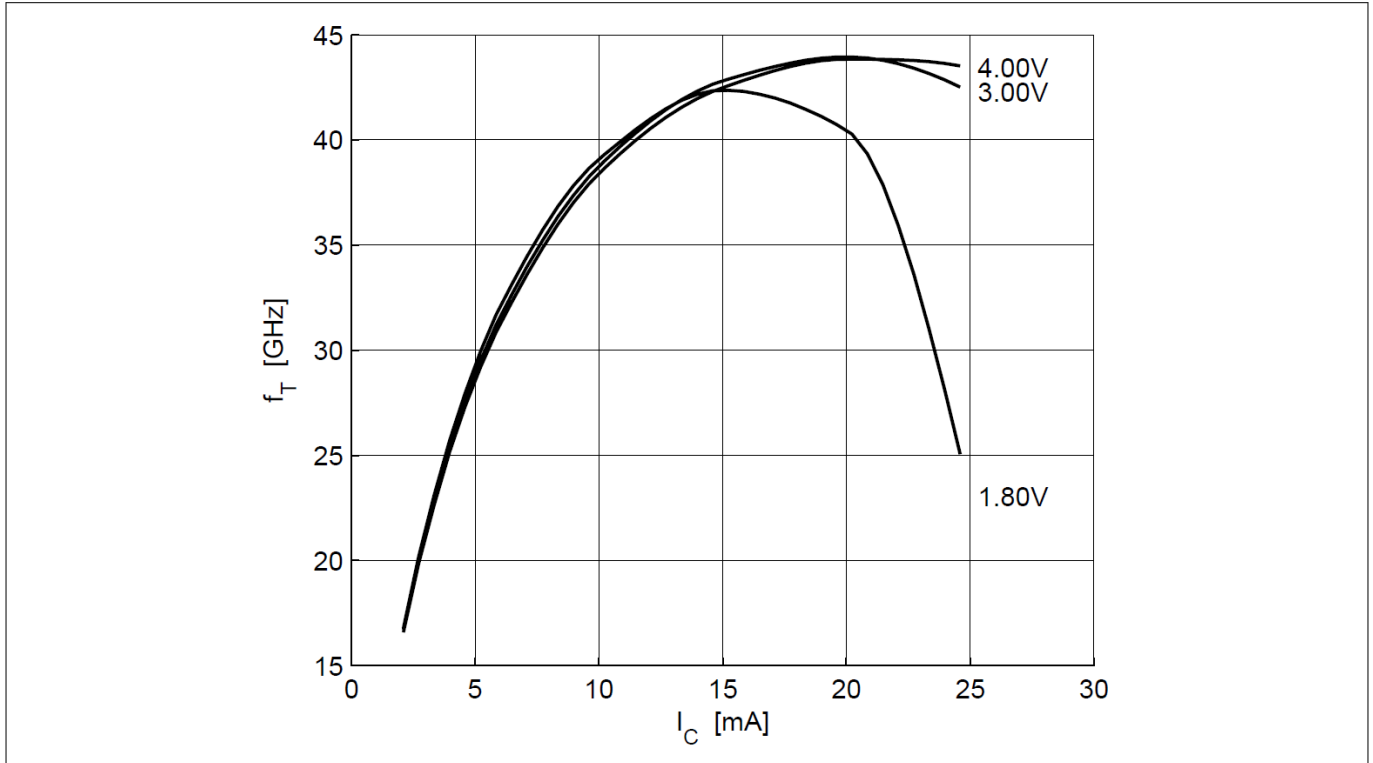

Figure 8 Transition frequency $f_T = f(I_C)$, $V_C = \text{parameter}$

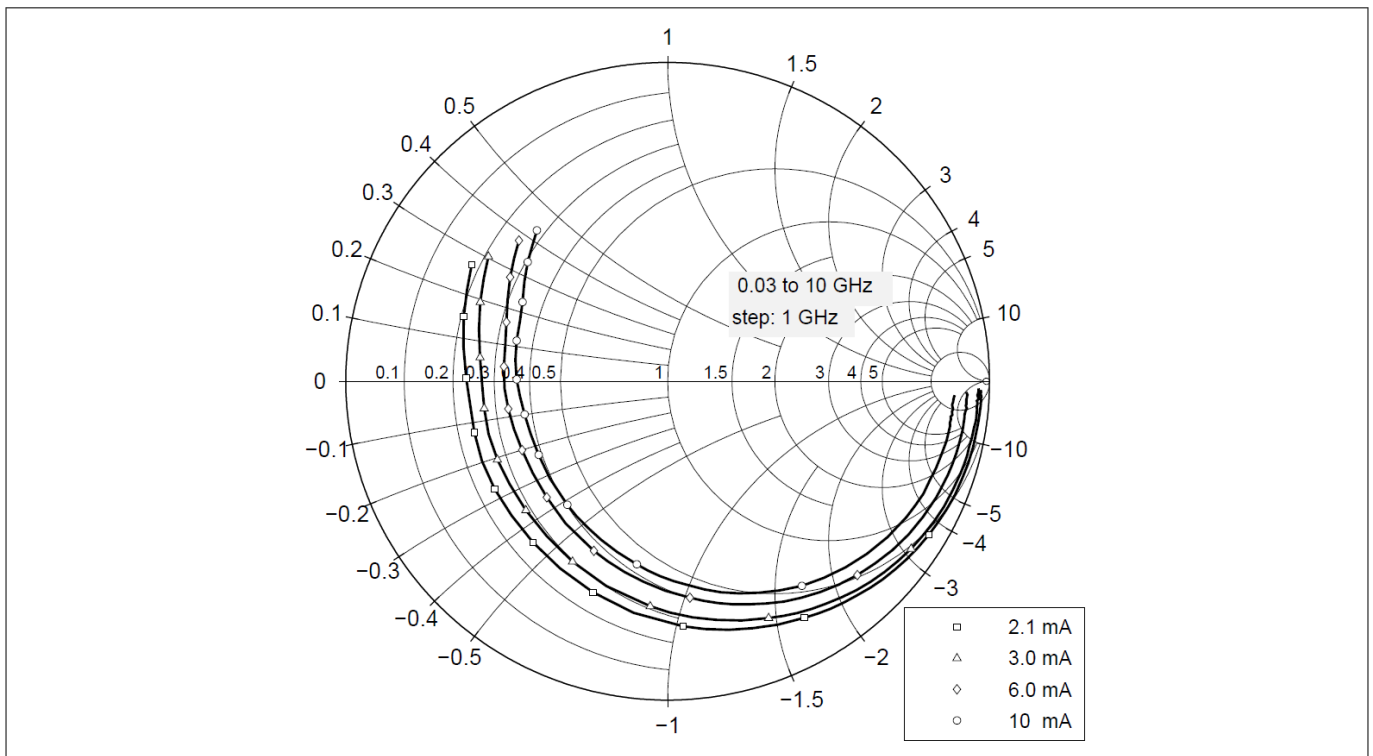

Figure 9 Input reflection coefficient $S_{11} = f(f)$, $I_C = \text{parameter}$

Electrical characteristics

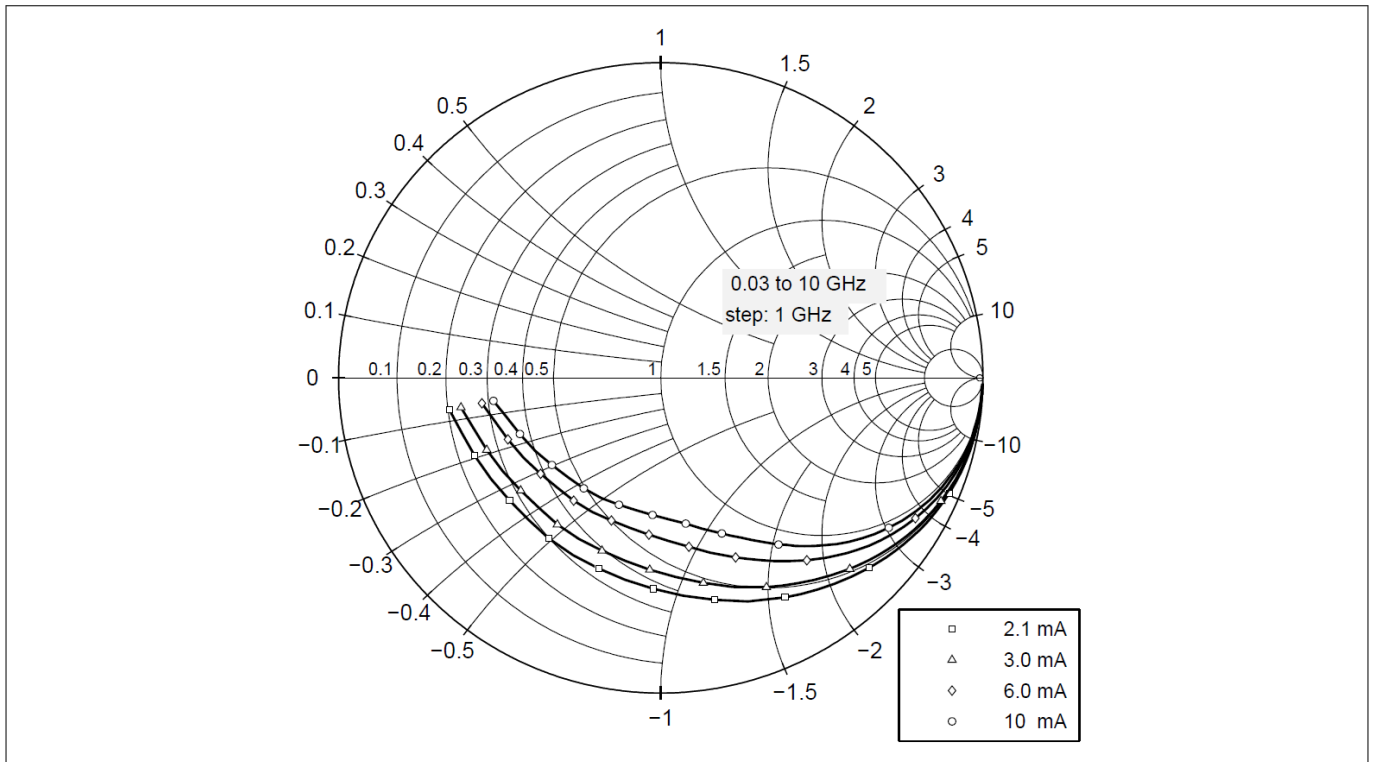

Figure 10 Output reflection coefficient $S_{22} = f(f)$, $I_c = \text{parameter}$

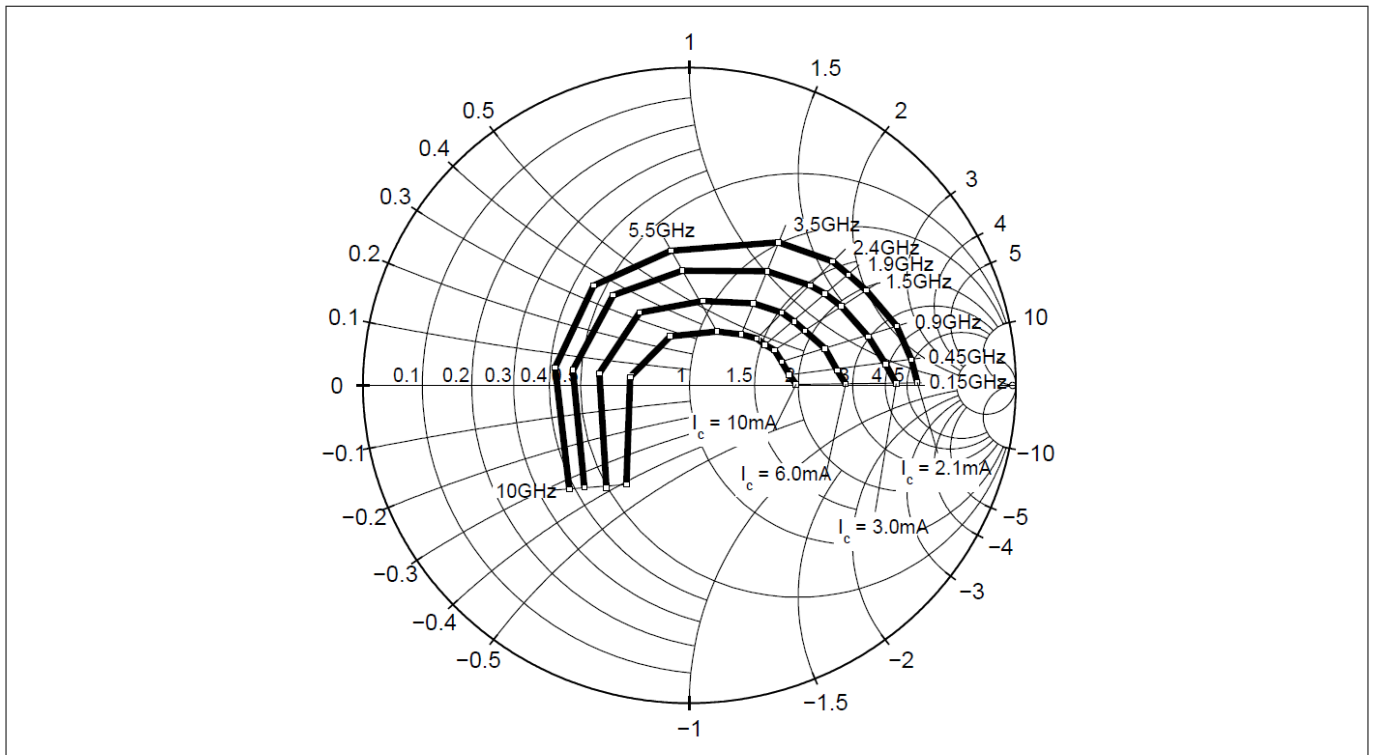

Figure 11 Source impedance for minimum noise figure $Z_{s,opt} = f(f)$, $I_c = \text{parameter}$

Electrical characteristics

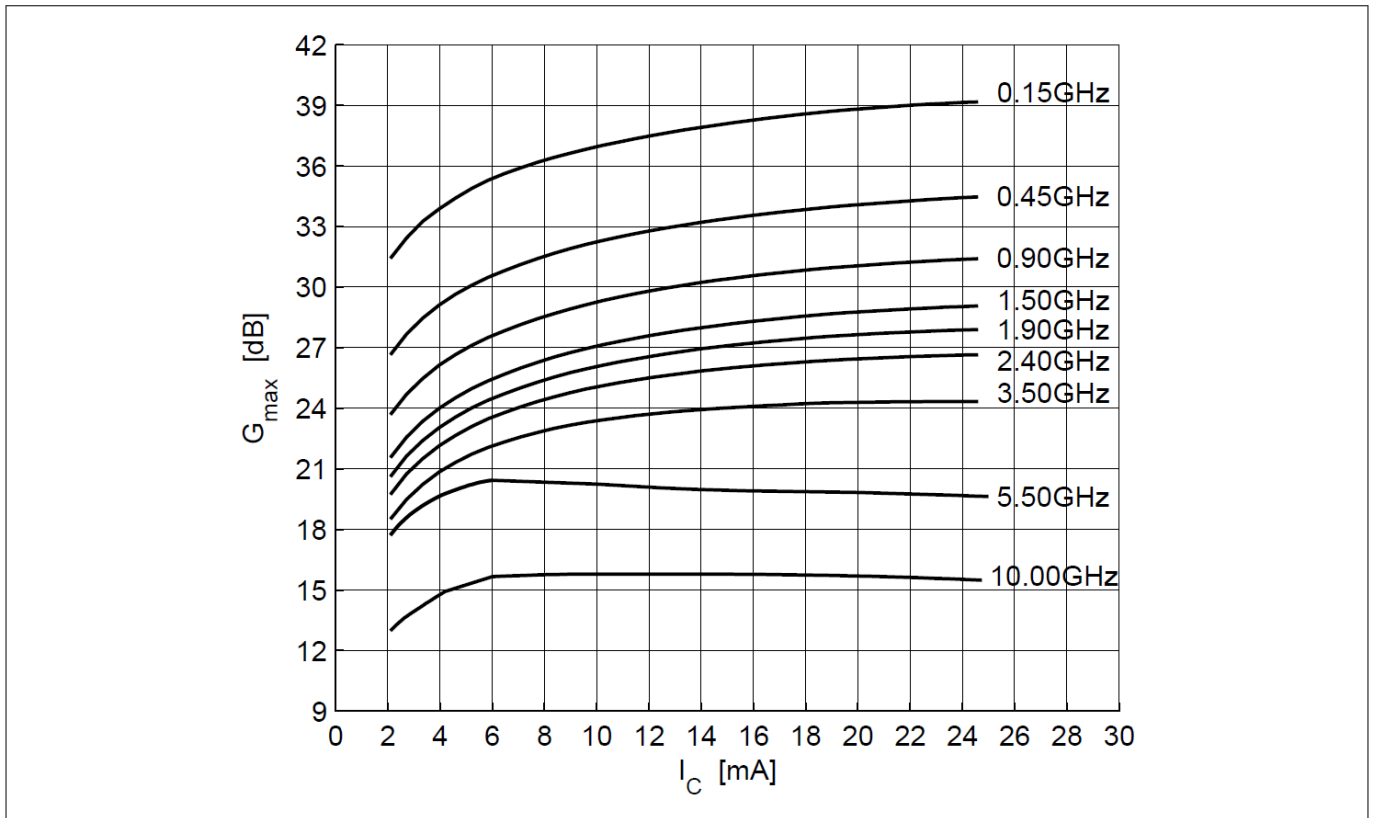

Figure 12 Maximum power gain $G_{max} = f(I_C)$, $f = \text{parameter}$

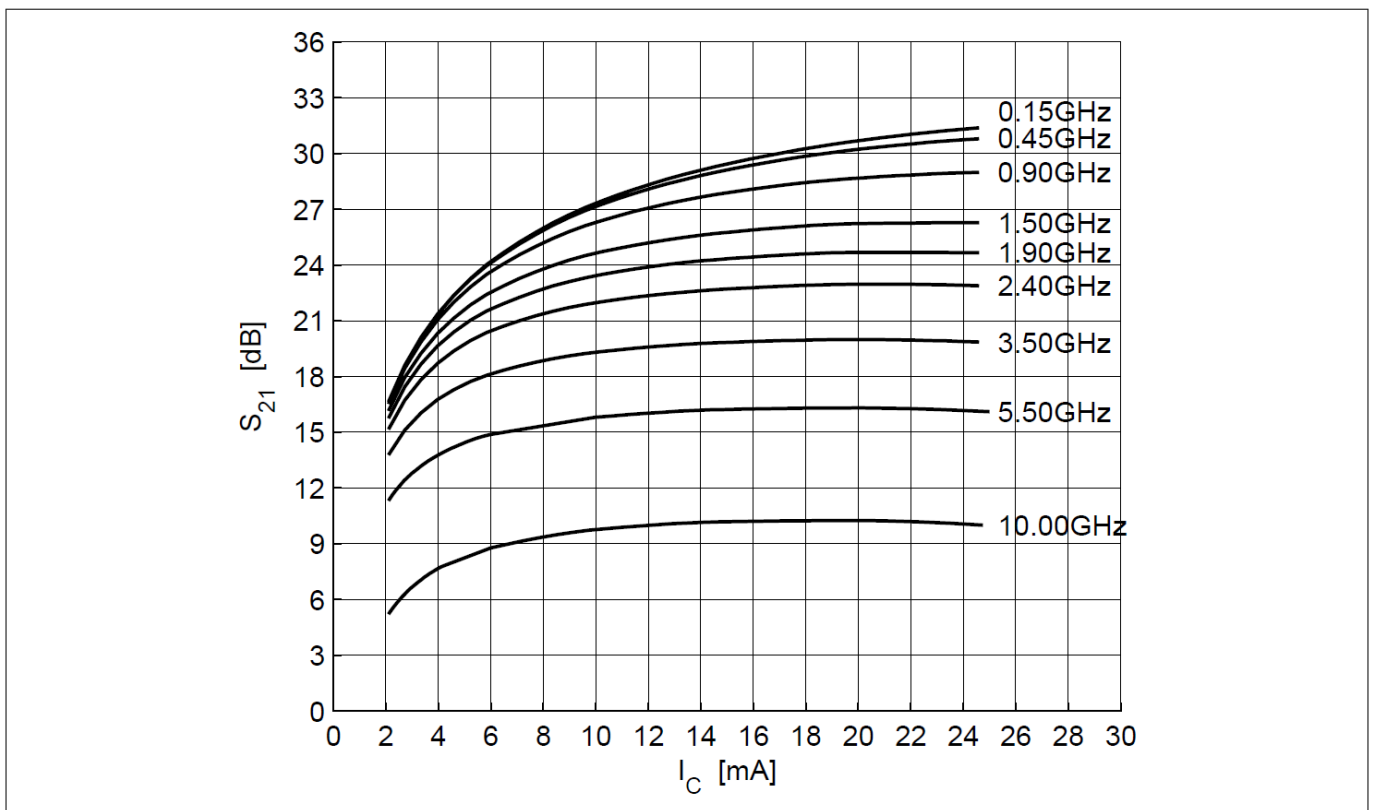

Figure 13 Transducer gain $|S_{21}|^2 = f(I_C)$, $f = \text{parameter}$

Electrical characteristics

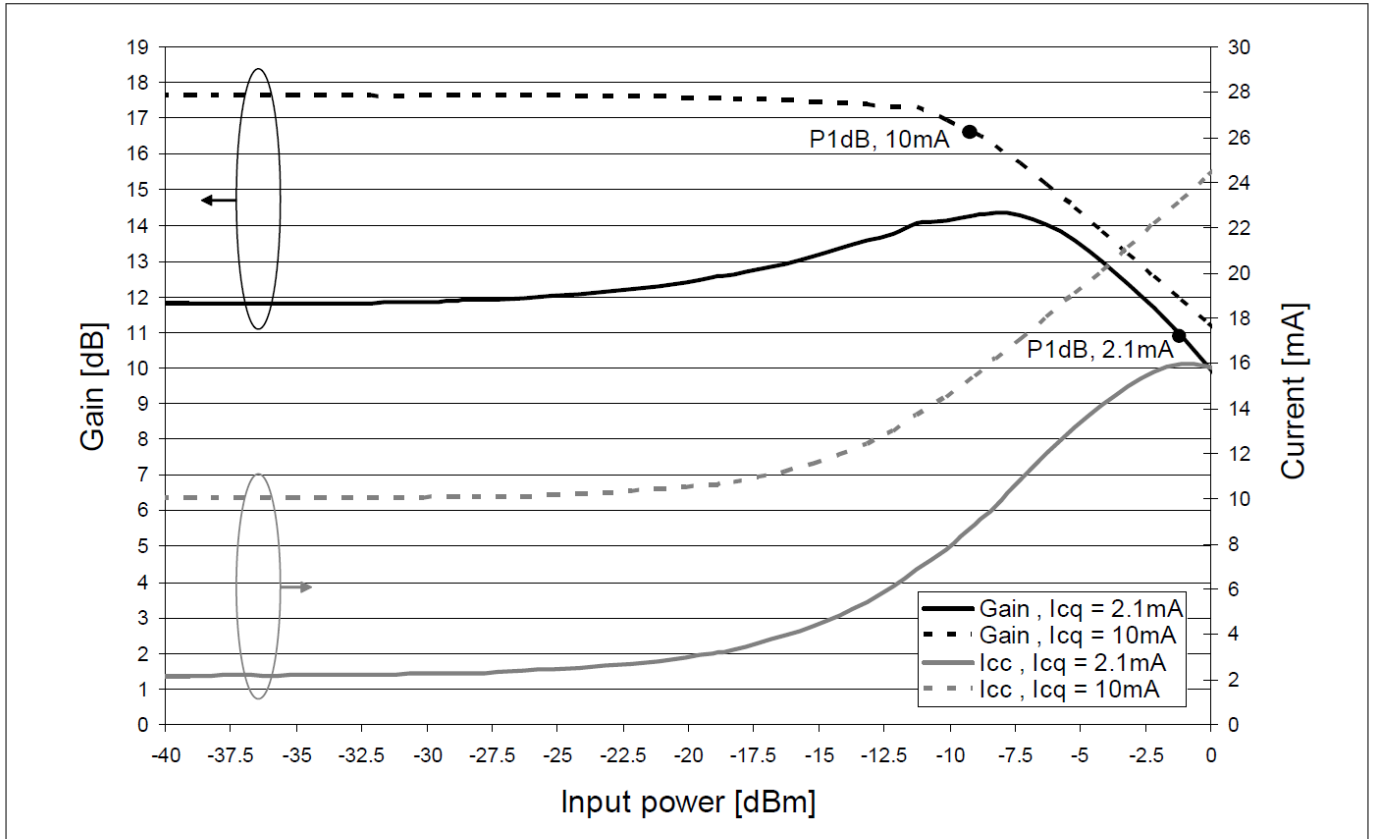

Figure 14 Power gain $G = f(P_{RFin})$ and supply current $I_{cc} = f(P_{RFin})$ at frequency $f = 3.5\text{ GHz}$, I_{cq} = parameter

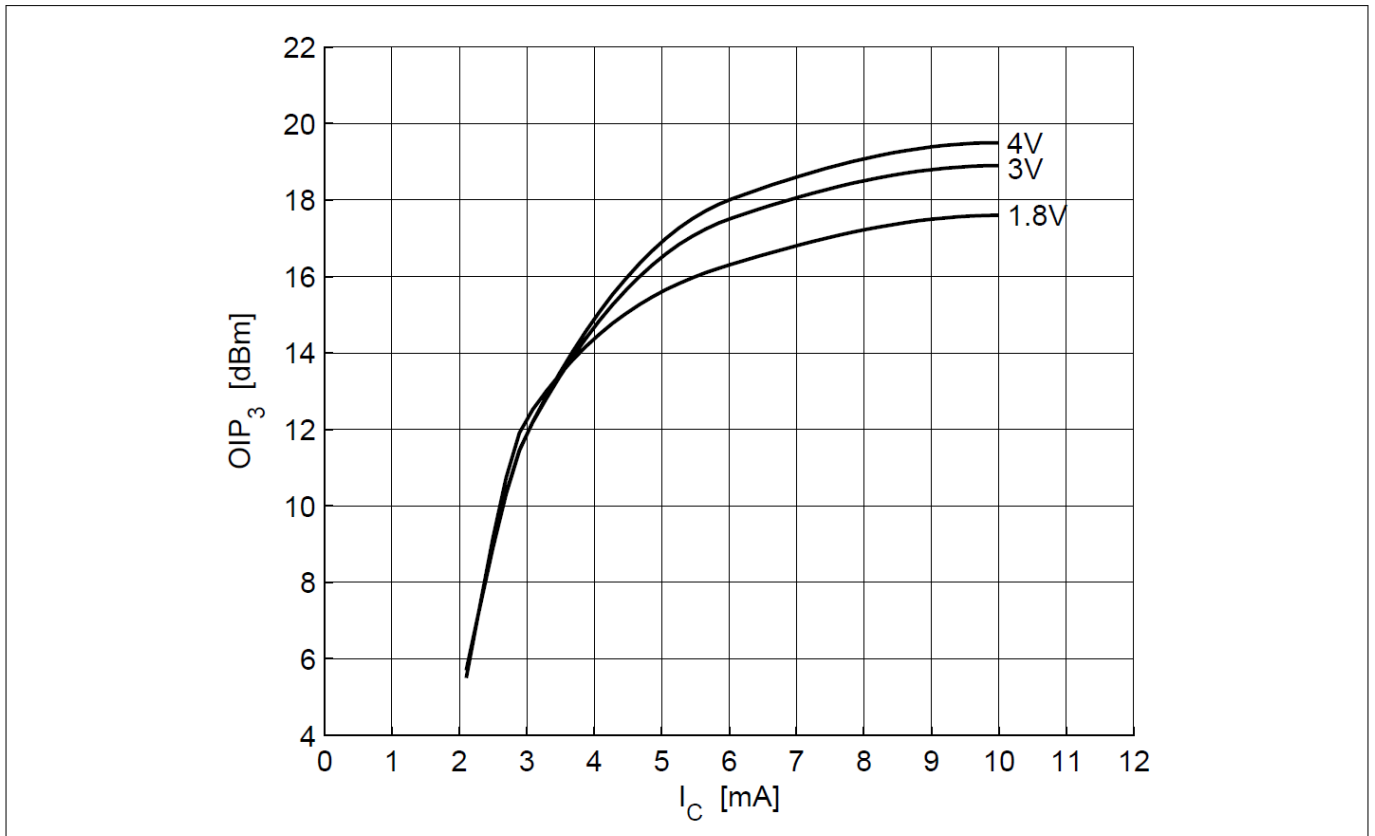

Figure 15 Output 3rd order intercept point $OIP_3 = f(I_C)$ at frequency $f = 3.5\text{ GHz}$, V_C = parameter

5 Package information TSLP-7-1

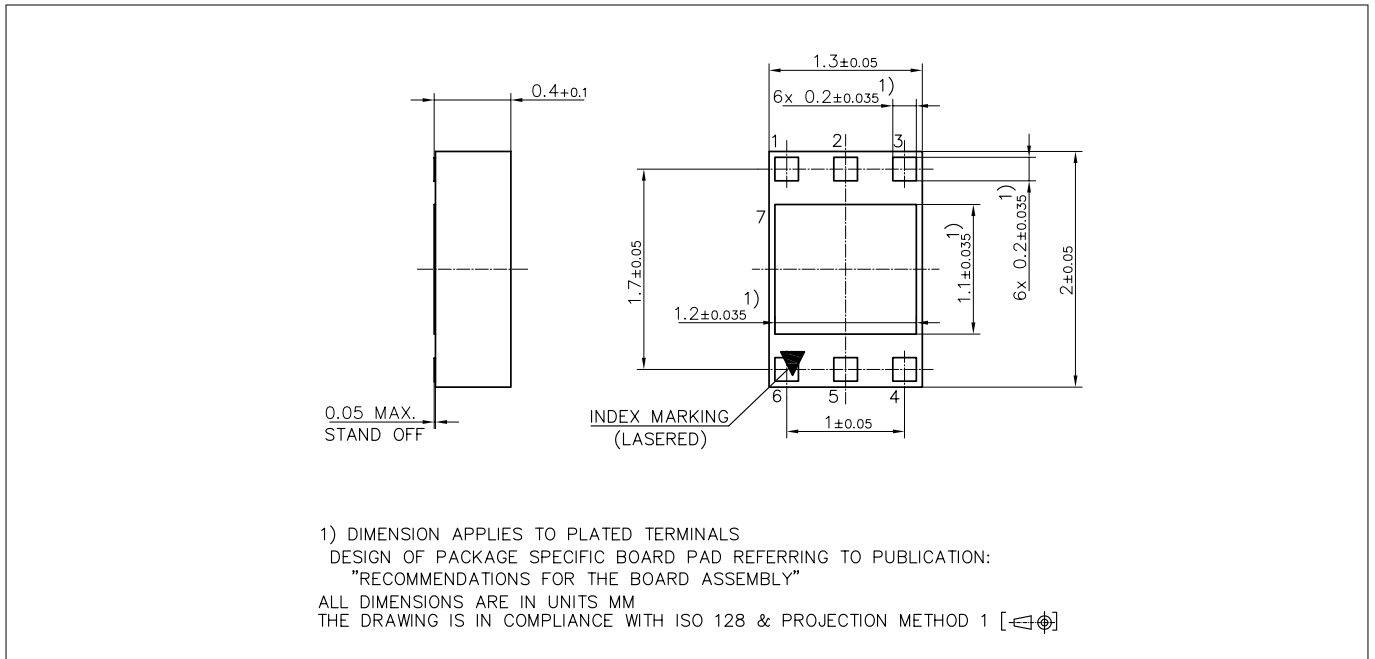

Figure 16 Package outline

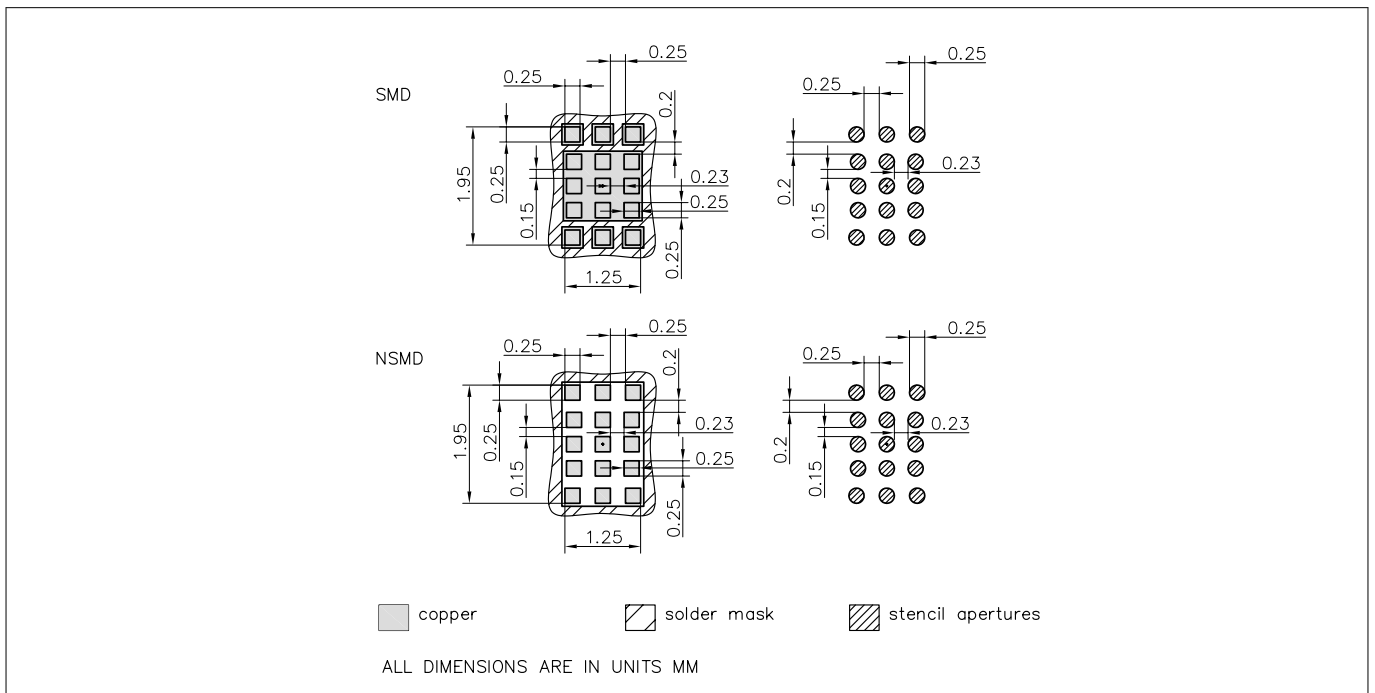

Figure 17 Foot print

Package information TSLP-7-1

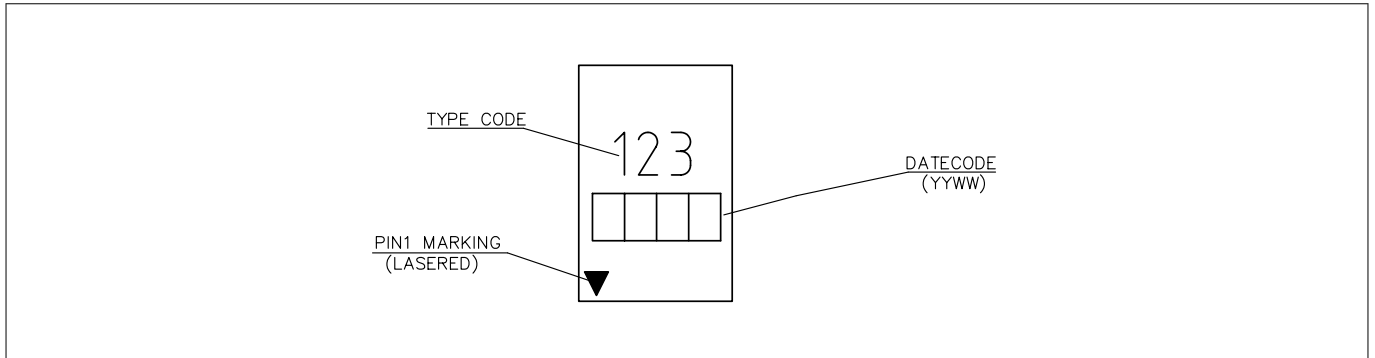

Figure 18 Marking layout example

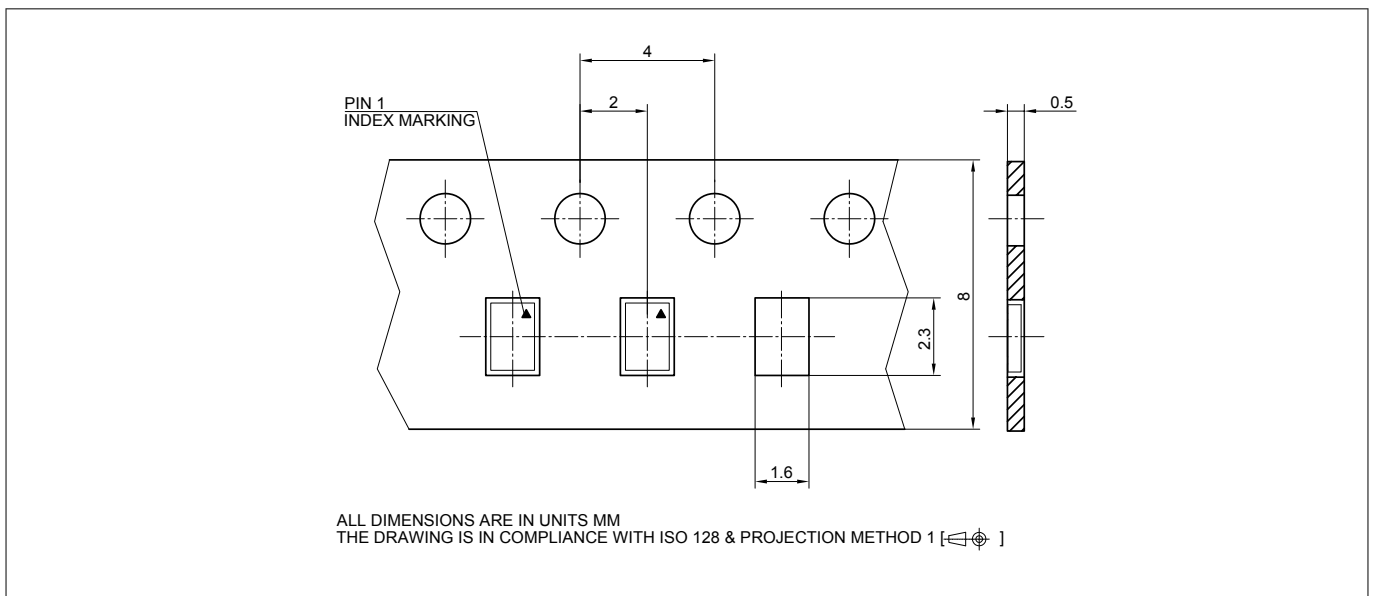

Figure 19 Tape information

Note: See our [Recommendations for Printed Circuit Board Assembly of TSLP/TSSLP/TSNP Packages](#). The marking layout is an example. For the real marking code refer to the device information on the first page. The number of characters shown in the layout example is not necessarily the real one. The marking layout can consist of less characters.

Revision history**Revision history**

Document version	Date of release	Description of changes
4.0	2018-09-26	New datasheet layout.

Trademarks

All referenced product or service names and trademarks are the property of their respective owners.

Edition 2018-09-26

Published by
Infineon Technologies AG
81726 Munich, Germany

© 2018 Infineon Technologies AG
All Rights Reserved.

Do you have a question about any
aspect of this document?
Email: erratum@infineon.com

Document reference
IFX-gza1502360740368

IMPORTANT NOTICE

The information given in this document shall in no event be regarded as a guarantee of conditions or characteristics ("Beschaffheitsgarantie").

With respect to any examples, hints or any typical values stated herein and/or any information regarding the application of the product, Infineon Technologies hereby disclaims any and all warranties and liabilities of any kind, including without limitation warranties of non-infringement of intellectual property rights of any third party.

In addition, any information given in this document is subject to customer's compliance with its obligations stated in this document and any applicable legal requirements, norms and standards concerning customer's products and any use of the product of Infineon Technologies in customer's applications.

The data contained in this document is exclusively intended for technically trained staff. It is the responsibility of customer's technical departments to evaluate the suitability of the product for the intended application and the completeness of the product information given in this document with respect to such application.

WARNINGS

Due to technical requirements products may contain dangerous substances. For information on the types in question please contact your nearest Infineon Technologies office.

Except as otherwise explicitly approved by Infineon Technologies in a written document signed by authorized representatives of Infineon Technologies, Infineon Technologies' products may not be used in any applications where a failure of the product or any consequences of the use thereof can reasonably be expected to result in personal injury

Mouser Electronics

Authorized Distributor

Click to View Pricing, Inventory, Delivery & Lifecycle Information:

[Infineon:](#)

[BGB707L7ESDE6327XTSA1](#)