

# BAT15-02LRH

## Single silicon RF Schottky diode



Order now



Technical documents



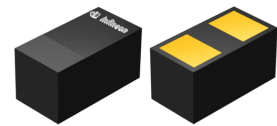
Simulation



Support

## Product description

This Infineon RF Schottky diode is a silicon low barrier N-type device with an integrated guard ring on-chip for over-voltage protection. Its low barrier height, low forward voltage and low junction capacitance make BAT15-02LRH a suitable choice for mixer and detector functions in applications which frequencies are as high as 12 GHz.



## Feature list

- Low inductance  $L_S = 0.4$  nH (typical)
- Low capacitance  $C = 0.2$  pF (typical) at 1 MHz
- TSLP-2-7 package (1 mm x 0.6 mm x 0.39 mm) with a 0402 foot print
- Pb-free, RoHS compliant and halogen-free

## Product validation

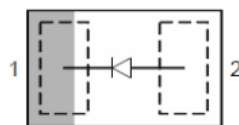
Qualified for industrial applications according to the relevant tests of JEDEC47/20/22.

## Potential applications

For mixer and detectors in:

- LiDAR systems
- Radar modules and systems

## Device information



**Table 1** Part information

Product name / Ordering code	Package	Pin configuration	Marking	Pieces/Reel
BAT15-02LRH / BAT1502LRHE6327XTSA1	TSLP-2-7	Single, leadless	NP	15 k

**Attention:** ESD (Electrostatic discharge) sensitive device, observe handling precautions!

**Table of contents**

**Table of contents**

	<b>Product description</b> .....	1
	<b>Feature list</b> .....	1
	<b>Product validation</b> .....	1
	<b>Potential applications</b> .....	1
	<b>Device information</b> .....	1
	<b>Table of contents</b> .....	2
<b>1</b>	<b>Absolute maximum ratings</b> .....	2
<b>2</b>	<b>Electrical performance in test fixture</b> .....	3
2.1	Electrical characteristics .....	3
2.2	Characteristic curves .....	4
<b>3</b>	<b>Thermal characteristics</b> .....	8
<b>4</b>	<b>Package information TSLP-2-7</b> .....	10
<b>5</b>	<b>References</b> .....	11
	<b>Revision history</b> .....	11
	<b>Disclaimer</b> .....	12

**1 Absolute maximum ratings**

**Table 2 Absolute maximum ratings at  $T_A = 25\text{ °C}$ , unless otherwise specified**

Parameter	Symbol	Values		Unit	Note or test condition
		Min.	Max.		
Diode reverse voltage	$V_R$	–	4	V	
Forward current	$I_F$	–	110	mA	
Total power dissipation	$P_{TOT}$	–	100	mW	$T_S \leq 84\text{ °C}$ <sup>1)</sup>
Junction temperature	$T_J$	–	150	°C	
Operating temperature	$T_{OP}$	-55	150		
Storage temperature	$T_{STG}$	-55	150		

**Attention:** *Stresses above the maximum values listed here may cause permanent damage to the device. Exposure to absolute maximum rating conditions for extended periods may affect device reliability. Exceeding only one of these values may cause irreversible damage to the component.*

<sup>1</sup>  $T_S$  is the soldering point temperature.

**Electrical performance in test fixture**

**2 Electrical performance in test fixture**

**2.1 Electrical characteristics**

**Table 3 Electrical characteristics at  $T_A = 25\text{ °C}$ , unless otherwise stated**

Parameter	Symbol	Values			Unit	Note or test condition
		Min.	Typ.	Max.		
Breakdown voltage	$V_{BR}$	4	–	–	V	$I_R = 100\ \mu\text{A}$
Reverse current	$I_R$	–	–	5	$\mu\text{A}$	$V_R = 1.5\ \text{V}$
		–	–	125		$V_R = 1.5\ \text{V}, T_A = 85\text{ °C}$ <sup>1)</sup>
Forward voltage	$V_F$	0.16	0.25	0.32	V	$I_F = 1\ \text{mA}$
		0.25	0.35	0.41		$I_F = 10\ \text{mA}$
Differential forward resistance	$R_F$	–	8	10	$\Omega$	$I_F = 10\ \text{mA} / 50\ \text{mA}$ <sup>2)</sup>
Capacitance	C	–	0.2	0.24	pF	$V_R = 0\ \text{V}, f = 1\ \text{MHz}$
Series inductance	$L_S$	–	0.4	0.6	nH	<sup>1)</sup>

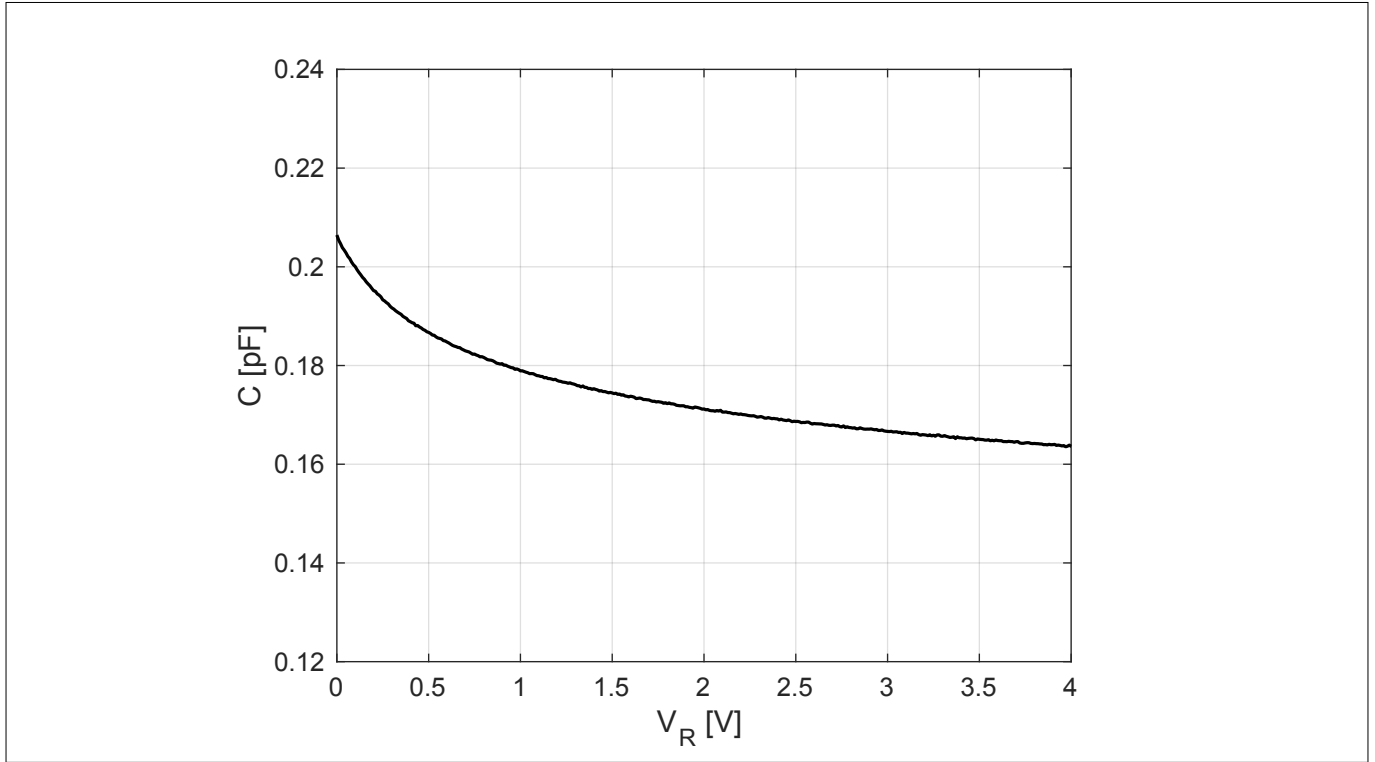
<sup>1</sup> Parameter is not subject to production test, min/max values are specified by design.

<sup>2</sup> 
$$R_F = \frac{V_F(50\ \text{mA}) - V_F(10\ \text{mA})}{50\ \text{mA} - 10\ \text{mA}}$$

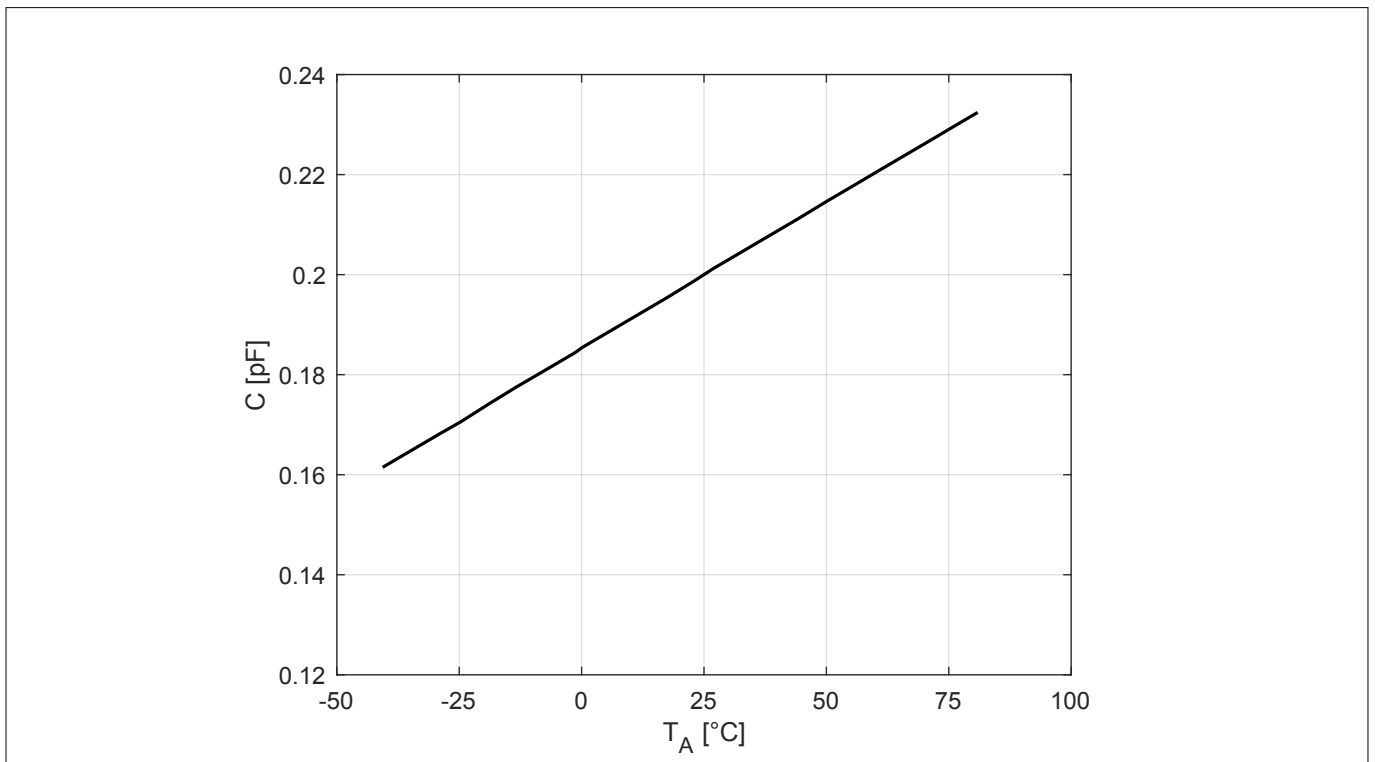
**Electrical performance in test fixture**

**2.2 Characteristic curves**

At  $T_A = 25\text{ °C}$ , unless otherwise stated

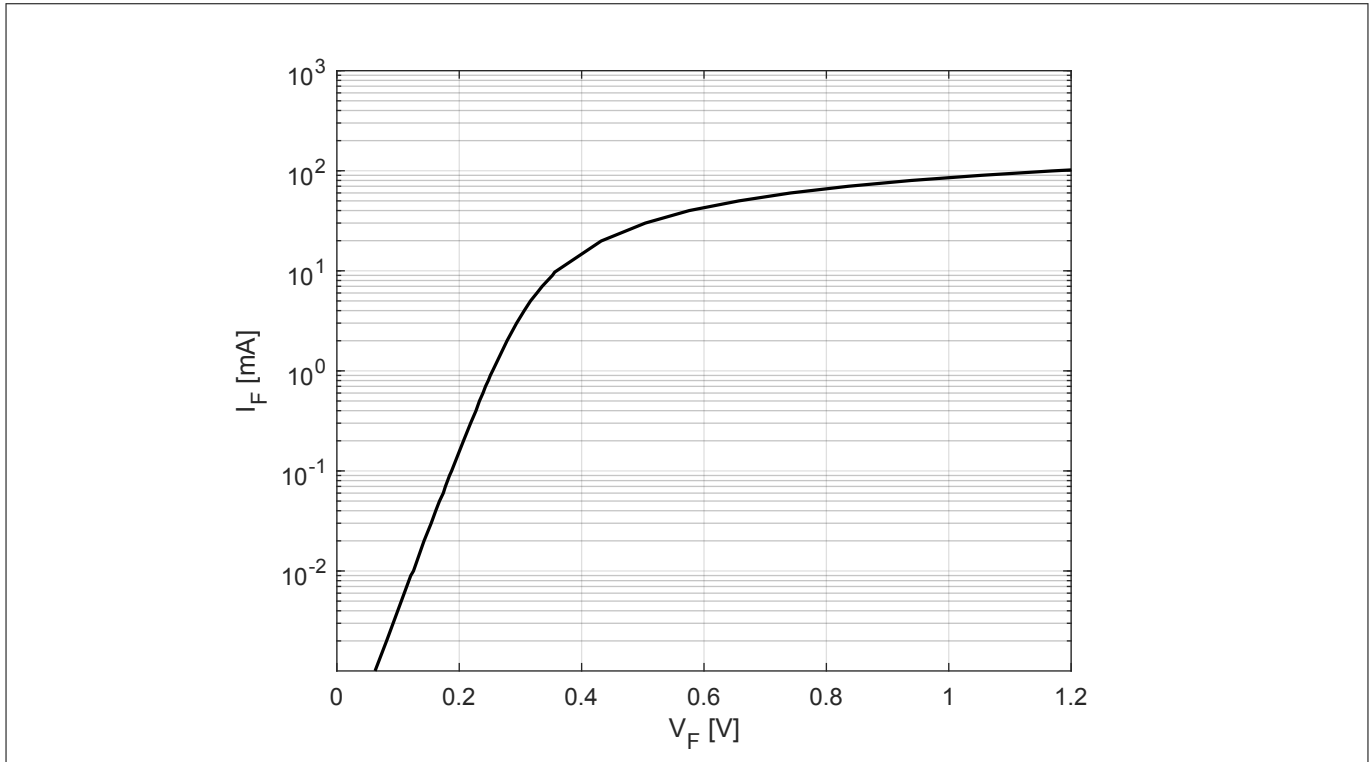


**Figure 1** Capacitance  $C$  vs. reverse voltage  $V_R$  at frequency  $f = 1\text{ MHz}$

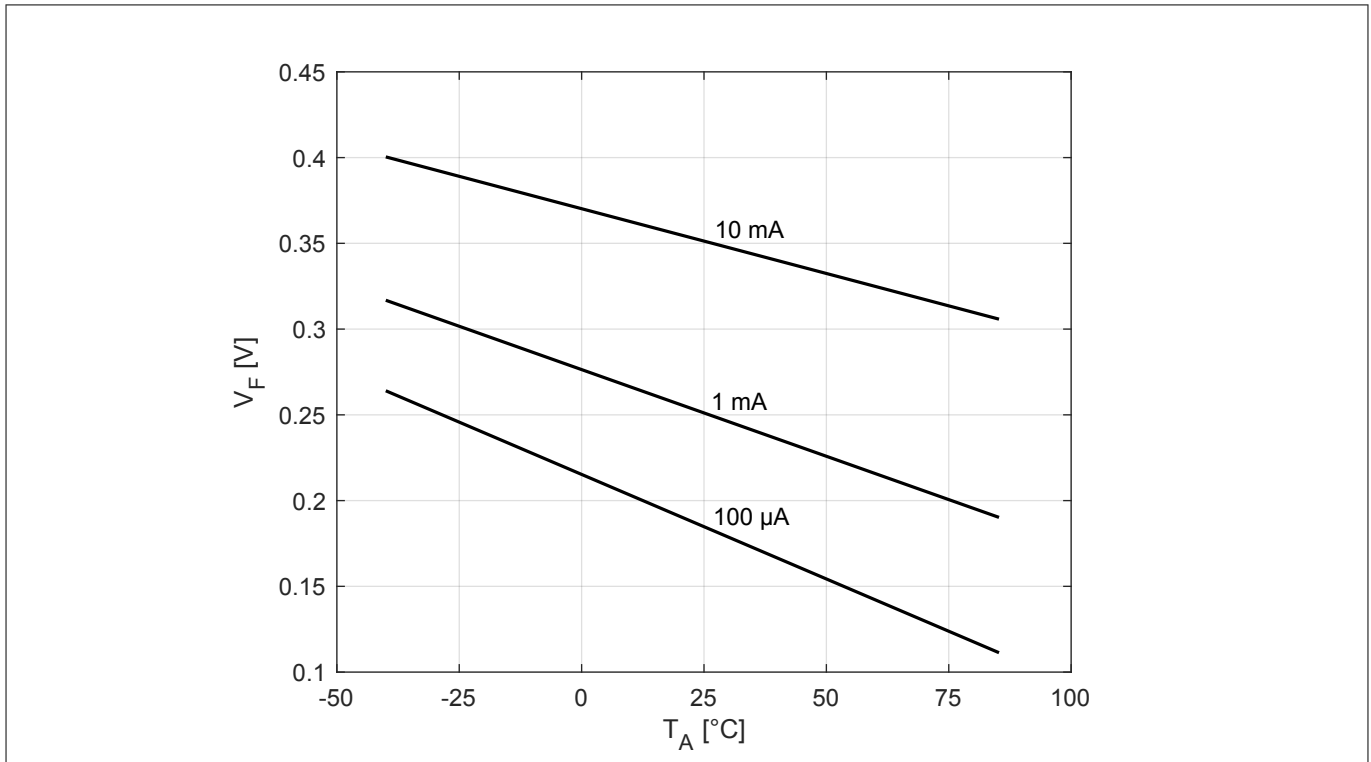


**Figure 2** Capacitance  $C$  vs. ambient temperature  $T_A$  at a frequency  $f = 1\text{ MHz}$  at reverse voltage  $V_R = 0\text{ V}$

**Electrical performance in test fixture**

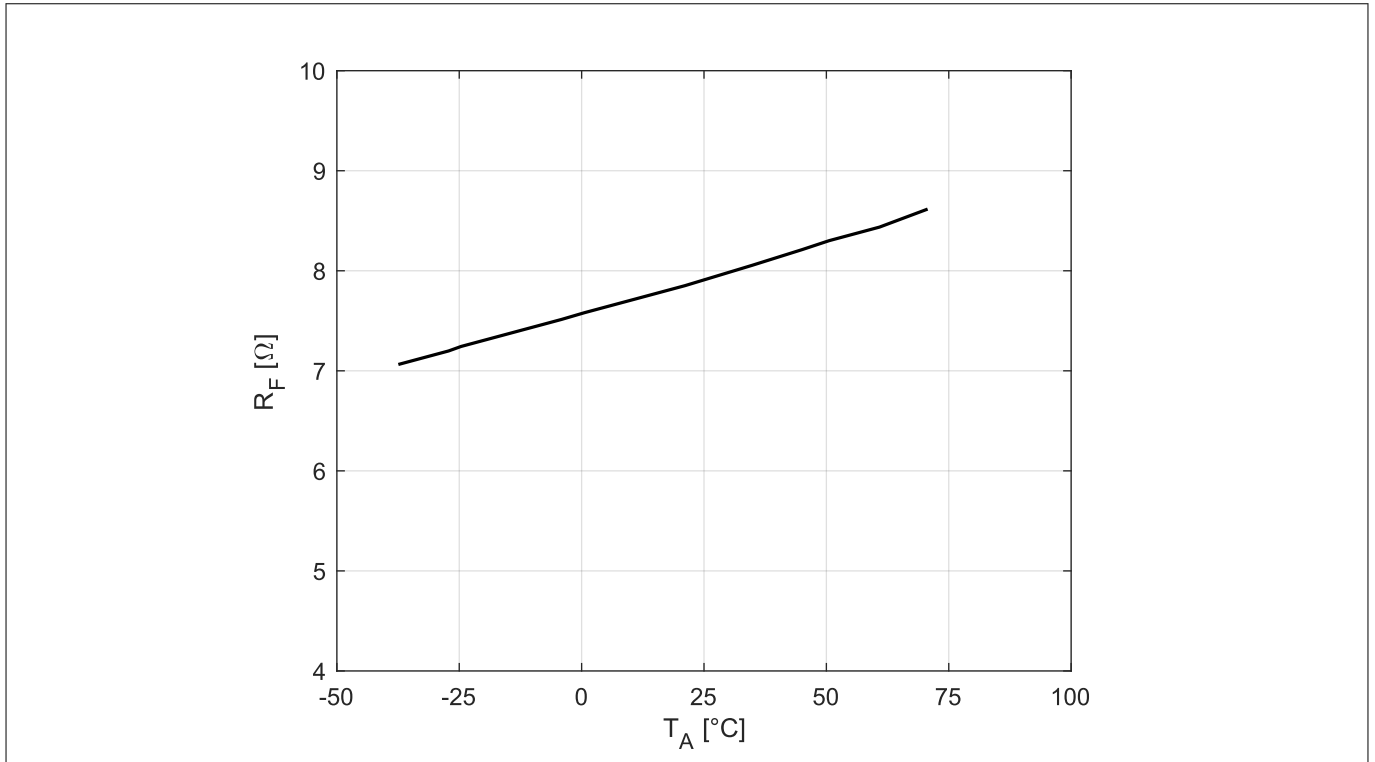


**Figure 3** Forward current  $I_F$  vs. forward voltage  $V_F$

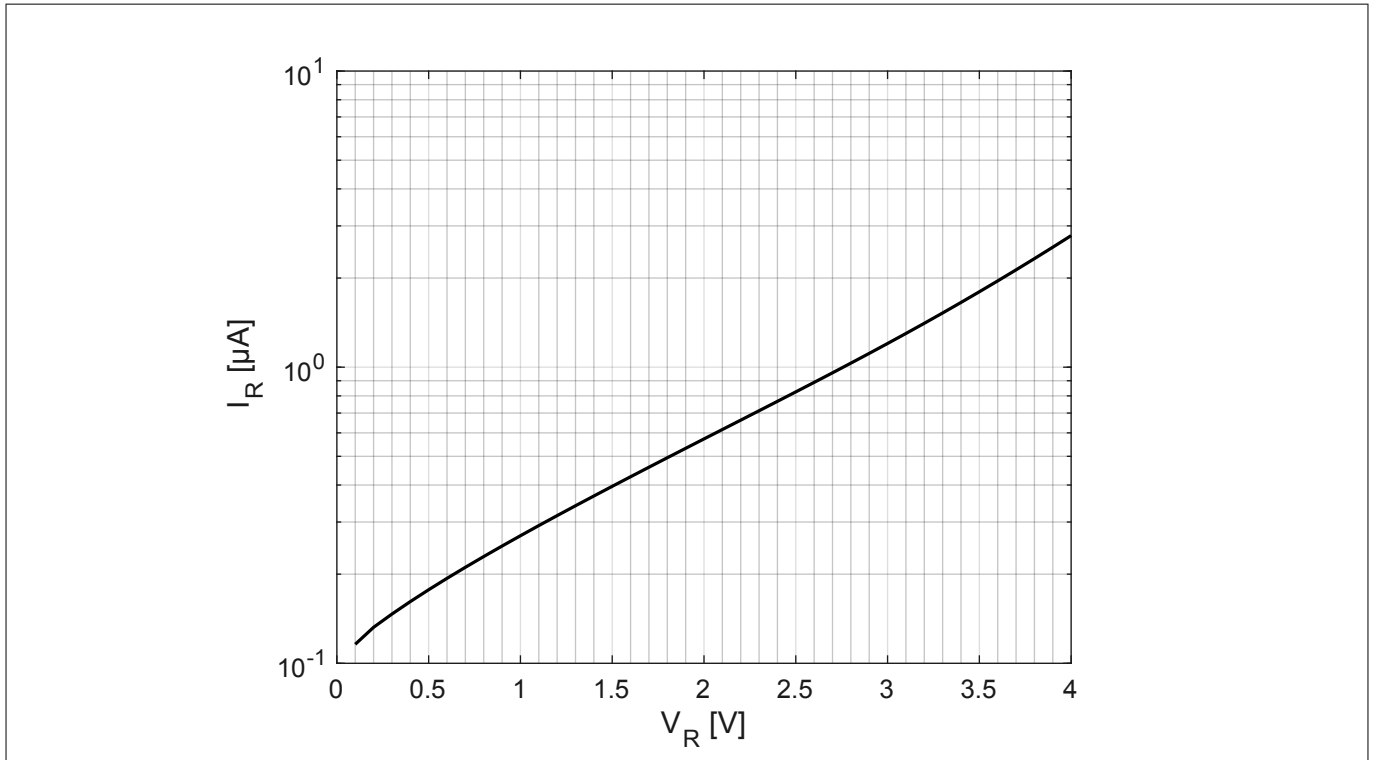


**Figure 4** Forward voltage  $V_F$  vs. ambient temperature  $T_A$  at forward currents  $I_F = 100 \mu\text{A}$ , 1 mA and 10 mA

**Electrical performance in test fixture**

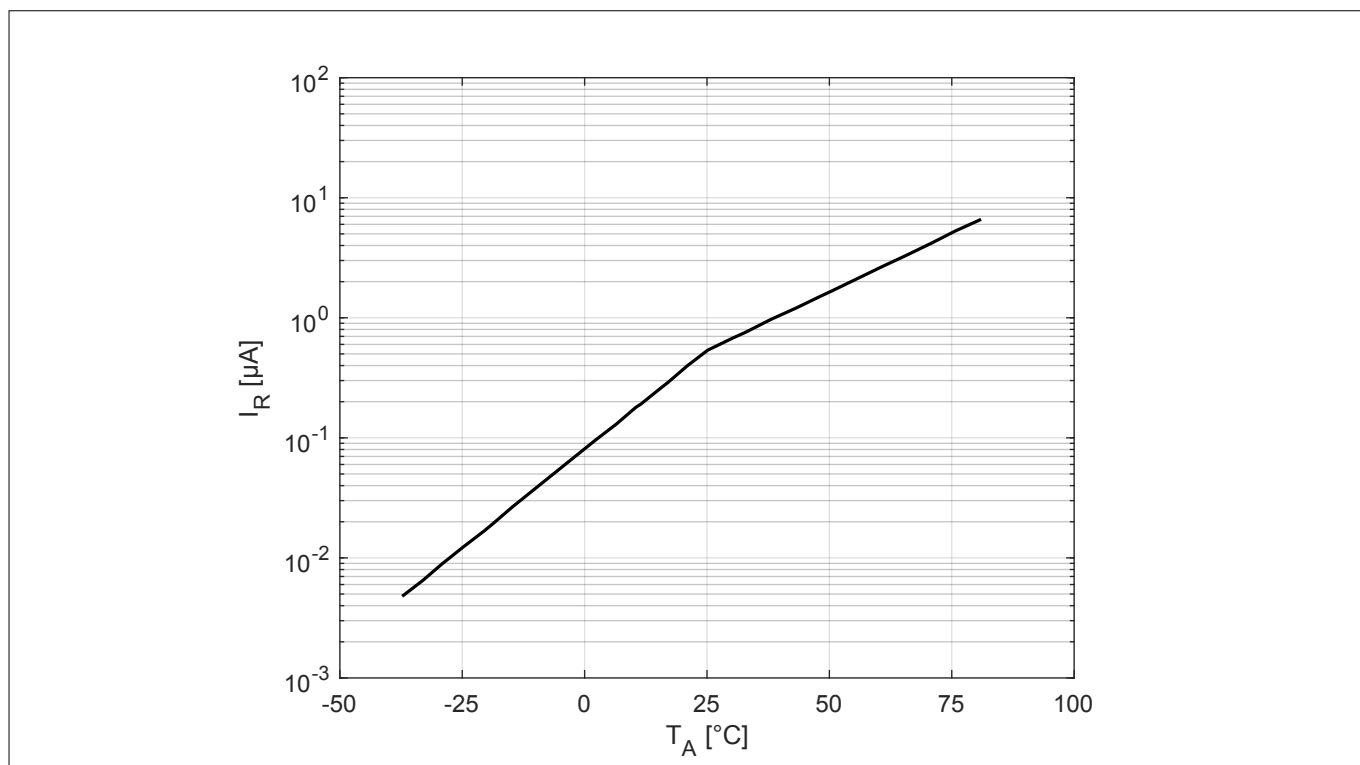


**Figure 5** Differential forward resistance  $R_F$  vs. ambient temperature  $T_A$  between forward currents  $I_F = 10$  mA and 50 mA



**Figure 6** Reverse current  $I_R$  vs. reverse voltage  $V_R$

**Electrical performance in test fixture**



**Figure 7** Reverse current  $I_R$  vs. ambient temperature  $T_A$  at reverse voltage  $V_R = 1$  V

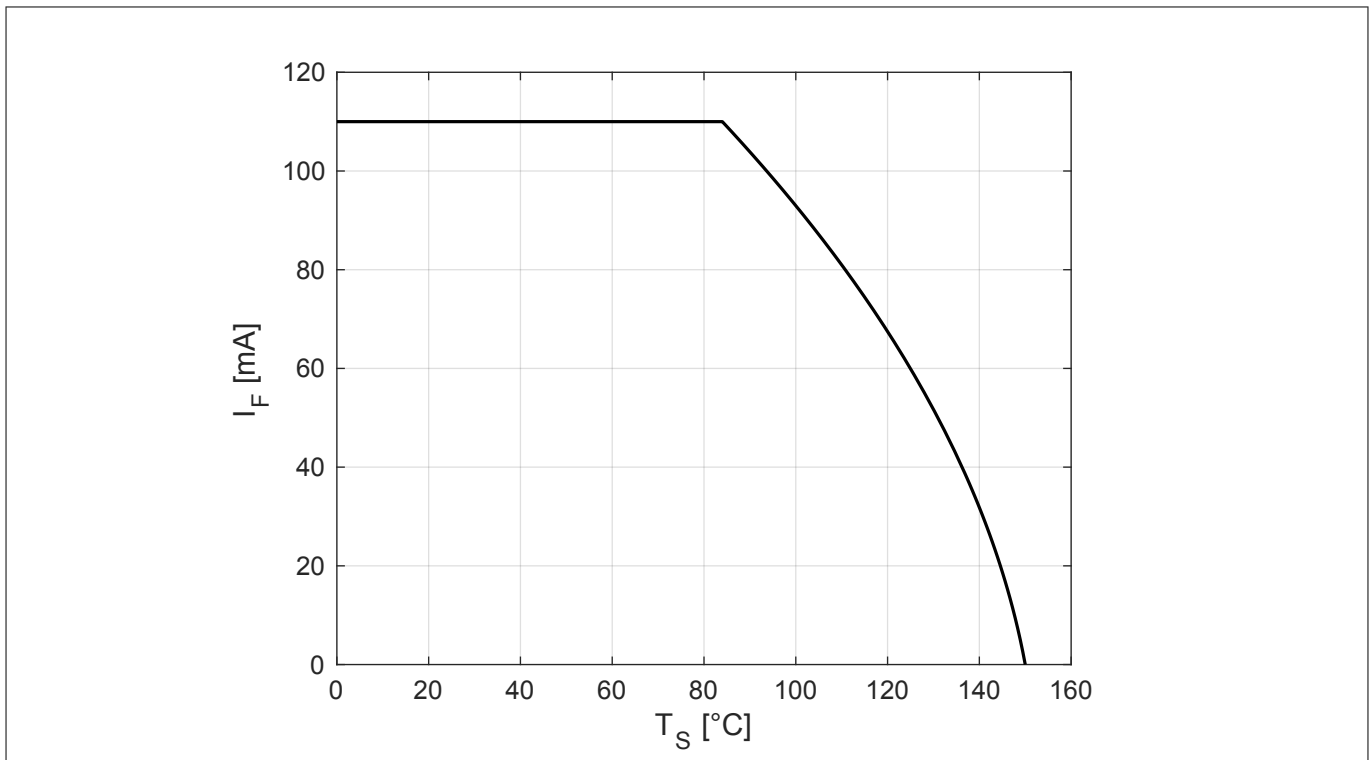
*Note:* The curves shown in this chapter have been generated using typical devices but shall not be understood as a guarantee that all devices have identical characteristic curves.

**Thermal characteristics**

**3 Thermal characteristics**

**Table 4 Thermal resistance**

Parameter	Symbol	Values			Unit	Note or Test Condition
		Min.	Typ.	Max.		
Thermal resistance (junction - soldering point)	$R_{thJS}$	–	660	–	K/W	$T_S = 84^\circ\text{C}$ <sup>1)</sup>

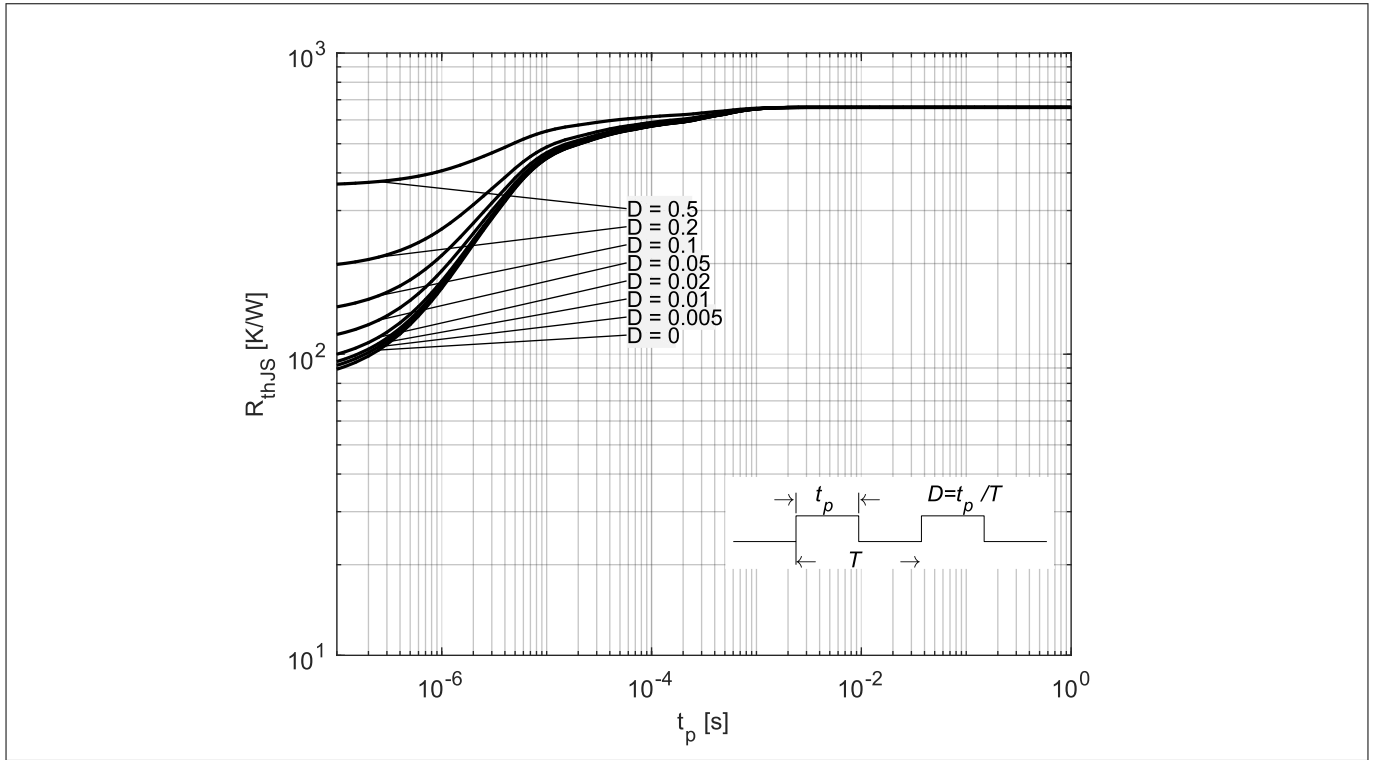


**Figure 8 Permissible forward current  $I_F$  in DC operation**

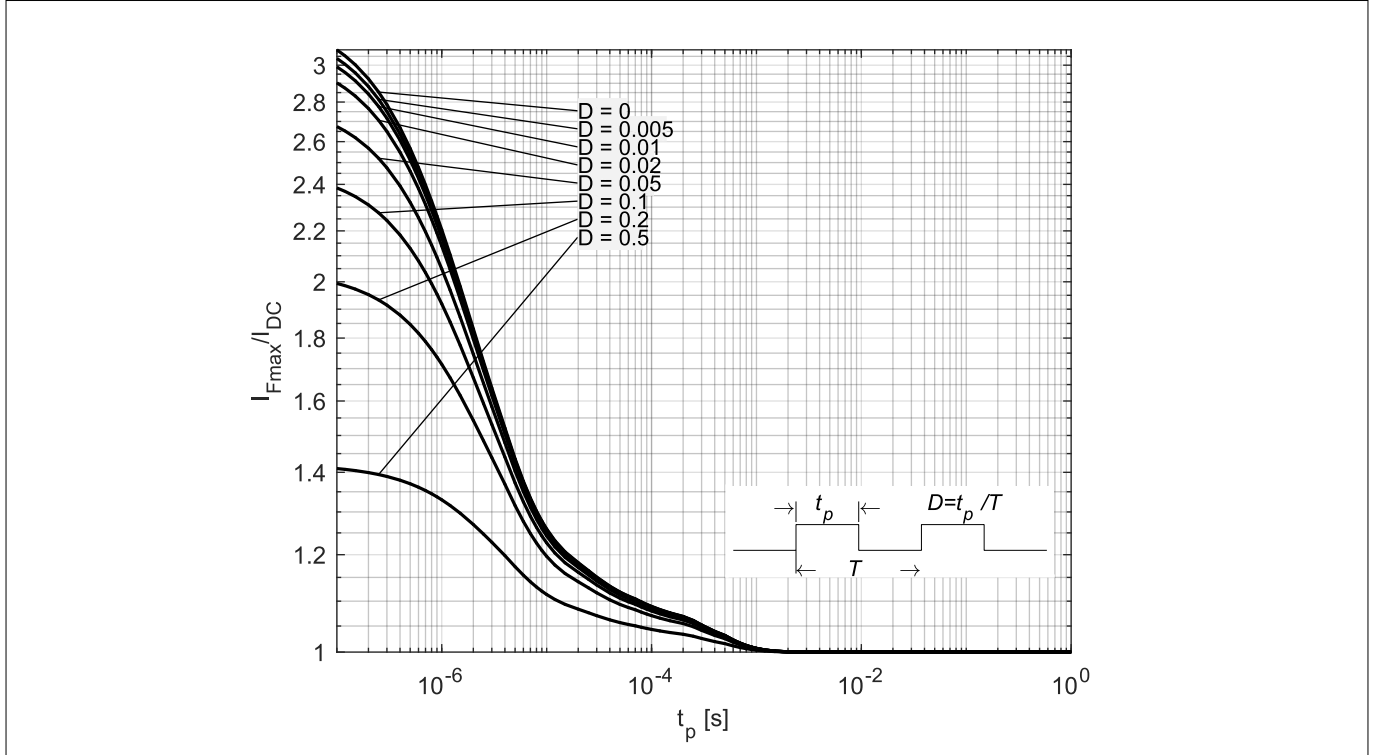
<sup>1</sup> For  $R_{thJS}$  in other conditions refer to the curves in this chapter.



**Thermal characteristics**

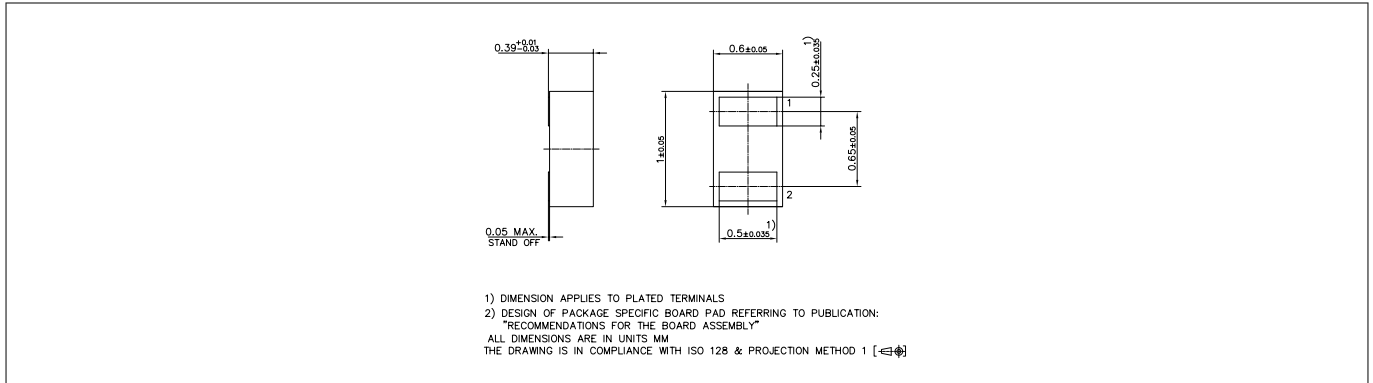


**Figure 9 Thermal resistance  $R_{thJS}$  in pulse operation**

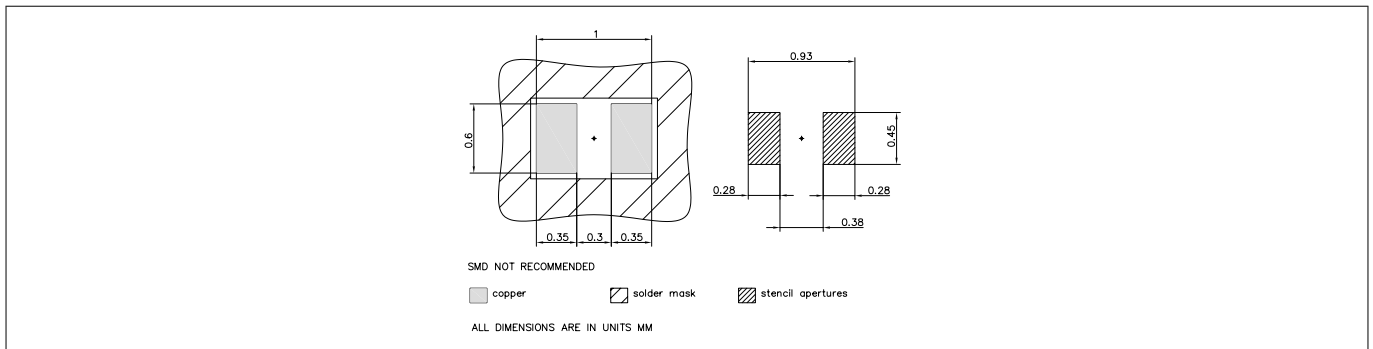


**Figure 10 Permissible forward current ratio  $I_{Fmax}/I_{DC}$  in pulse operation**

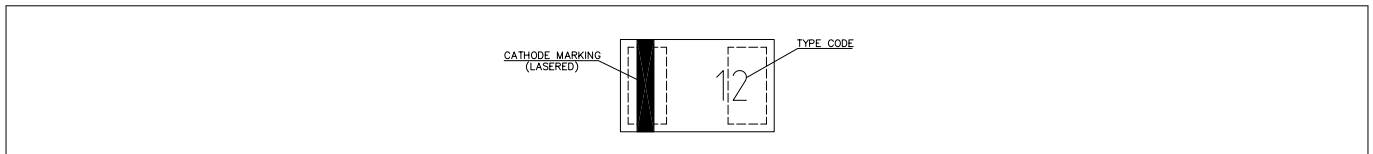
## 4 Package information TSLP-2-7



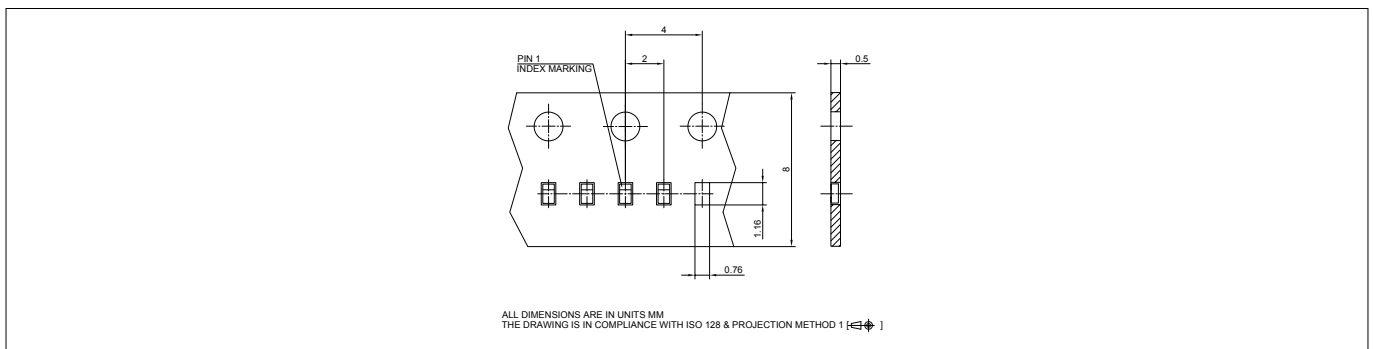
**Figure 11** Package outline



**Figure 12** Foot print



**Figure 13** Marking layout example



**Figure 14** Tape information

Note: See our [Recommendations for Printed Circuit Board Assembly of TSLP/TSSLP/TSNP Packages](#). The marking layout is an example. For the real marking code refer to the device information on the first page. The number of characters shown in the layout example is not necessarily the real one. The marking layout can consist of less characters.

---

References

## 5 References

---

[1]	Infineon AG - <a href="#">Recommendations for Printed Circuit Board Assembly of Infineon TSLP/TSSLP/TSNP Packages</a>
-----	---

---

## Revision history

Document version	Date of release	Description of changes
2.0	2018-09-07	<ul style="list-style-type: none"><li>• New layout of datasheet</li><li>• Typical values and curves updated to the values of the production (No product or process change behind)</li></ul>

## Trademarks

All referenced product or service names and trademarks are the property of their respective owners.

**Edition 2018-06-30**

**Published by**  
**Infineon Technologies AG**  
**81726 Munich, Germany**

**© 2018 Infineon Technologies AG**  
**All Rights Reserved.**

**Do you have a question about any**  
**aspect of this document?**  
**Email: [erratum@infineon.com](mailto:erratum@infineon.com)**

**Document reference**  
**IFX-naw1514902894679**

## IMPORTANT NOTICE

The information given in this document shall in no event be regarded as a guarantee of conditions or characteristics ("Beschaffheitsgarantie").

With respect to any examples, hints or any typical values stated herein and/or any information regarding the application of the product, Infineon Technologies hereby disclaims any and all warranties and liabilities of any kind, including without limitation warranties of non-infringement of intellectual property rights of any third party.

In addition, any information given in this document is subject to customer's compliance with its obligations stated in this document and any applicable legal requirements, norms and standards concerning customer's products and any use of the product of Infineon Technologies in customer's applications.

The data contained in this document is exclusively intended for technically trained staff. It is the responsibility of customer's technical departments to evaluate the suitability of the product for the intended application and the completeness of the product information given in this document with respect to such application.

## WARNINGS

Due to technical requirements products may contain dangerous substances. For information on the types in question please contact your nearest Infineon Technologies office.

Except as otherwise explicitly approved by Infineon Technologies in a written document signed by authorized representatives of Infineon Technologies, Infineon Technologies' products may not be used in any applications where a failure of the product or any consequences of the use thereof can reasonably be expected to result in personal injury

# Mouser Electronics

Authorized Distributor

Click to View Pricing, Inventory, Delivery & Lifecycle Information:

[Infineon:](#)

[BAT1502LRHE6327XTSA1](#)