

## IR MOSFET-DirectFET™

IRF7749L1TRPbF

Quality Requirement Category: Industrial

### Applications

- RoHS Compliant, Halogen Free
- Lead-Free (Qualified up to 260°C Reflow)
- Ideal for High Performance Isolated Converter Primary Switch Socket
- Optimized for Synchronous Rectification
- Low Conduction Losses
- High Cdv/dt Immunity
- Low Profile (<0.7mm)
- Dual Sided Cooling Compatible
- Compatible with existing Surface Mount Techniques

DirectFET™ N-Channel Power MOSFET

<b>V<sub>DSS</sub></b>	<b>60V</b>
<b>R<sub>DS(on)</sub> typ. @ V<sub>GS</sub> = 10V</b>	<b>1.1mΩ</b>
<b>R<sub>DS(on)</sub> max @ V<sub>GS</sub> = 10V</b>	<b>1.5mΩ</b>
<b>I<sub>D</sub> (Silicon Limited)</b>	<b>345A ⑦</b>
<b>I<sub>D</sub> (Package Limited)</b>	<b>375A ①</b>

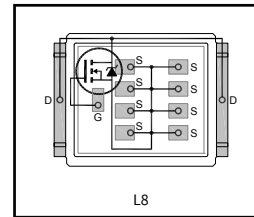

<b>G</b>	<b>D</b>	<b>S</b>
Gate	Drain	Source

Base part number	Package Type	Standard Pack		Orderable Part Number
		Form	Quantity	
IRF7749L1TRPbF	DirectFET™ Large Can (LA)	Tape and Reel	4000	IRF7749L1TRPbF

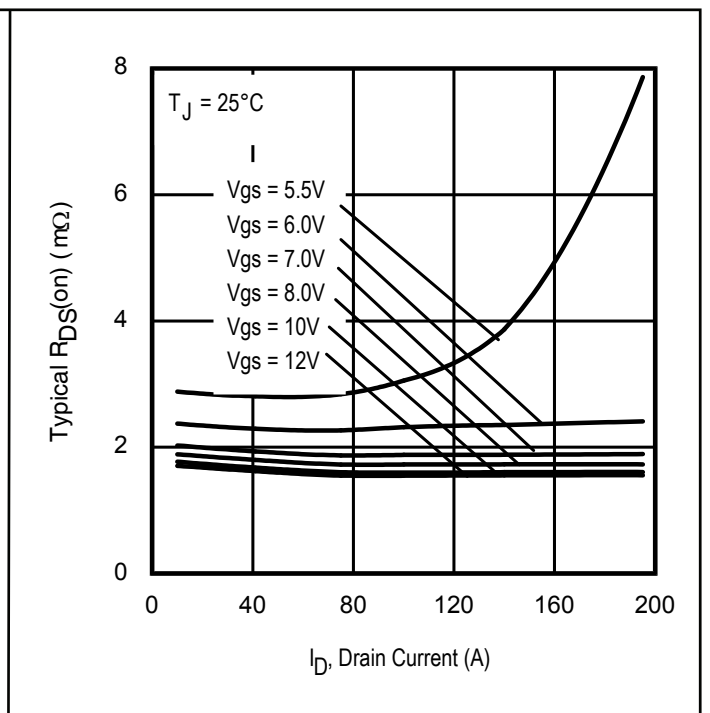
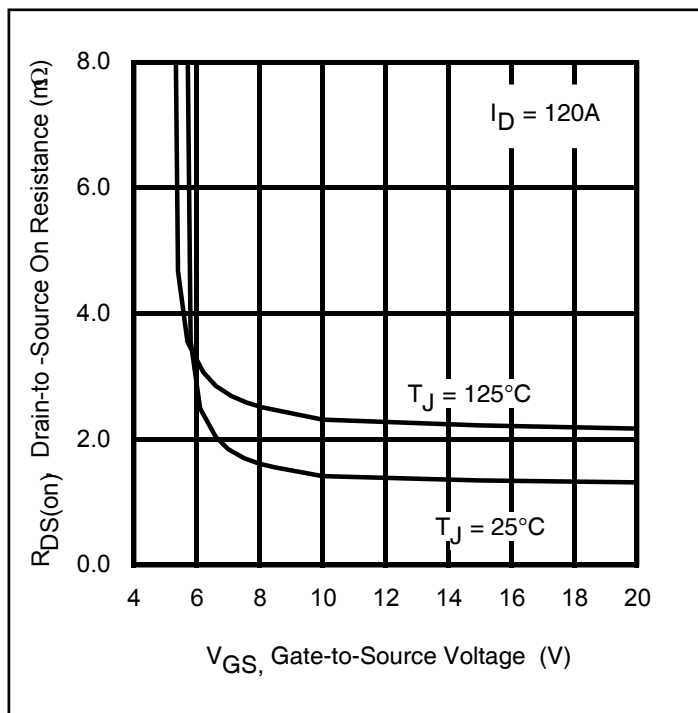

Figure 1 Typical On-Resistance vs. Gate Voltage

Figure 2 Typical On-Resistance vs. Drain Current

**Table of Contents**

**Applications .....1**

**Ordering Table .....1**

**Table of Contents .....2**

**1 Parameters .....3**

**2 Maximum ratings, Thermal, and Avalanche characteristics .....4**

**3 Electrical characteristics .....5**

**4 Electrical characteristic diagrams .....6**

**Package Information .....14**

**Qualification Information .....16**

**Revision History .....17**

# 1 Parameters

**Table1 Key performance parameters**

Parameter	Values	Units
$V_{DS}$	60	V
$R_{DS(on) max}$	1.5	m $\Omega$
$I_D @ T_C$	345 	A
$I_D @ T_A$	36	A

## 2 Maximum ratings and thermal characteristics

**Table 2 Maximum ratings (at  $T_J=25^\circ\text{C}$ , unless otherwise specified)**

Parameter	Symbol	Conditions	Values	Unit
Continuous Drain Current (Silicon Limited) ④	$I_D$	$T_C = 25^\circ\text{C}, V_{GS} @ 10\text{V}$	345 ⑦	A
Continuous Drain Current (Silicon Limited) ④	$I_D$	$T_C = 100^\circ\text{C}, V_{GS} @ 10\text{V}$	243	
Continuous Drain Current (Silicon Limited) ①	$I_D$	$T_A = 25^\circ\text{C}, V_{GS} @ 10\text{V}$	36	
Continuous Drain Current (Package Limited) ④	$I_D$	$T_C = 25^\circ\text{C}, V_{GS} @ 10\text{V}$	375 ①	
Pulsed Drain Current ②	$I_{DM}$	$T_C = 25^\circ\text{C}$	1380	W
Maximum Power Dissipation	$P_D$	$T_C = 25^\circ\text{C}$	341	
Maximum Power Dissipation	$P_D$	$T_A = 25^\circ\text{C}$	3.8	W/°C
Linear Derating Factor	-	-	0.025	V
Gate-to-Source Voltage	$V_{GS}$	-	$\pm 20$	°C
Operating Junction	$T_J$	-	-55 to +175	
Storage Temperature Range	$T_{STG}$	-		

**Table 3 Thermal characteristics**

Parameter	Symbol	Conditions	Min.	Typ.	Max.	Unit
Junction-to-Ambient ①	$R_{\theta JA}$	-	-	-	40	°C/W
Junction-to-Ambient ③	$R_{\theta JA}$	-	-	12.5	-	
Junction-to-Ambient ②	$R_{\theta JA}$	-	-	20	-	
Junction-to-Case ④ ⑥	$R_{\theta JC}$	-	-	-	0.44	
Junction-to-PCB Mounted	$R_{\theta JA-PCB}$	-	-	-	0.5	

**Table 4 Avalanche characteristics**

Parameter	Symbol	Values	Unit
Single Pulse Avalanche Energy (Thermally Limited) ③	$E_{AS}$	315	mJ
Single Pulse Avalanche Energy (Tested) ③	$E_{AS}$	714	
Avalanche Current ②	$I_{AR}$	See Fig.15,16, 19a, 19b	A
Repetitive Avalanche Energy ②	$E_{AR}$		mJ

**Notes:**

- ① Package limit current based on source connection technology
- ② Repetitive rating; pulse width limited by max. junction temperature.
- ③ Limited by  $T_{Jmax}$ , starting  $T_J = 25^\circ\text{C}$ ,  $L = 0.044\text{mH}$ ,  $R_G = 50\Omega$ ,  $I_{AS} = 120\text{A}$ ,  $V_{GS} = 10\text{V}$ .
- ④ Pulse width  $\leq 400\mu\text{s}$ ; duty cycle  $\leq 2\%$ .
- ⑤  $C_{oss}$  eff. (TR) is a fixed capacitance that gives the same charging time as  $C_{oss}$  while  $V_{DS}$  is rising from 0 to 80%  $V_{DSS}$ .
- ⑥  $R_\theta$  is measured at  $T_J$  approximately  $90^\circ\text{C}$ .
- ⑦ Silicon limit current based on maximum allowable junction temperature  $T_{Jmax}$ .

### 3 Electrical characteristics

**Table 5 Static characteristics**

Parameter	Symbol	Conditions	Values			Unit
			Min.	Typ.	Max.	
Drain-to-Source Breakdown Voltage	$V_{(BR)DSS}$	$V_{GS} = 0V, I_D = 250\mu A$	60	-	-	V
Breakdown Voltage Temp. Coefficient	$\Delta V_{(BR)DSS}/\Delta T_J$	Reference to 25°C, $I_D = 3.0mA$	-	56	-	mV/°C
Static Drain-to-Source On-Resistance	$R_{DS(on)}$	$V_{GS} = 10V, I_D = 120A$	-	1.1	1.5	mΩ
Gate Threshold Voltage	$V_{GS(th)}$	$V_{DS} = V_{GS}, I_D = 250\mu A$	2.0	-	4.0	V
Gate Threshold Voltage Coefficient	$\Delta V_{GS(th)}/\Delta T_J$		-	8.8	-	mV/°C
Drain-to-Source Leakage Current	$I_{DSS}$	$V_{DS} = 60V, V_{GS} = 0V$	-	-	20	μA
		$V_{DS} = 60V, V_{GS} = 0V, T_J = 125^\circ C$	-	-	250	
Gate-to-Source Forward Leakage	$I_{GSS}$	$V_{GS} = 20V$	-	-	100	nA
	$I_{GSS}$	$V_{GS} = -20V$	-	-	100	
Gate Resistance	$R_G$	-	-	1.5	-	Ω

**Table 6 Dynamic characteristics**

Parameter	Symbol	Conditions	Values			Unit
			Min.	Typ.	Max.	
Forward Trans conductance	gfs	$V_{DS} = 10V, I_D = 120A$	185	-	-	S
Total Gate Charge	$Q_g$	$I_D = 120A$ $V_{DS} = 30V$ $V_{GS} = 10V$ ④	-	183	275	nC
Gate-to-Source Charge	$Q_{gs1}$		-	39	-	
Gate-to-Source Charge	$Q_{gs2}$		-	19	-	
Gate-to-Drain ("Miller) Charge	$Q_{gd}$		-	46	-	
Gate Charge Overdrive	$Q_{godr}$		-	79	-	
Switch Charge ( $Q_{gs2} + Q_{gd}$ )	$Q_{sw}$		-	65	-	
Output Charge	$Q_{oss}$	$V_{DS} = 48V, V_{GS} = 0V$	-	119	-	nC
Turn-On Delay Time	$t_{d(on)}$	$V_{DD} = 30V$	-	29	-	ns
Rise Time	$t_r$	$I_D = 120A$	-	149	-	
Turn-Off Delay Time	$t_{d(off)}$	$R_G = 1.8\Omega$	-	72	-	
Fall Time	$t_f$	$V_{GS} = 10V$ ④	-	88	-	
Input Capacitance	$C_{iss}$	$V_{GS} = 0V$	-	10655	-	pF
Output Capacitance	$C_{oss}$	$V_{DS} = 25V$	-	1627	-	
Reverse Transfer Capacitance	$C_{rss}$	$f = 1.0MHz$	-	680	-	
Effective Output Capacitance	$C_{oss\ eff.}$	$V_{GS} = 0V, V_{DS} = 0V\ to\ 48V$ ⑤	-	1959	-	

**Table 7 Reverse Diode**

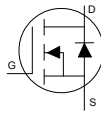
Parameter	Symbol	Conditions	Values			Unit
			Min.	Typ.	Max.	
Continuous Source Current (Body Diode)	$I_S$	MOSFET symbol showing the integral reverse p-n junction diode. 	-	-	345	A
Pulsed Source Current (Body Diode) ②	$I_{SM}$		-	-	1380	
Diode Forward Voltage	$V_{SD}$	$T_J = 25^\circ C, I_S = 120A, V_{GS} = 0V$ ④	-	-	1.3	V
Reverse Recovery Time	$t_{rr}$	$T_J = 25^\circ C, I_F = 120A,$	-	42	-	ns
Reverse Recovery Charge	$Q_{rr}$	$V_{DD} = 30V, di/dt = 100A/\mu s$ ④	-	54	-	nC

### 4 Electrical characteristic diagrams

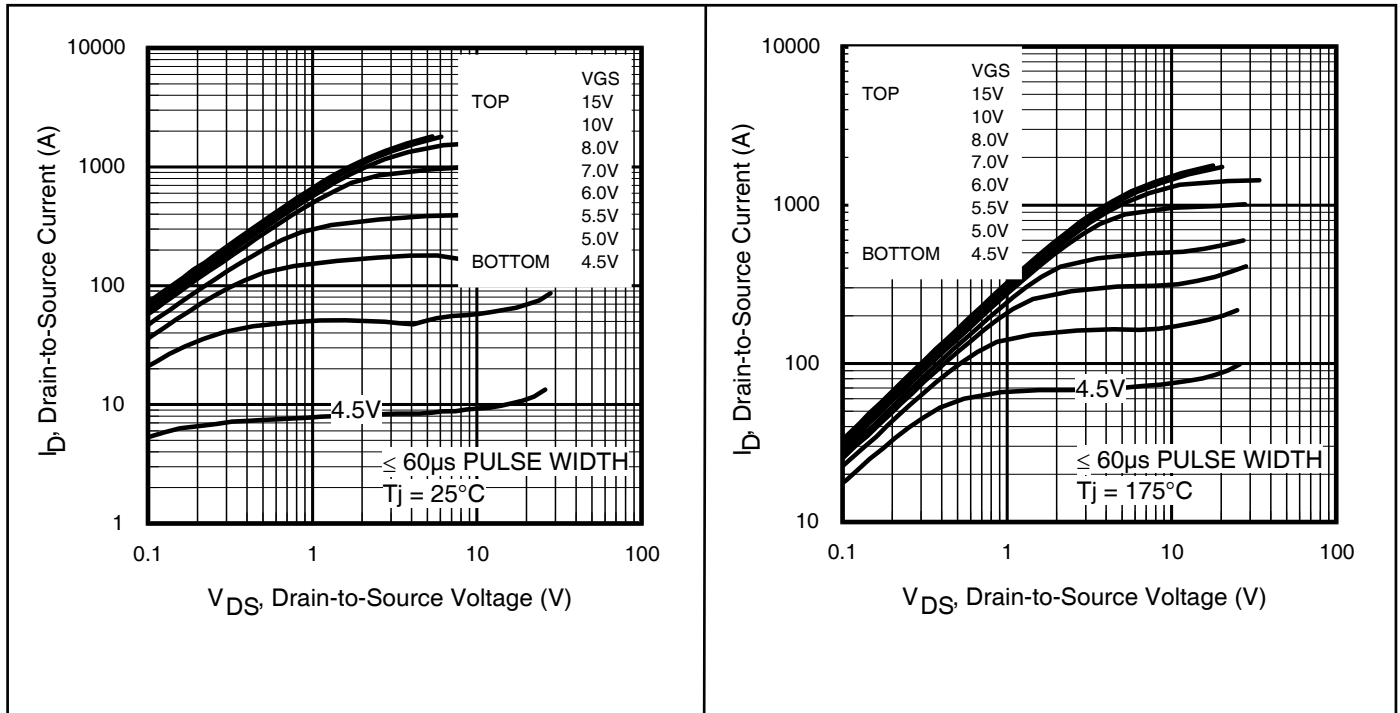

Figure 3 Typical Output Characteristics

Figure 4 Typical Output Characteristics

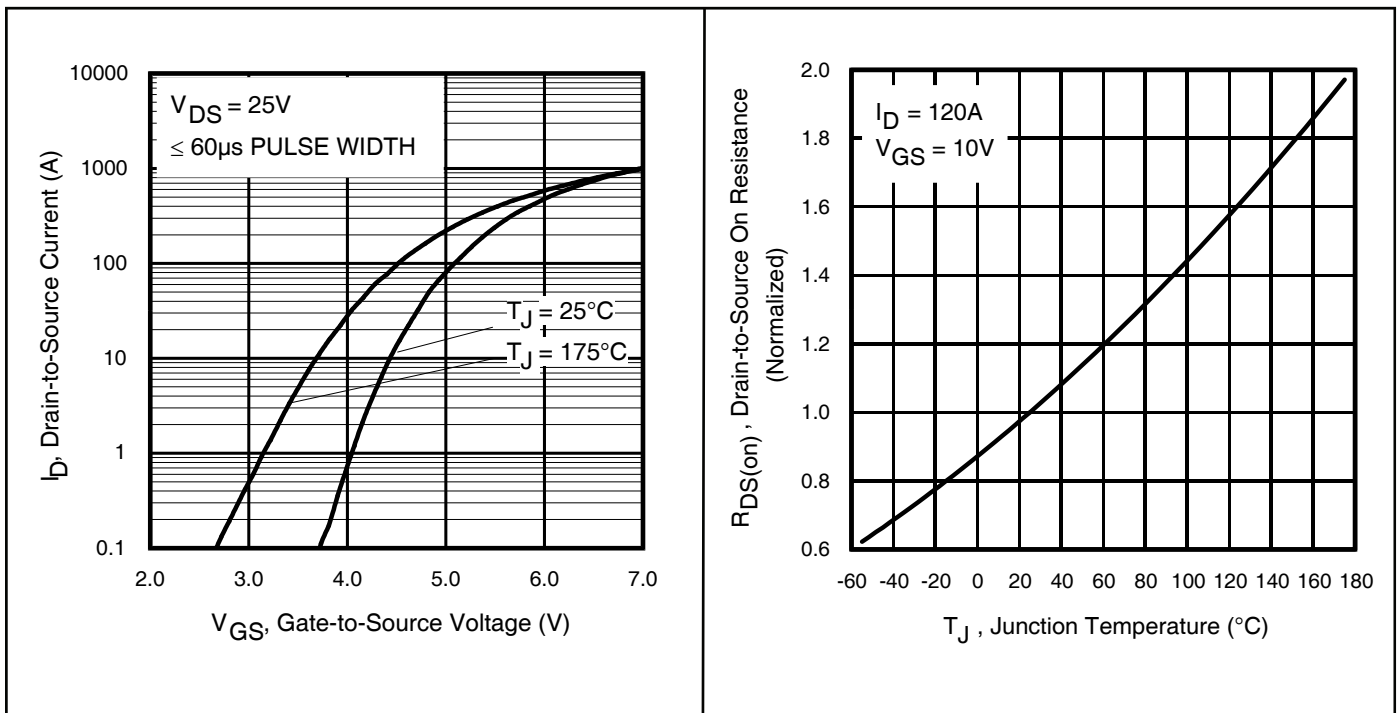

Figure 5 Typical Transfer Characteristics

Figure 6 Normalized On-Resistance vs. Temperature

Electrical characteristic diagrams

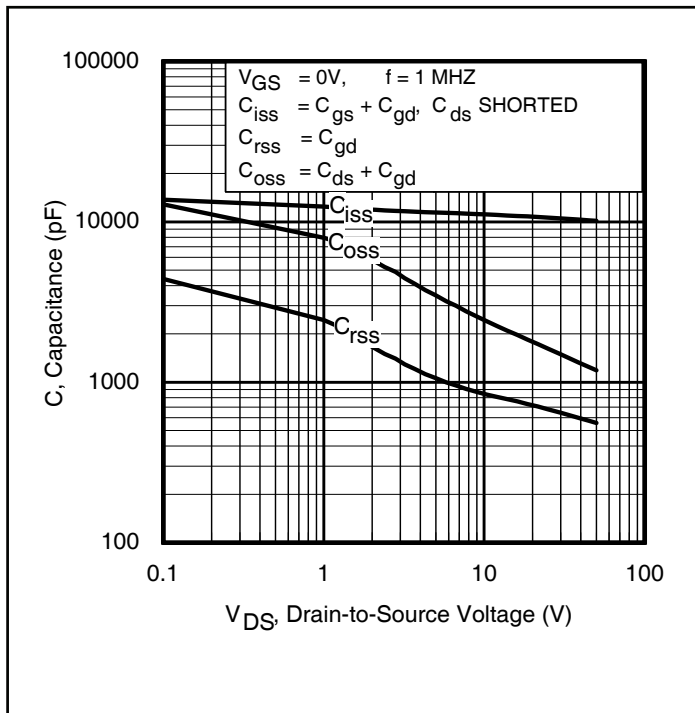

Figure 7 Typical Capacitance vs. Drain-to-Source Voltage

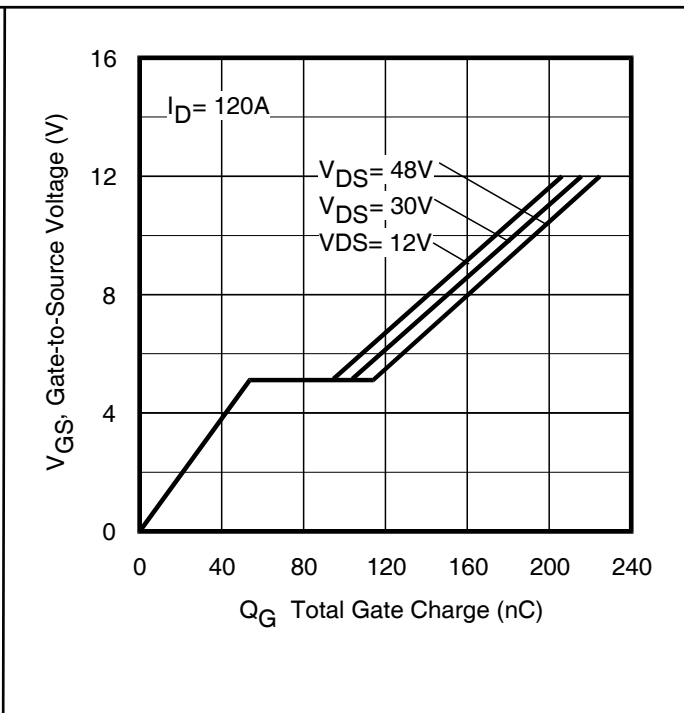

Figure 8 Typical Gate Charge vs. Gate-to-Source Voltage

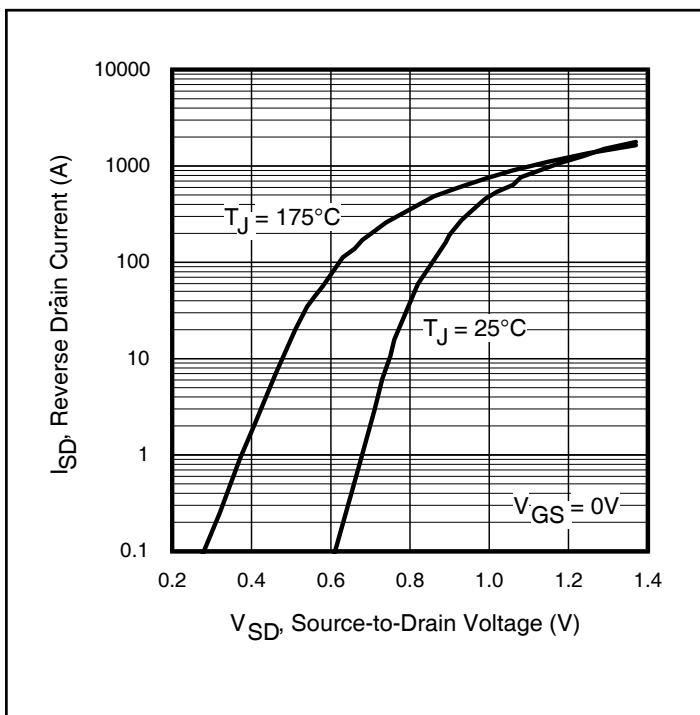

Figure 9 Typical Source-Drain Diode Forward Voltage

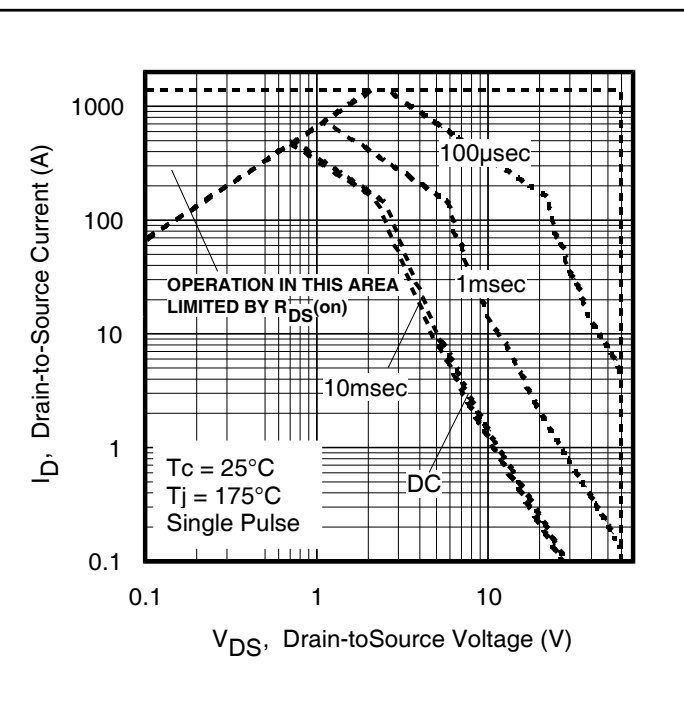

Figure 10 Maximum Safe Operating Area

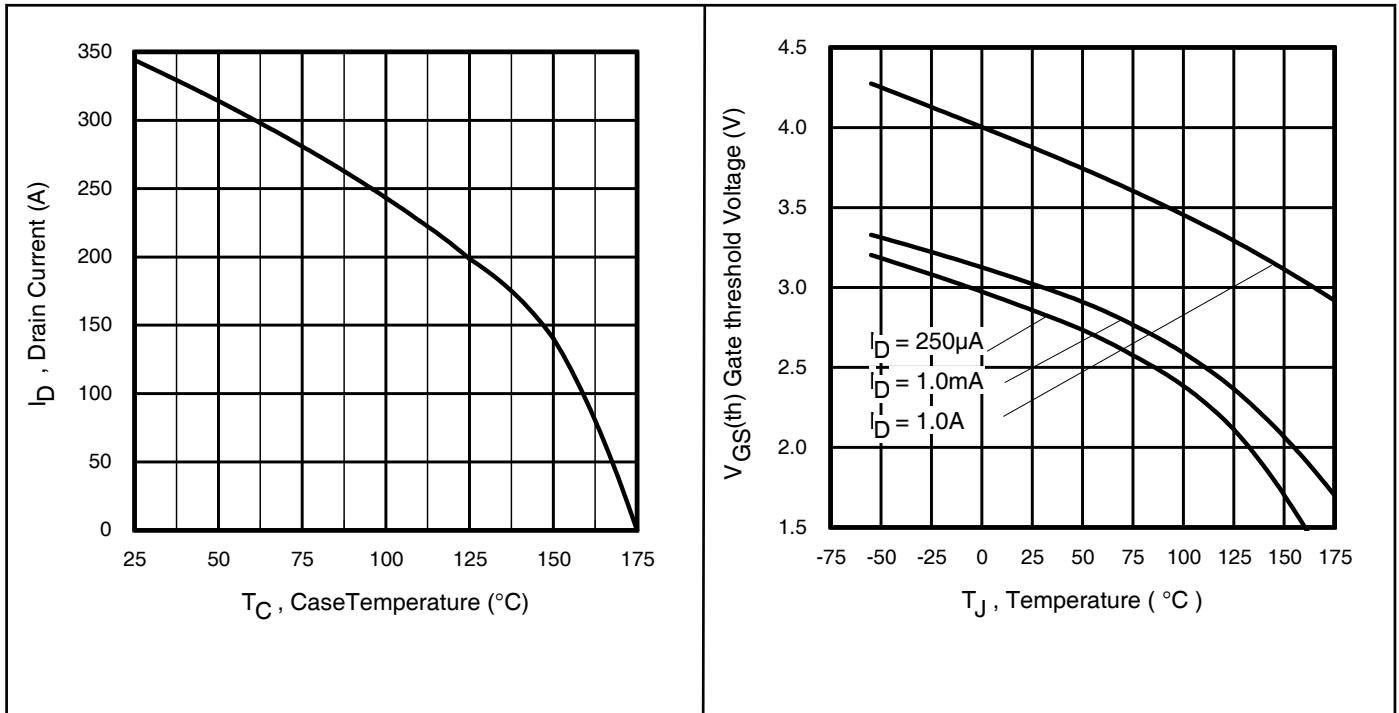

Figure 11 Maximum Drain Current vs. Case Temperature

Figure 12 Typical Threshold Voltage vs. Junction Temperature

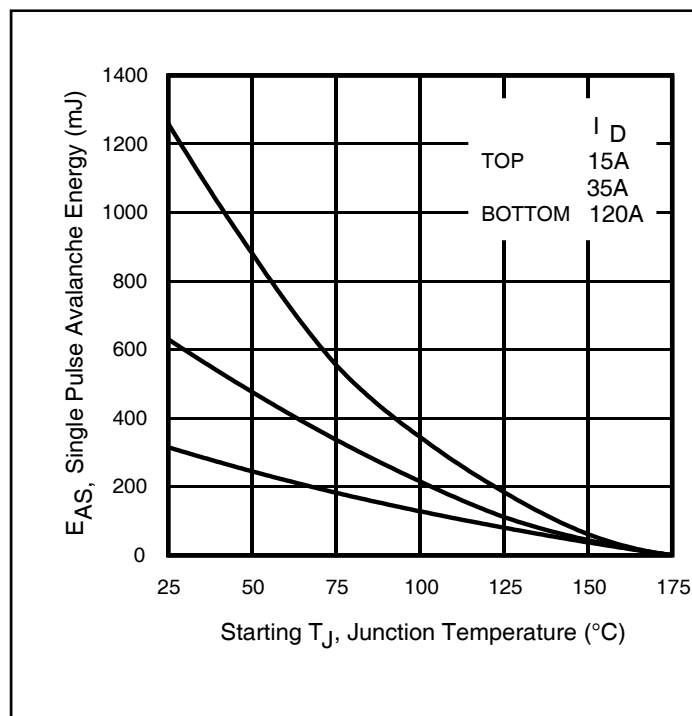

Figure 13 Maximum Avalanche Energy vs. Temperature



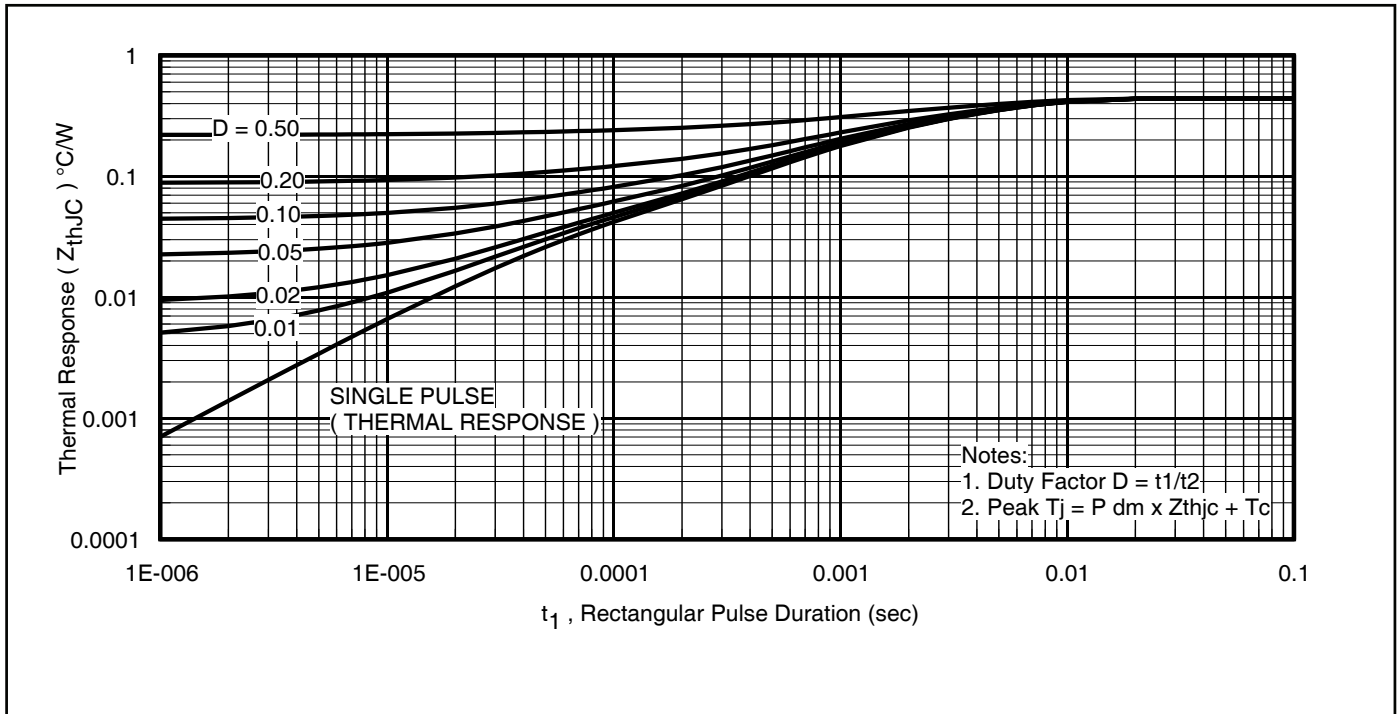

Figure 14 Maximum Effective Transient Thermal Impedance, Junction-to-Case

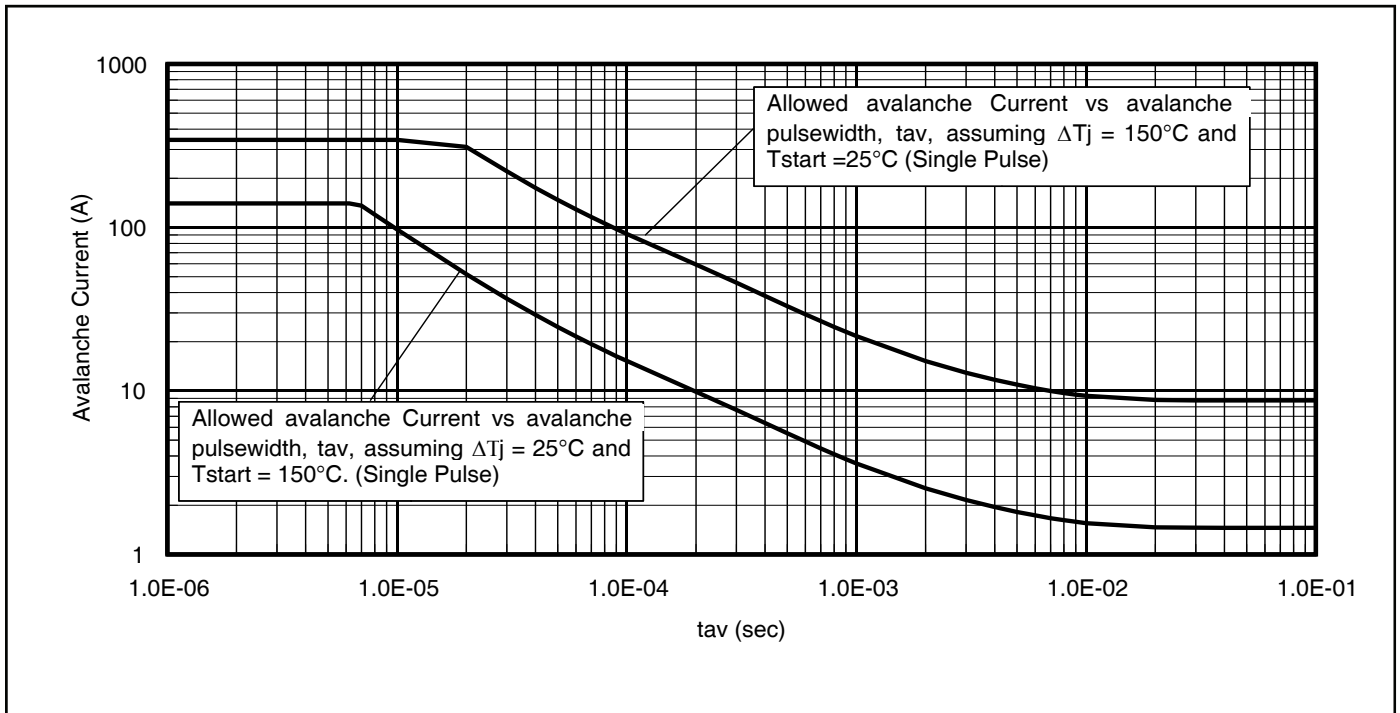
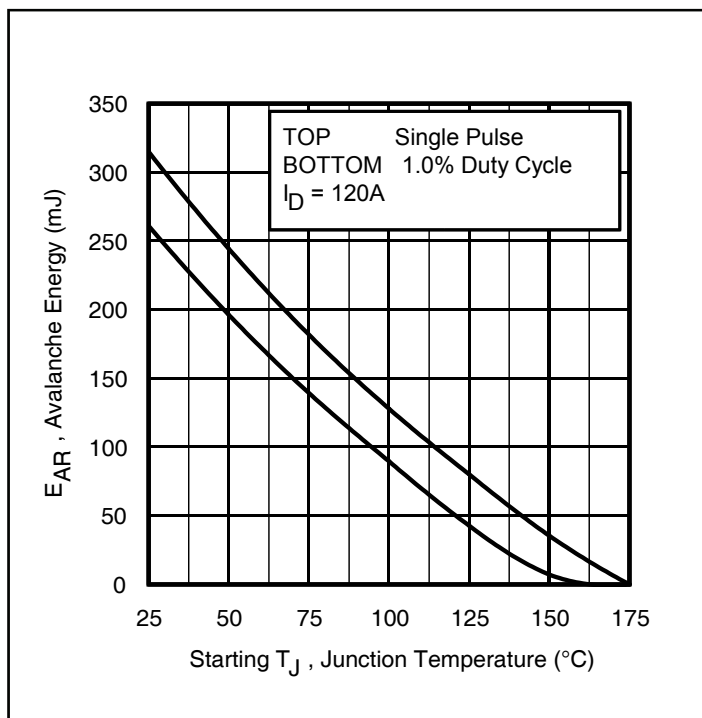

Figure 15 Typical Avalanche Current vs. Pulse Width



**Notes on Repetitive Avalanche Curves , Figures 15, 16:  
(For further info, see AN-1005 at [www.infineon.com](http://www.infineon.com))**

1. Avalanche failures assumption:  
Purely a thermal phenomenon and failure occurs at a temperature far in excess of  $T_{jmax}$ . This is validated for every part type.
2. Safe operation in Avalanche is allowed as long as  $T_{jmax}$  is not exceeded.
3. Equation below based on circuit and waveforms shown in Figures 19a, 19b.
4.  $P_{D(ave)}$  = Average power dissipation per single avalanche pulse.
5.  $BV$  = Rated breakdown voltage (1.3 factor accounts for voltage increase during avalanche).
6.  $I_{av}$  = Allowable avalanche current.
7.  $DT$  = Allowable rise in junction temperature, not to exceed  $T_{jmax}$  (assumed as 25°C in Figure 14, 15).  
 $t_{av}$  = Average time in avalanche.  
 $D$  = Duty cycle in avalanche =  $t_{av} \cdot f$   
 $Z_{thJC}(D, t_{av})$  = Transient thermal resistance, see Figures 14)  
 $P_{D(ave)} = 1/2 (1.3 \cdot BV \cdot I_{av}) = \Delta T / Z_{thJC}$   
 $I_{av} = 2\Delta T / [1.3 \cdot BV \cdot Z_{th}]$   
 $E_{AS(AR)} = P_{D(ave)} \cdot t_{av}$

**Figure 16 Maximum Avalanche Energy vs. Temperature**

**Notes:**

- ① Used double sided cooling , mounting pad with large heatsink
- ② Mounted on minimum footprint full size board with metalized back and with small clip heatsink.
- ③ TC measured with thermocouple mounted to top (Drain) of part.

① Surface mounted on 1 in. square Cu board (still air).

② Mounted to a PCB with small clip heatsink (still air).

③ Mounted on minimum footprint full size board with metalized back and with small clip heatsink (still air).

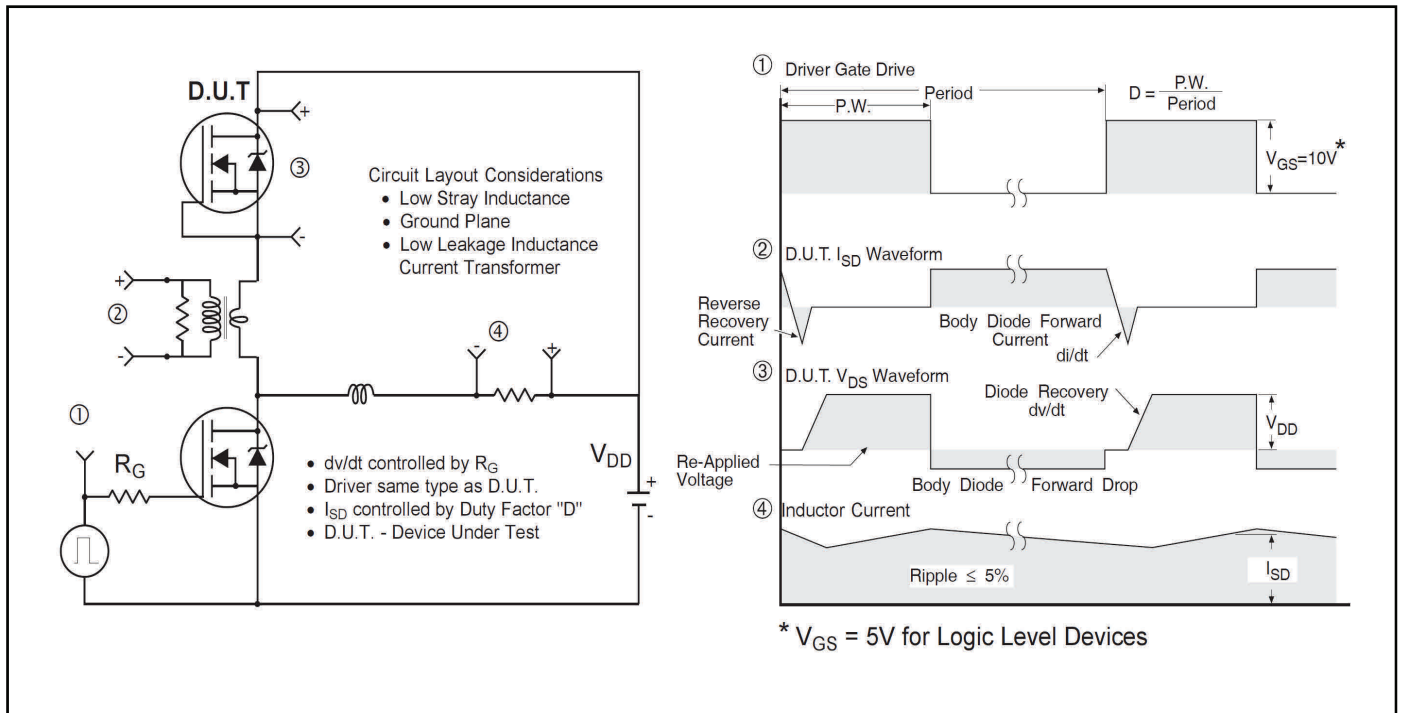

Figure 17 Peak Diode Recovery dv/dt Test Circuit for N-Channel HEXFET™ Power MOSFETs

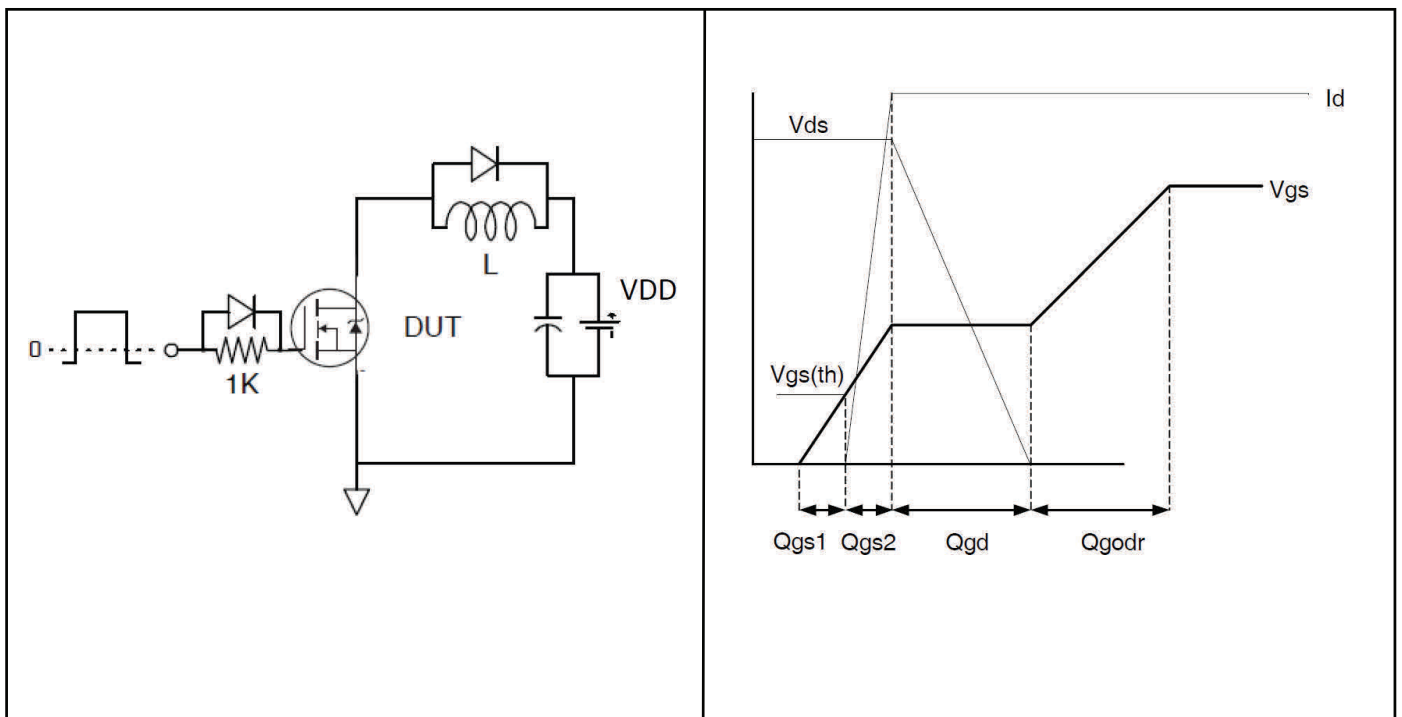

Figure 18a Gate Charge Test Circuit

Figure 18b Gate Charge Waveform

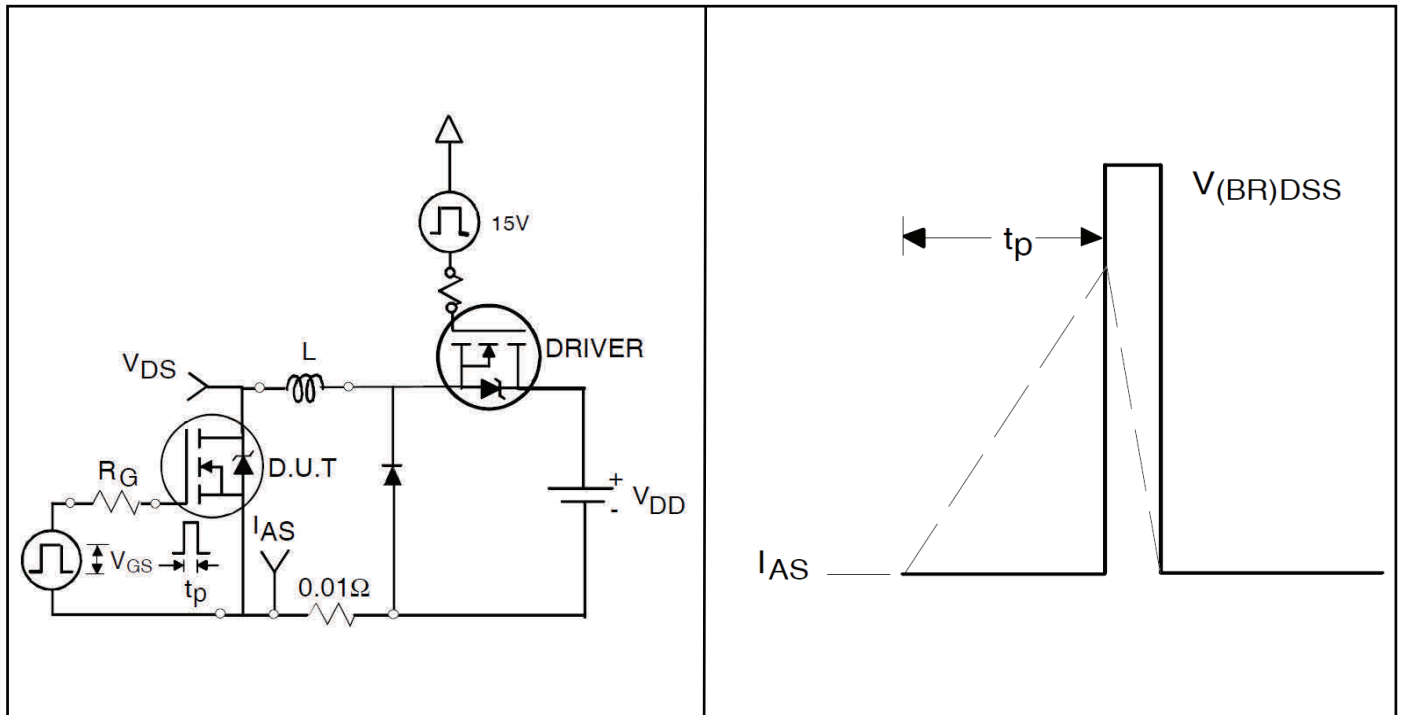

Figure 19a Unclamped Inductive Test Circuit

Figure 19b Unclamped Inductive Waveforms

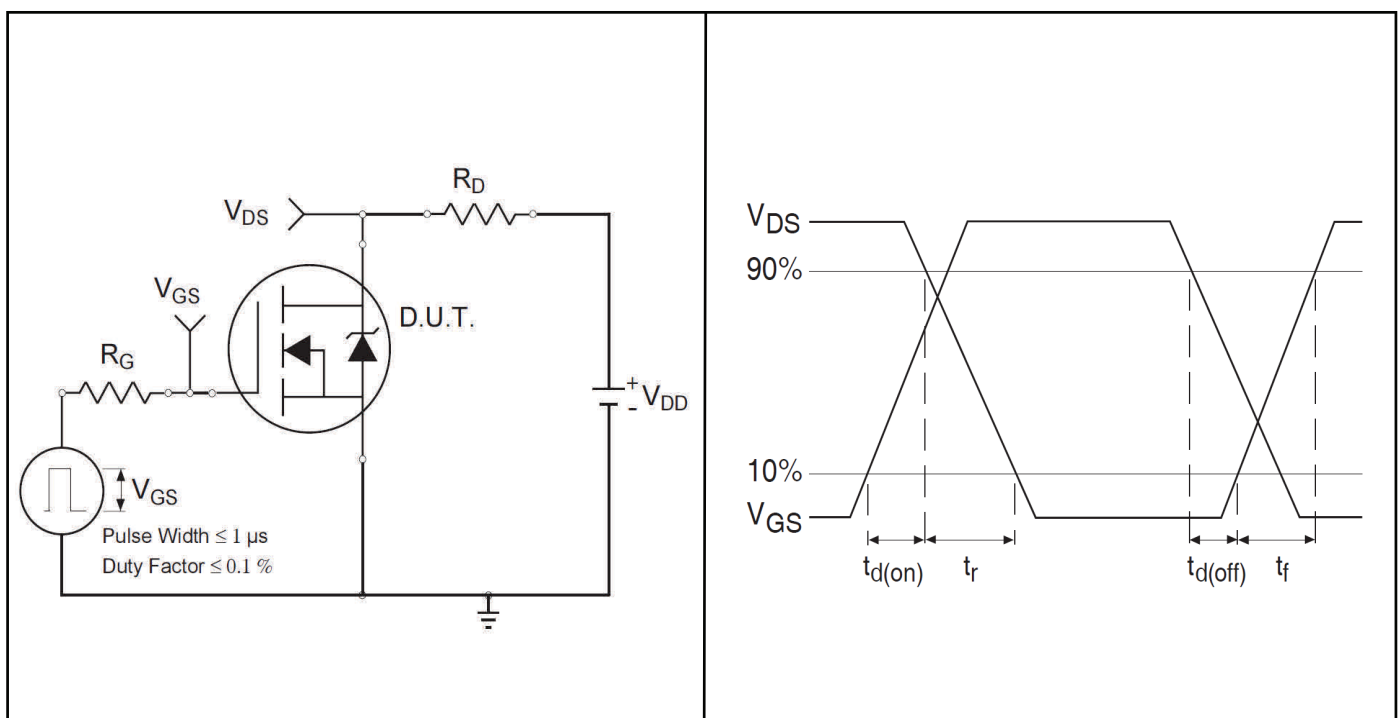

Figure 20a Switching Time Test Circuit

Figure 20b Switching Time Waveforms

## 5 Package Information

### DirectFET™ Board Footprint, L8 Outline (Large Size Can, 8-Source Pads)

Please see DirectFET™ application note [AN-1035](#) for all details regarding the assembly of DirectFET™. This includes all recommendations for stencil and substrate designs.

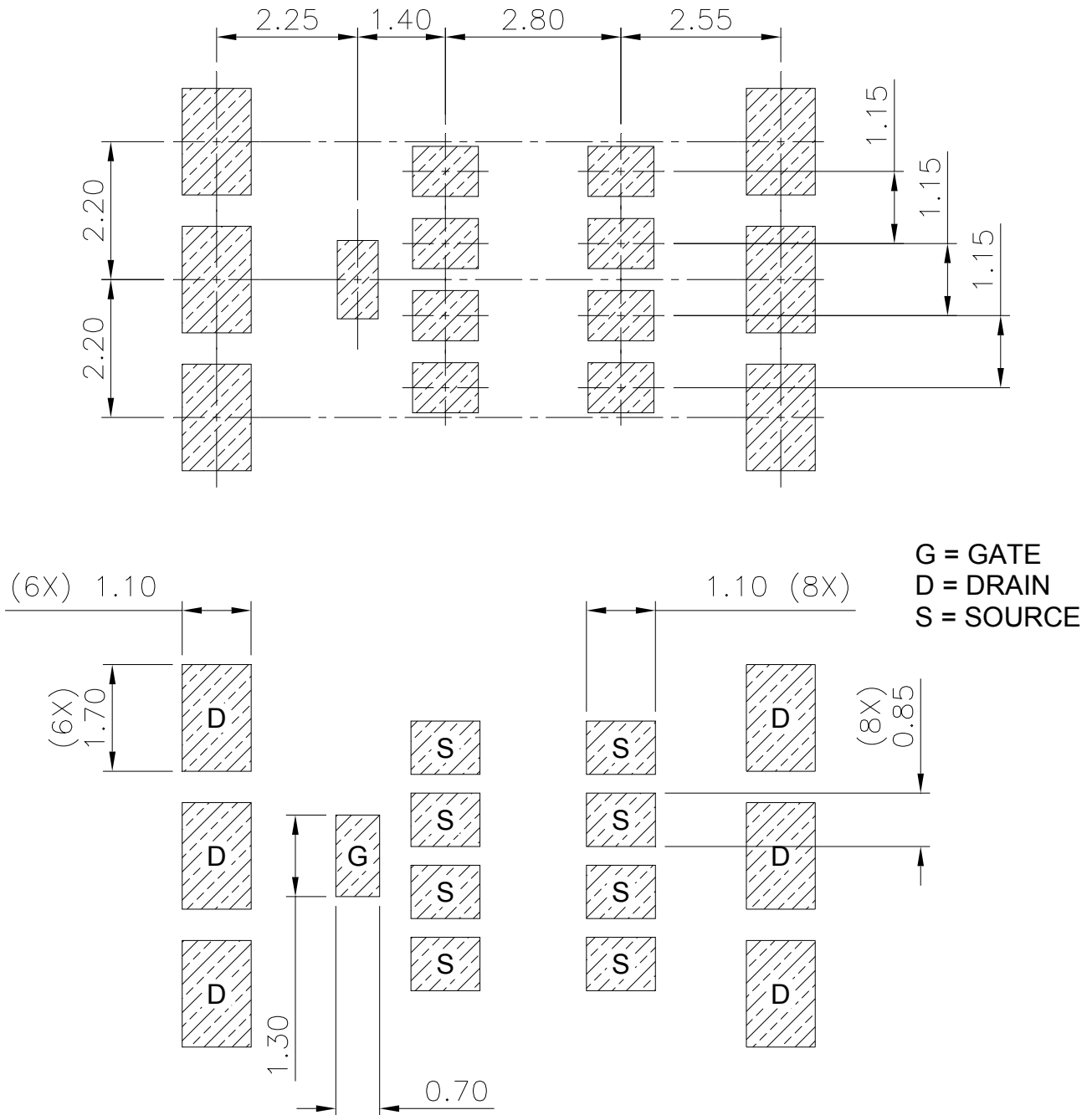

IRF7749L1TRPbF

Package Information

DirectFET™ Outline Dimension, L8 Outline  
(Large Size Can, 8-Source Pads)

Please see DirectFET™ application note [AN-1035](#) for all details regarding the assembly of DirectFET™. This includes all recommendations for stencil and substrate designs.

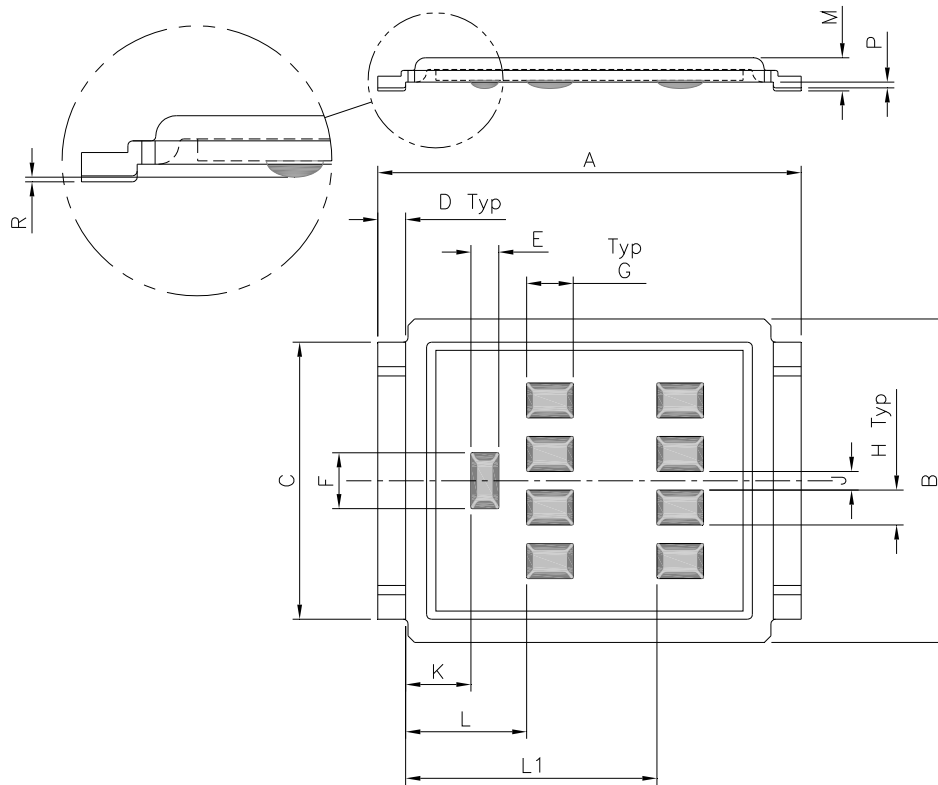

CODE	METRIC		IMPERIAL	
	MIN	MAX	MIN	MAX
A	9.05	9.15	0.356	0.360
B	6.85	7.10	0.270	0.280
C	5.90	6.00	0.232	0.236
D	0.55	0.65	0.022	0.026
E	0.58	0.62	0.023	0.024
F	1.18	1.22	0.046	0.048
G	0.98	1.02	0.039	0.040
H	0.73	0.77	0.029	0.030
J	0.38	0.42	0.015	0.017
K	1.35	1.45	0.053	0.057
L	2.55	2.65	0.100	0.104
L1	5.35	5.45	0.211	0.215
M	0.68	0.74	0.027	0.029
P	0.09	0.17	0.003	0.007
R	0.02	0.08	0.001	0.003

DirectFET™ Part Marking

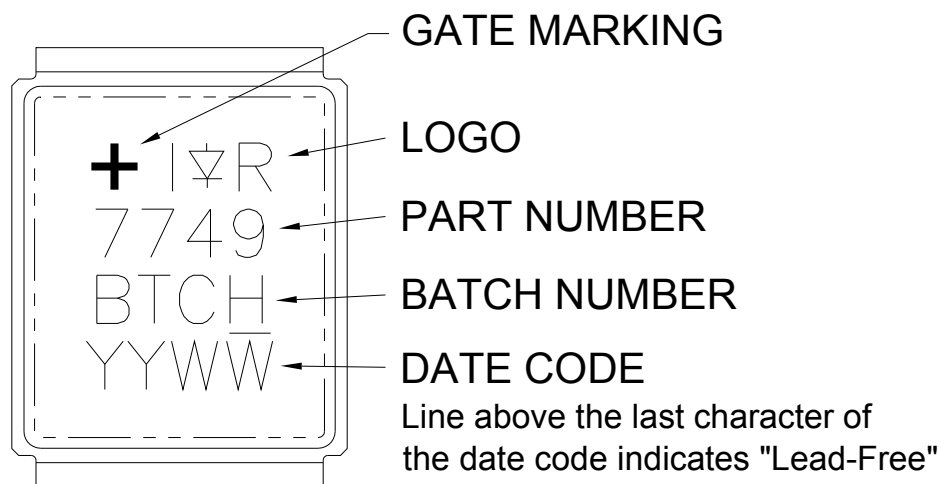

Tape & Reel Information

DirectFET™ Tape & Reel Dimension (Showing component orientation).

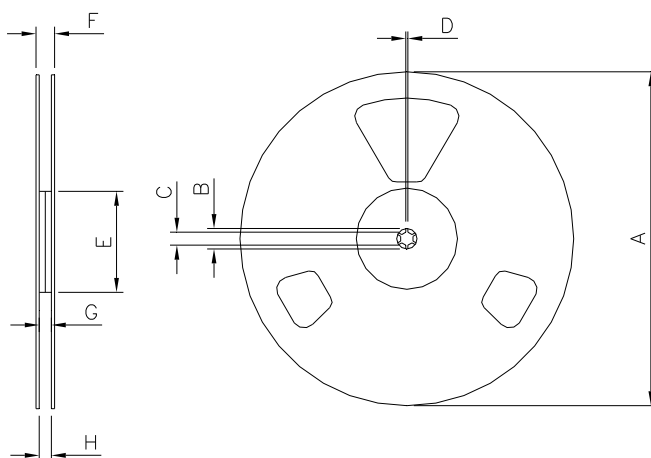

NOTE: Controlling dimensions in mm  
Std reel quantity is 4000 parts. (ordered as IRF7749L1TRPbF).

REEL DIMENSIONS				
STANDARD OPTION (QTY 4000)				
	METRIC		IMPERIAL	
CODE	MIN	MAX	MIN	MAX
A	330.00	N.C	12.992	N.C
B	20.20	N.C	0.795	N.C
C	12.80	13.20	0.504	0.520
D	1.50	N.C	0.059	N.C
E	99.00	100.00	3.900	3.940
F	N.C	22.40	N.C	0.880
G	16.40	18.40	0.650	0.720
H	15.90	19.40	0.630	0.760

LOADED TAPE FEED DIRECTION

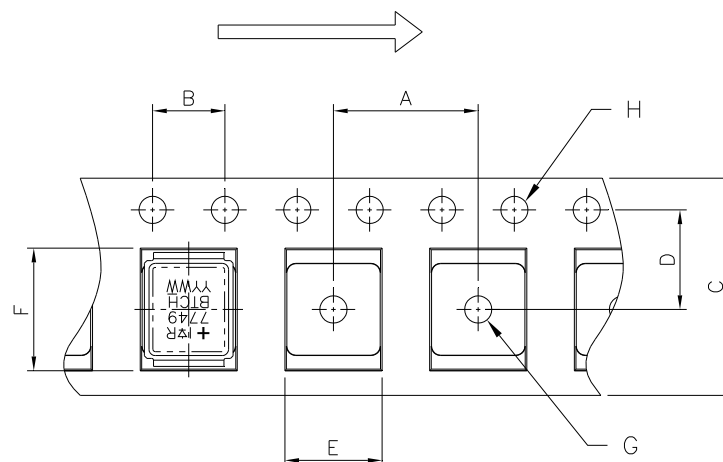

NOTE: CONTROLLING DIMENSIONS IN MM

DIMENSIONS				
	METRIC		IMPERIAL	
CODE	MIN	MAX	MIN	MAX
A	11.90	12.10	4.69	0.476
B	3.90	4.10	0.154	0.161
C	15.90	16.30	0.623	0.642
D	7.40	7.60	0.291	0.299
E	7.20	7.40	0.283	0.291
F	9.90	10.10	0.390	0.398
G	1.50	N.C	0.059	N.C
H	1.50	1.60	0.059	0.063

## 6 Qualification Information

### Qualification Information

<b>Qualification Level</b>	Industrial (per JEDEC JESD47F) †	
<b>Moisture Sensitivity Level</b>	DirectFET™ Large Can	MSL1 (per JEDEC J-STD-020D)†
<b>RoHS Compliant</b>	Yes	

† Applicable version of JEDEC standard at the time of product release.



## Revision History

### Major changes since the last revision

Page or Reference	Revision	Date	Description of changes
All pages	2.0	2013-01-07	• First release Final data sheet.
All pages	2.1	2013-02-13	• TR1 option removed and Tape & Reel Info updated accordingly. • Hyperlinks added throw-out the document
All pages	2.2	2019-02-20	• Update to R-Theta.

### Trademarks of Infineon Technologies AG

μHVIC™, μIPM™, μPFC™, AU-ConvertIR™, AURIX™, C166™, CanPAK™, CIPOST™, CIPURSE™, CoolDP™, CoolGaN™, COOLiR™, CoolMOS™, CoolSET™, CoolSiC™, DAVE™, DI-POL™, DirectFET™, DrBlade™, EasyPIM™, EconoBRIDGE™, EconoDUAL™, EconoPACK™, EconoPIM™, EiceDRIVER™, eupec™, FCOS™, GaNpowIR™, HEXFET™, HITFET™, HybridPACK™, iMOTION™, IRAM™, ISOFACE™, IsoPACK™, LEDrivIR™, LITIX™, MIPAQ™, ModSTACK™, my-d™, NovalithIC™, OPTIGA™, OptiMOS™, ORIGA™, PowIRaudio™, PowIRstage™, PrimePACK™, PrimeSTACK™, PROFET™, PRO-SIL™, RASIC™, REAL3™, SmartLEWIS™, SOLID FLASH™, SPOC™, StrongIRFET™, SupIRBuck™, TEMPFET™, TRENCHSTOP™, TriCore™, UHVIC™, XHP™, XMC™

Trademarks updated November 2015

### Other Trademarks

All referenced product or service names and trademarks are the property of their respective owners.

### IMPORTANT NOTICE

The information given in this document shall in no event be regarded as a guarantee of conditions or characteristics ("Beschaffenheitsgarantie").

With respect to any examples, hints or any typical values stated herein and/or any information regarding the application of the product, Infineon Technologies hereby disclaims any and all warranties and liabilities of any kind, including without limitation warranties of non-infringement of intellectual property rights of any third party.

In addition, any information given in this document is subject to customer's compliance with its obligations stated in this document and any applicable legal requirements, norms and standards concerning customer's products and any use of the product of Infineon Technologies in customer's applications.

The data contained in this document is exclusively intended for technically trained staff. It is the responsibility of customer's technical departments to evaluate the suitability of the product for the intended application and the completeness of the product information given in this document with

For further information on the product, technology, delivery terms and conditions and prices please contact your nearest Infineon Technologies office ([www.infineon.com](http://www.infineon.com)).

### WARNINGS

Due to technical requirements products may contain dangerous substances. For information on the types in question please contact your nearest Infineon Technologies office.

Except as otherwise explicitly approved by Infineon Technologies in a written document signed by authorized representatives of Infineon Technologies, Infineon Technologies' products may not be used in any applications where a failure of the product or any consequences of the use thereof can reasonably be expected to result in personal injury.

**Edition 2015-05-06**

**Published by  
Infineon Technologies AG  
81726 Munich, Germany**

**© 2016 Infineon Technologies AG.  
All Rights Reserved.**

**Do you have a question about this document?**

**Email: [erratum@infineon.com](mailto:erratum@infineon.com)**

**Document reference**

# Mouser Electronics

Authorized Distributor

Click to View Pricing, Inventory, Delivery & Lifecycle Information:

[Infineon:](#)

[IRF7749L1TRPBF](#)