

## MOSFET

Metal Oxide Semiconductor Field Effect Transistor

## CoolMOS™ P6

600V CoolMOS™ P6 Power Transistor  
IPx60R230P6

## Data Sheet

Rev. 2.2  
Final

## 1 Description

CoolMOS™ is a revolutionary technology for high voltage power MOSFETs, designed according to the superjunction (SJ) principle and pioneered by Infineon Technologies. CoolMOS™ P6 series combines the experience of the leading SJ MOSFET supplier with high class innovation. The offered devices provide all benefits of a fast switching SJ MOSFET while not sacrificing ease of use. Extremely low switching and conduction losses make switching applications even more efficient, more compact, lighter and cooler.

## Features

- Increased MOSFET dv/dt ruggedness
- Extremely low losses due to very low FOM  $R_{DS(on)} \cdot Q_g$  and  $E_{oss}$
- Very high commutation ruggedness
- Easy to use/drive
- Pb-free plating, Halogen free mold compound
- Qualified for industrial grade applications according to JEDEC (J-STD20 and JESD22)

## Applications

PFC stages, hard switching PWM stages and resonant switching stages for e.g. PC Silverbox, Adapter, LCD & PDP TV, Lighting, Server, Telecom and UPS.

*Please note: For MOSFET paralleling the use of ferrite beads on the gate or separate totem poles is generally recommended.*

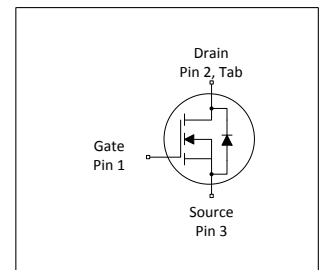
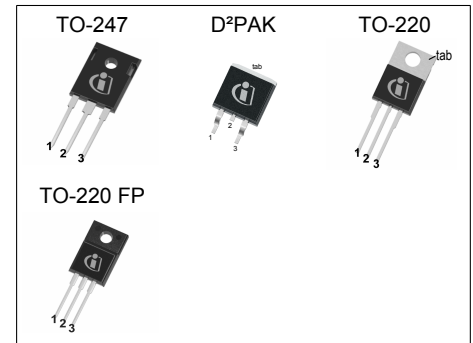

**Table 1 Key Performance Parameters**

| Parameter            | Value | Unit |
|----------------------|-------|------|
| $V_{DS} @ T_{j,max}$ | 650   | V    |
| $R_{DS(on),max}$     | 230   | mΩ   |
| $Q_{g,typ}$          | 31    | nC   |
| $I_{D,pulse}$        | 48    | A    |
| $E_{oss@400V}$       | 4.2   | μJ   |
| Body diode di/dt     | 500   | A/μs |

| Type / Ordering Code | Package           | Marking | Related Links  |
|----------------------|-------------------|---------|----------------|
| IPW60R230P6          | PG-TO 247         | 6R230P6 | see Appendix A |
| IPB60R230P6          | PG-TO 263         |         |                |
| IPP60R230P6          | PG-TO 220         |         |                |
| IPA60R230P6          | PG-TO 220 FullPAK |         |                |



## Table of Contents

|   |    |
|---|----|
| Description .....                         | 2  |
| Maximum ratings .....                     | 4  |
| Thermal characteristics .....             | 5  |
| Electrical characteristics .....          | 6  |
| Electrical characteristics diagrams ..... | 8  |
| Test Circuits .....                       | 13 |
| Package Outlines .....                    | 14 |
| Appendix A .....                          | 18 |
| Revision History .....                    | 19 |
| Disclaimer .....                          | 19 |

## 2 Maximum ratings

at  $T_j = 25^\circ\text{C}$ , unless otherwise specified

**Table 2 Maximum ratings**

| Parameter   | Symbol        | Values |      |              | Unit             | Note / Test Condition  |
|---|---------------|--------|------|--------------|------------------|--|
|   |               | Min.   | Typ. | Max.         |                  |  |
| Continuous drain current <sup>1)</sup>                    | $I_D$         | -      | -    | 16.8<br>10.7 | A                | $T_C=25^\circ\text{C}$<br>$T_C=100^\circ\text{C}$                                      |
| Pulsed drain current <sup>2)</sup>                        | $I_{D,pulse}$ | -      | -    | 48           | A                | $T_C=25^\circ\text{C}$   |
| Avalanche energy, single pulse                            | $E_{AS}$      | -      | -    | 352          | mJ               | $I_D=2.9\text{A}$ ; $V_{DD}=50\text{V}$ ; see table 12                                 |
| Avalanche energy, repetitive                              | $E_{AR}$      | -      | -    | 0.53         | mJ               | $I_D=2.9\text{A}$ ; $V_{DD}=50\text{V}$ ; see table 12                                 |
| Avalanche current, repetitive                             | $I_{AR}$      | -      | -    | 2.9          | A                | -  |
| MOSFET dv/dt ruggedness                                   | dv/dt         | -      | -    | 100          | V/ns             | $V_{DS}=0\dots400\text{V}$   |
| Gate source voltage (static)                              | $V_{GS}$      | -20    | -    | 20           | V                | static;  |
| Gate source voltage (dynamic)                             | $V_{GS}$      | -30    | -    | 30           | V                | AC ( $f>1\text{ Hz}$ )   |
| Power dissipation (Non FullPAK)<br>TO-220, TO-263, TO-247 | $P_{tot}$     | -      | -    | 126          | W                | $T_C=25^\circ\text{C}$   |
| Power dissipation (FullPAK)<br>TO-220FP                   | $P_{tot}$     | -      | -    | 33           | W                | $T_C=25^\circ\text{C}$   |
| Storage temperature                                       | $T_{stg}$     | -55    | -    | 150          | $^\circ\text{C}$ | -  |
| Operating junction temperature                            | $T_j$         | -55    | -    | 150          | $^\circ\text{C}$ | -  |
| Mounting torque (Non FullPAK)<br>TO-220, TO-247           | -             | -      | -    | 60           | Ncm              | M3 and M3.5 screws   |
| Mounting torque (FullPAK)<br>TO-220FP                     | -             | -      | -    | 50           | Ncm              | M2.5 screws  |
| Continuous diode forward current                          | $I_S$         | -      | -    | 14.5         | A                | $T_C=25^\circ\text{C}$   |
| Diode pulse current <sup>2)</sup>                         | $I_{S,pulse}$ | -      | -    | 48           | A                | $T_C=25^\circ\text{C}$   |
| Reverse diode dv/dt <sup>3)</sup>                         | dv/dt         | -      | -    | 15           | V/ns             | $V_{DS}=0\dots400\text{V}$ , $I_{SD}\leq I_S$ , $T_j=25^\circ\text{C}$<br>see table 10 |
| Maximum diode commutation speed                           | di/dt         | -      | -    | 500          | A/ $\mu\text{s}$ | $V_{DS}=0\dots400\text{V}$ , $I_{SD}\leq I_S$ , $T_j=25^\circ\text{C}$<br>see table 10 |
| Insulation withstand voltage for<br>TO-220FP              | $V_{ISO}$     | -      | -    | 2500         | V                | $V_{rms}$ , $T_C=25^\circ\text{C}$ , $t=1\text{min}$                                   |

<sup>1)</sup> Limited by  $T_{j,max}$ . Maximum duty cycle  $D=0.75$

<sup>2)</sup> Pulse width  $t_p$  limited by  $T_{j,max}$

<sup>3)</sup> Identical low side and high side switch with identical  $R_G$

### 3 Thermal characteristics

**Table 3 Thermal characteristics (Non FullPAK) TO-220, TO-247**

| Parameter  | Symbol     | Values |      |      | Unit | Note / Test Condition               |
|--|------------|--------|------|------|------|-------------------------------------|
|  |            | Min.   | Typ. | Max. |      |                                     |
| Thermal resistance, junction - case                        | $R_{thJC}$ | -      | -    | 0.99 | °C/W | -                                   |
| Thermal resistance, junction - ambient                     | $R_{thJA}$ | -      | -    | 62   | °C/W | leaded                              |
| Soldering temperature, wavesoldering only allowed at leads | $T_{sold}$ | -      | -    | 260  | °C   | 1.6mm (0.063 in.) from case for 10s |

**Table 4 Thermal characteristics (FullPAK) TO-220FP**

| Parameter  | Symbol     | Values |      |      | Unit | Note / Test Condition               |
|--|------------|--------|------|------|------|-------------------------------------|
|  |            | Min.   | Typ. | Max. |      |                                     |
| Thermal resistance, junction - case                        | $R_{thJC}$ | -      | -    | 3.8  | °C/W | -                                   |
| Thermal resistance, junction - ambient                     | $R_{thJA}$ | -      | -    | 80   | °C/W | leaded                              |
| Soldering temperature, wavesoldering only allowed at leads | $T_{sold}$ | -      | -    | 260  | °C   | 1.6mm (0.063 in.) from case for 10s |

**Table 5 Thermal characteristics TO-263**

| Parameter  | Symbol     | Values |      |      | Unit | Note / Test Condition   |
|--|------------|--------|------|------|------|---|
|  |            | Min.   | Typ. | Max. |      |   |
| Thermal resistance, junction - case                    | $R_{thJC}$ | -      | -    | 0.99 | °C/W | -   |
| Thermal resistance, junction - ambient                 | $R_{thJA}$ | -      | -    | 62   | °C/W | device on PCB, minimal footprint  |
| Thermal resistance, junction - ambient for SMD version | $R_{thJA}$ | -      | 35   | 45   | °C/W | Device on 40mm*40mm*1.5mm epoxy PCB FR4 with 6cm <sup>2</sup> (one layer, 70µm thickness) copper area for drain connection and cooling. PCB is vertical without air stream cooling. |
| Soldering temperature, wave & reflow soldering allowed | $T_{sold}$ | -      | -    | 260  | °C   | reflow MSL1   |

## 4 Electrical characteristics

at  $T_j=25^\circ\text{C}$ , unless otherwise specified

**Table 6 Static characteristics**

| Parameter                        | Symbol        | Values |                |            | Unit          | Note / Test Condition   |
|----------------------------------|---------------|--------|----------------|------------|---------------|---|
|                                  |               | Min.   | Typ.           | Max.       |               |   |
| Drain-source breakdown voltage   | $V_{(BR)DSS}$ | 600    | -              | -          | V             | $V_{GS}=0\text{V}$ , $I_D=1\text{mA}$   |
| Gate threshold voltage           | $V_{(GS)th}$  | 3.5    | 4.0            | 4.5        | V             | $V_{DS}=V_{GS}$ , $I_D=0.53\text{mA}$   |
| Zero gate voltage drain current  | $I_{DSS}$     | -      | -              | 1          | $\mu\text{A}$ | $V_{DS}=600$ , $V_{GS}=0\text{V}$ , $T_j=25^\circ\text{C}$<br>$V_{DS}=600$ , $V_{GS}=0\text{V}$ , $T_j=150^\circ\text{C}$             |
| Gate-source leakage current      | $I_{GSS}$     | -      | -              | 100        | nA            | $V_{GS}=20\text{V}$ , $V_{DS}=0\text{V}$  |
| Drain-source on-state resistance | $R_{DS(on)}$  | -      | 0.207<br>0.538 | 0.230<br>- | $\Omega$      | $V_{GS}=10\text{V}$ , $I_D=6.4\text{A}$ , $T_j=25^\circ\text{C}$<br>$V_{GS}=10\text{V}$ , $I_D=6.4\text{A}$ , $T_j=150^\circ\text{C}$ |
| Gate resistance                  | $R_G$         | -      | 4.4            | -          | $\Omega$      | $f=1\text{MHz}$ , open drain  |

**Table 7 Dynamic characteristics**

| Parameter  | Symbol       | Values |      |      | Unit | Note / Test Condition  |
|--|--------------|--------|------|------|------|--|
|  |              | Min.   | Typ. | Max. |      |  |
| Input capacitance  | $C_{iss}$    | -      | 1450 | -    | pF   | $V_{GS}=0\text{V}$ , $V_{DS}=100\text{V}$ , $f=1\text{MHz}$                                      |
| Output capacitance   | $C_{oss}$    | -      | 64   | -    | pF   | $V_{GS}=0\text{V}$ , $V_{DS}=100\text{V}$ , $f=1\text{MHz}$                                      |
| Effective output capacitance, energy related <sup>1)</sup> | $C_{o(er)}$  | -      | 52   | -    | pF   | $V_{GS}=0\text{V}$ , $V_{DS}=0\dots400\text{V}$  |
| Effective output capacitance, time related <sup>2)</sup>   | $C_{o(tr)}$  | -      | 220  | -    | pF   | $I_D=\text{constant}$ , $V_{GS}=0\text{V}$ , $V_{DS}=0\dots400\text{V}$                          |
| Turn-on delay time   | $t_{d(on)}$  | -      | 12   | -    | ns   | $V_{DD}=400\text{V}$ , $V_{GS}=13\text{V}$ , $I_D=8\text{A}$ ,<br>$R_G=3.4\Omega$ ; see table 11 |
| Rise time  | $t_r$        | -      | 7    | -    | ns   | $V_{DD}=400\text{V}$ , $V_{GS}=13\text{V}$ , $I_D=8\text{A}$ ,<br>$R_G=3.4\Omega$ ; see table 11 |
| Turn-off delay time  | $t_{d(off)}$ | -      | 38   | -    | ns   | $V_{DD}=400\text{V}$ , $V_{GS}=13\text{V}$ , $I_D=8\text{A}$ ,<br>$R_G=3.4\Omega$ ; see table 11 |
| Fall time  | $t_f$        | -      | 6    | -    | ns   | $V_{DD}=400\text{V}$ , $V_{GS}=13\text{V}$ , $I_D=8\text{A}$ ,<br>$R_G=3.4\Omega$ ; see table 11 |

**Table 8 Gate charge characteristics**

| Parameter             | Symbol        | Values |      |      | Unit | Note / Test Condition   |
|-----------------------|---------------|--------|------|------|------|---|
|                       |               | Min.   | Typ. | Max. |      |   |
| Gate to source charge | $Q_{gs}$      | -      | 9    | -    | nC   | $V_{DD}=400\text{V}$ , $I_D=8\text{A}$ , $V_{GS}=0$ to $10\text{V}$ |
| Gate to drain charge  | $Q_{gd}$      | -      | 11   | -    | nC   | $V_{DD}=400\text{V}$ , $I_D=8\text{A}$ , $V_{GS}=0$ to $10\text{V}$ |
| Gate charge total     | $Q_g$         | -      | 31   | -    | nC   | $V_{DD}=400\text{V}$ , $I_D=8\text{A}$ , $V_{GS}=0$ to $10\text{V}$ |
| Gate plateau voltage  | $V_{plateau}$ | -      | 6.1  | -    | V    | $V_{DD}=400\text{V}$ , $I_D=8\text{A}$ , $V_{GS}=0$ to $10\text{V}$ |

<sup>1)</sup>  $C_{o(er)}$  is a fixed capacitance that gives the same stored energy as  $C_{oss}$  while  $V_{DS}$  is rising from 0 to 400V

<sup>2)</sup>  $C_{o(tr)}$  is a fixed capacitance that gives the same charging time as  $C_{oss}$  while  $V_{DS}$  is rising from 0 to 400V

**Table 9 Reverse diode characteristics**

| Parameter                     | Symbol    | Values |      |      | Unit    | Note / Test Condition                                    |
|-------------------------------|-----------|--------|------|------|---------|--|
|                               |           | Min.   | Typ. | Max. |         |  |
| Diode forward voltage         | $V_{SD}$  | -      | 0.9  | -    | V       | $V_{GS}=0V, I_F=8A, T_j=25^\circ C$                      |
| Reverse recovery time         | $t_{rr}$  | -      | 282  | -    | ns      | $V_R=400V, I_F=8A, di_F/dt=100A/\mu s$ ;<br>see table 10 |
| Reverse recovery charge       | $Q_{rr}$  | -      | 3.4  | -    | $\mu C$ | $V_R=400V, I_F=8A, di_F/dt=100A/\mu s$ ;<br>see table 10 |
| Peak reverse recovery current | $I_{rrm}$ | -      | 24   | -    | A       | $V_R=400V, I_F=8A, di_F/dt=100A/\mu s$ ;<br>see table 10 |

## 5 Electrical characteristics diagrams

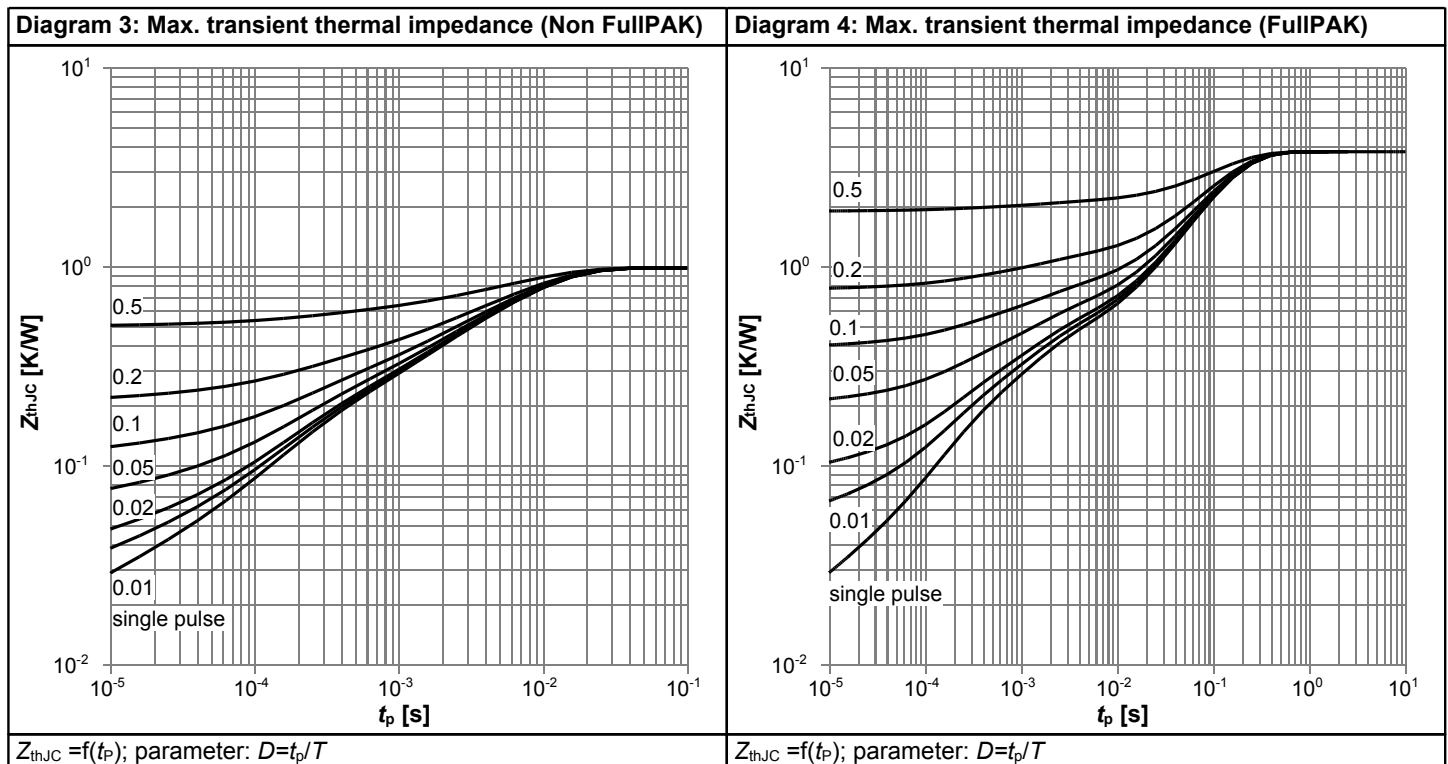
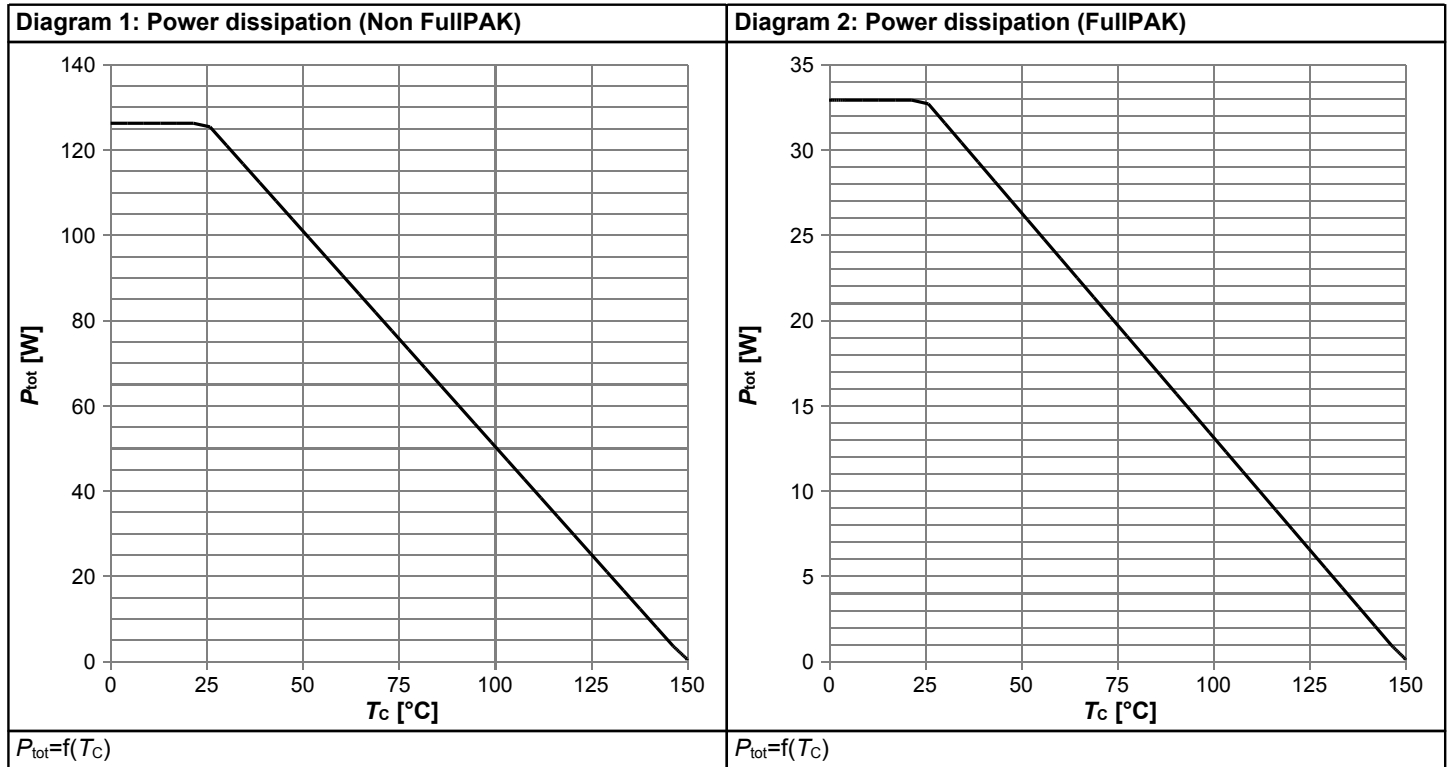
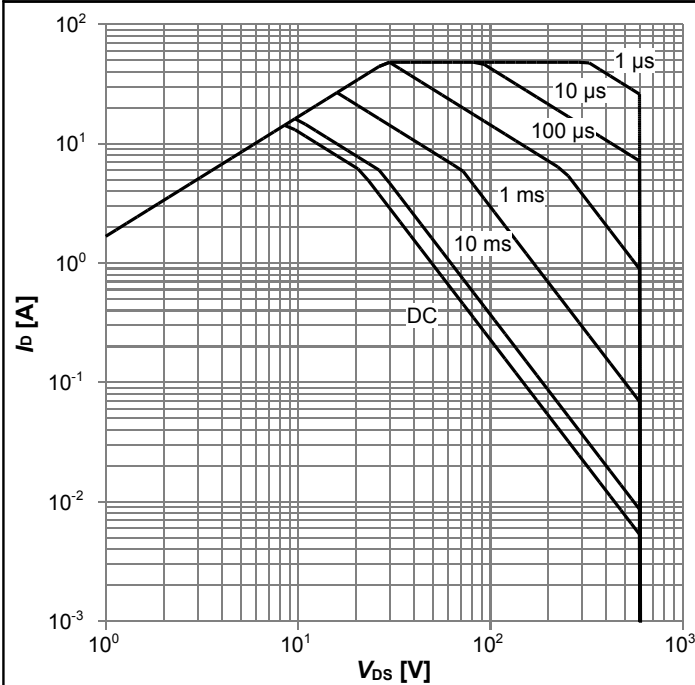

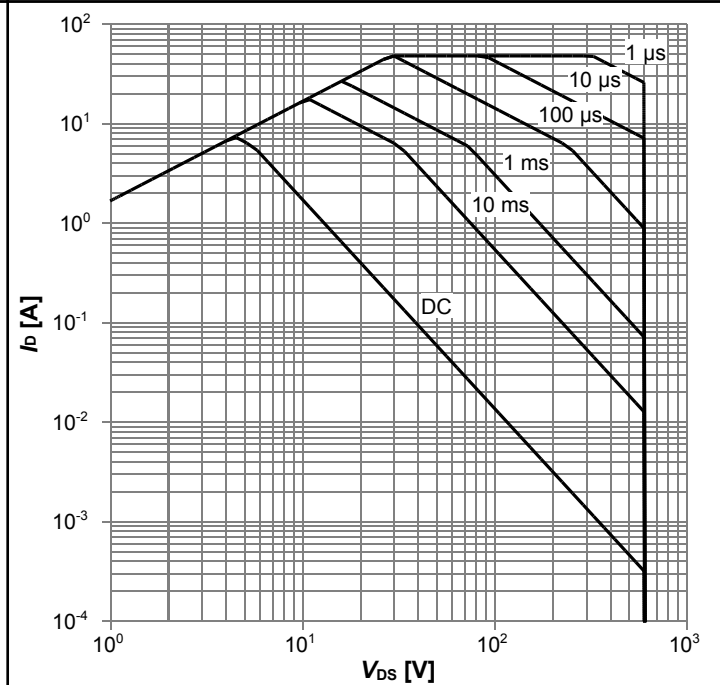

Diagram 5: Safe operating area (Non FullPAK)



$I_D=f(V_{DS}); T_C=25\text{ °C}; D=0$ ; parameter:  $t_p$

Diagram 6: Safe operating area (FullPAK)



$I_D=f(V_{DS}); T_C=25\text{ °C}; D=0$ ; parameter:  $t_p$

Diagram 7: Safe operating area (Non FullPAK)

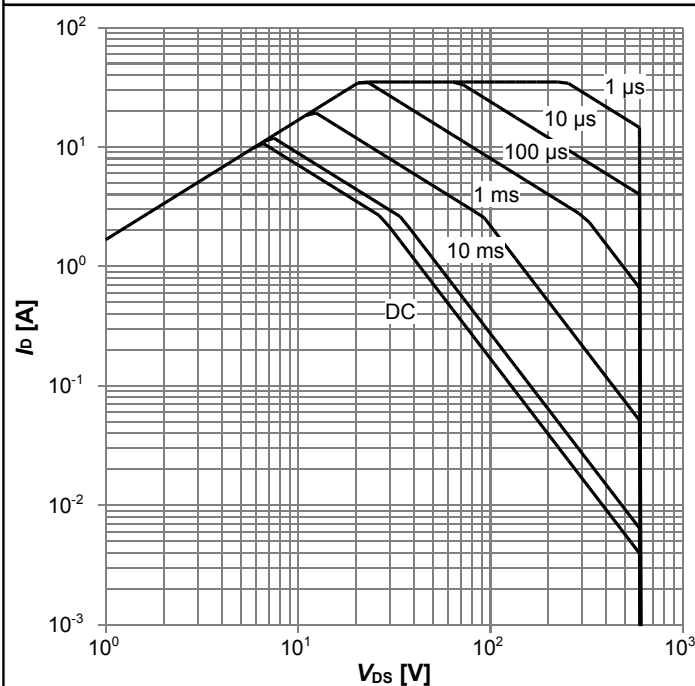

$I_D=f(V_{DS}); T_C=80\text{ °C}; D=0$ ; parameter:  $t_p$

Diagram 8: Safe operating area (FullPAK)

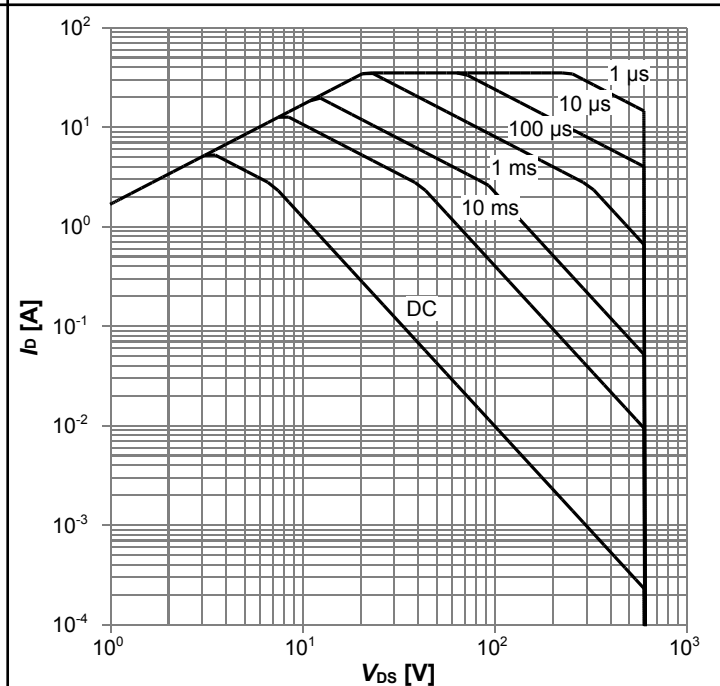

$I_D=f(V_{DS}); T_C=80\text{ °C}; D=0$ ; parameter:  $t_p$

Diagram 9: Typ. output characteristics

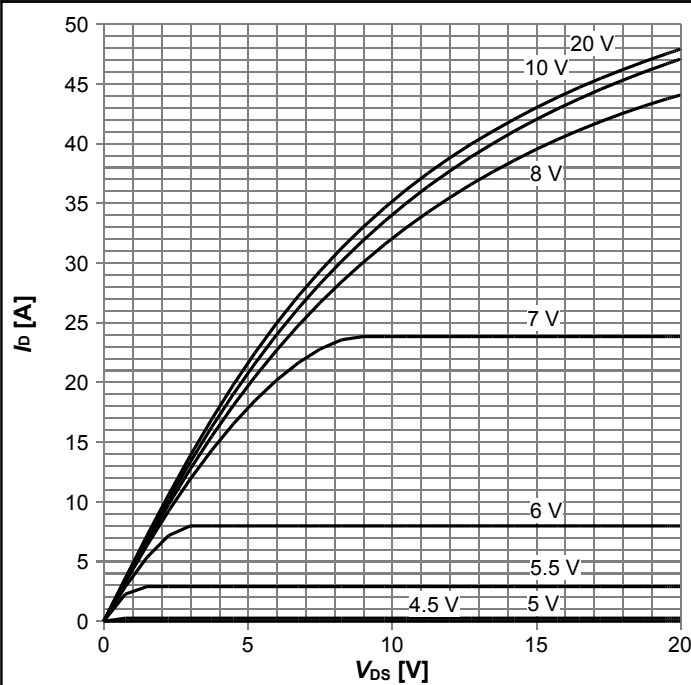

$I_D=f(V_{DS})$ ;  $T_j=25\text{ °C}$ ; parameter:  $V_{GS}$

Diagram 10: Typ. output characteristics

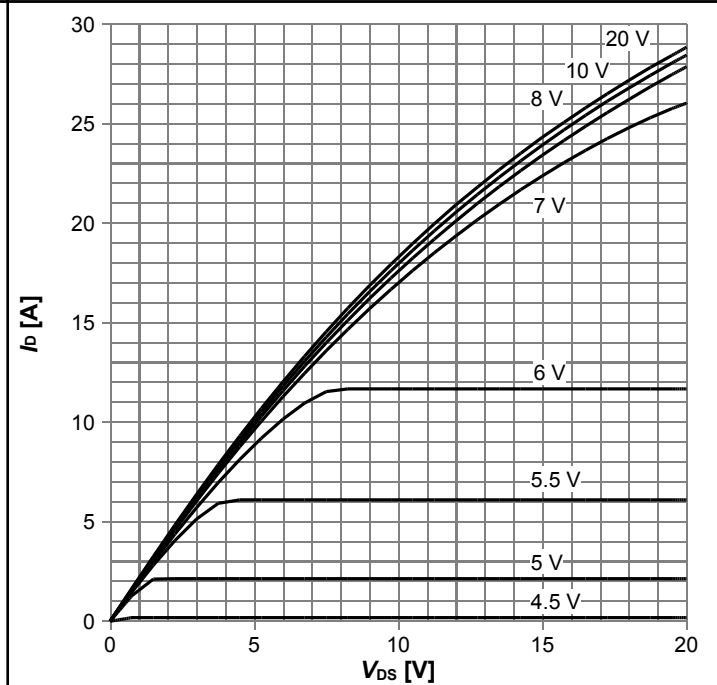

$I_D=f(V_{DS})$ ;  $T_j=125\text{ °C}$ ; parameter:  $V_{GS}$

Diagram 11: Typ. drain-source on-state resistance

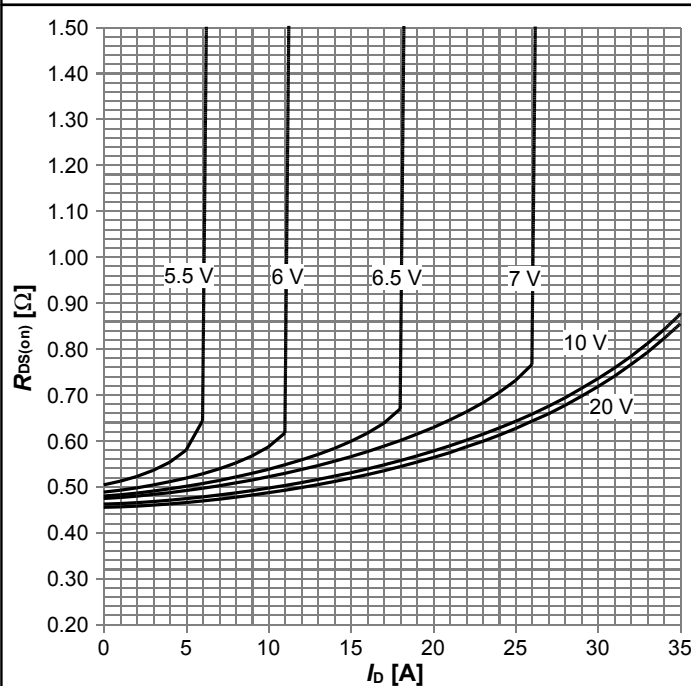

$R_{DS(on)}=f(I_D)$ ;  $T_j=125\text{ °C}$ ; parameter:  $V_{GS}$

Diagram 12: Drain-source on-state resistance

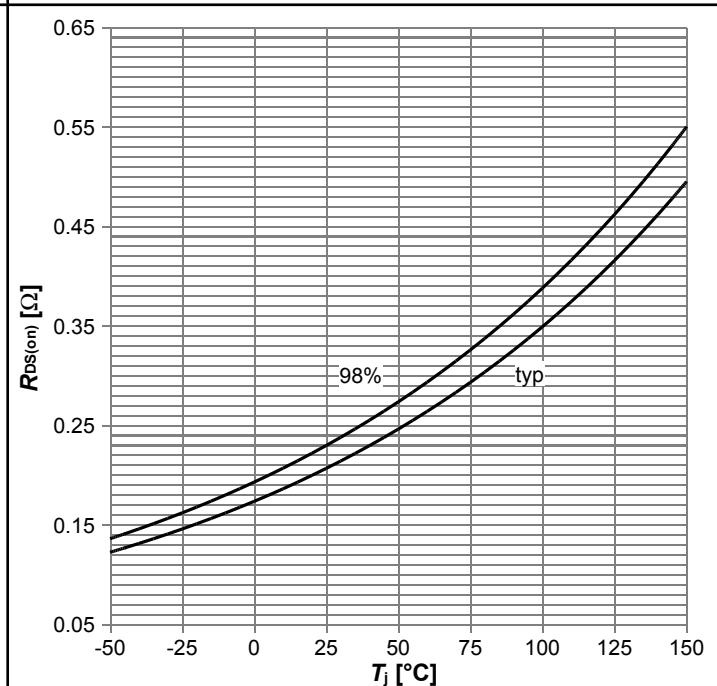

$R_{DS(on)}=f(T_j)$ ;  $I_D=6.4$  A;  $V_{GS}=10$  V

Diagram 13: Typ. transfer characteristics

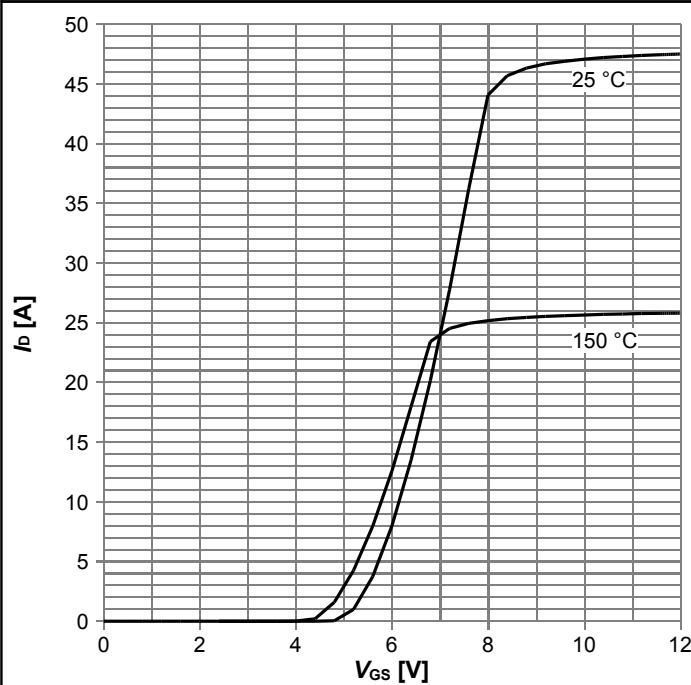

$I_D=f(V_{GS}); V_{DS}=20V; \text{parameter: } T_j$

Diagram 14: Typ. gate charge

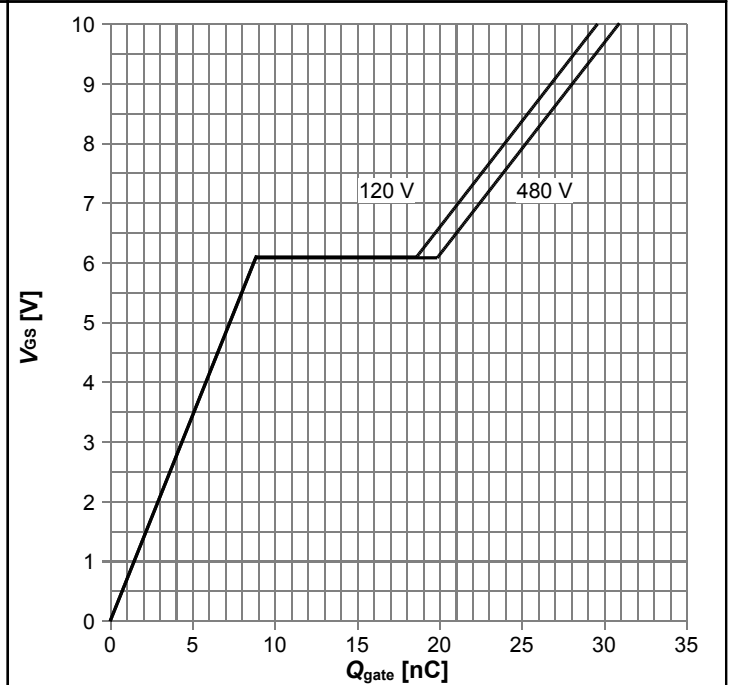

$V_{GS}=f(Q_{gate}); I_D=8.0 \text{ A pulsed}; \text{parameter: } V_{DD}$

Diagram 15: Forward characteristics of reverse diode

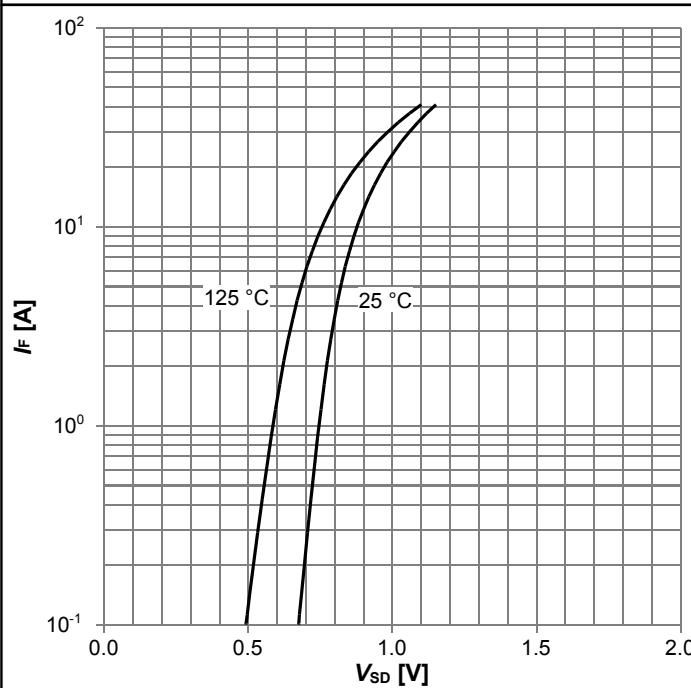

$I_F=f(V_{SD}); \text{parameter: } T_j$

Diagram 16: Avalanche energy

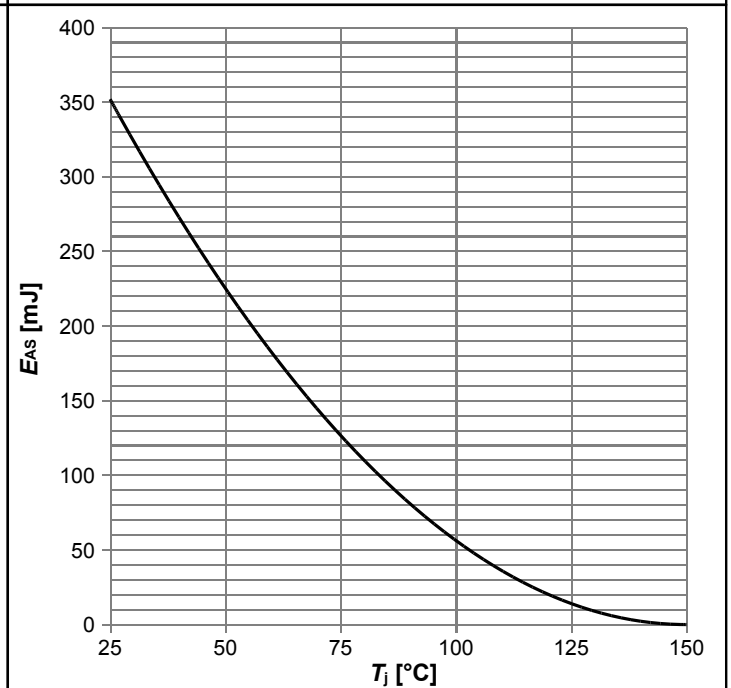

$E_{AS}=f(T_j); I_D=2.9 \text{ A}; V_{DD}=50 \text{ V}$

Diagram 17: Drain-source breakdown voltage

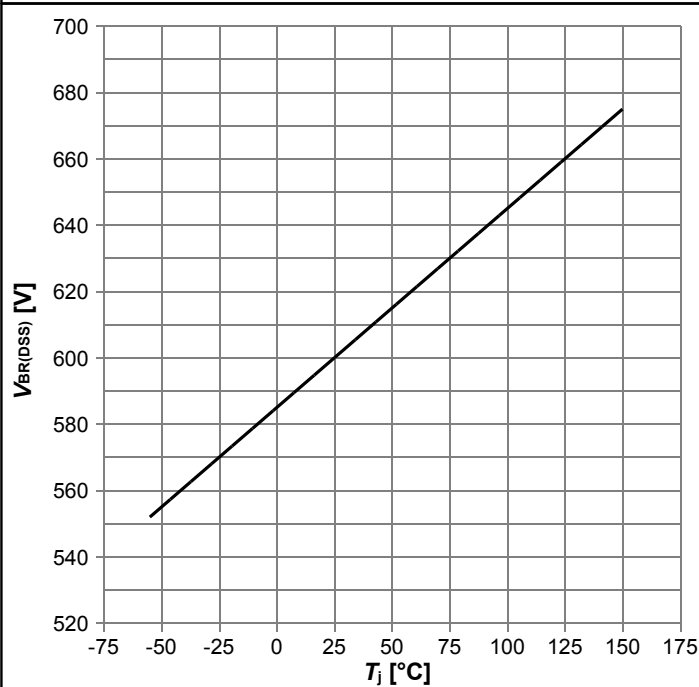

$V_{BR(DSS)}=f(T_j); I_D=1 \text{ mA}$

Diagram 18: Typ. capacitances

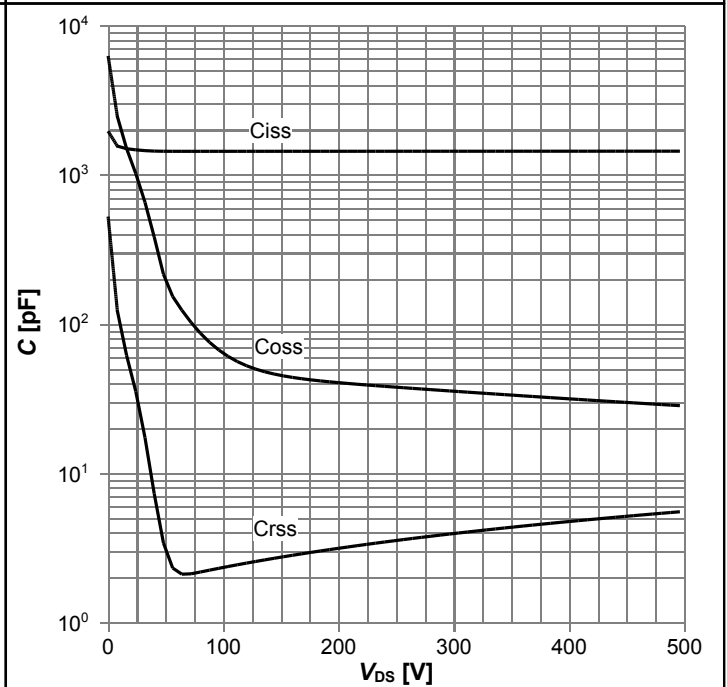

$C=f(V_{DS}); V_{GS}=0 \text{ V}; f=1 \text{ MHz}$

Diagram 19: Typ. Coss stored energy

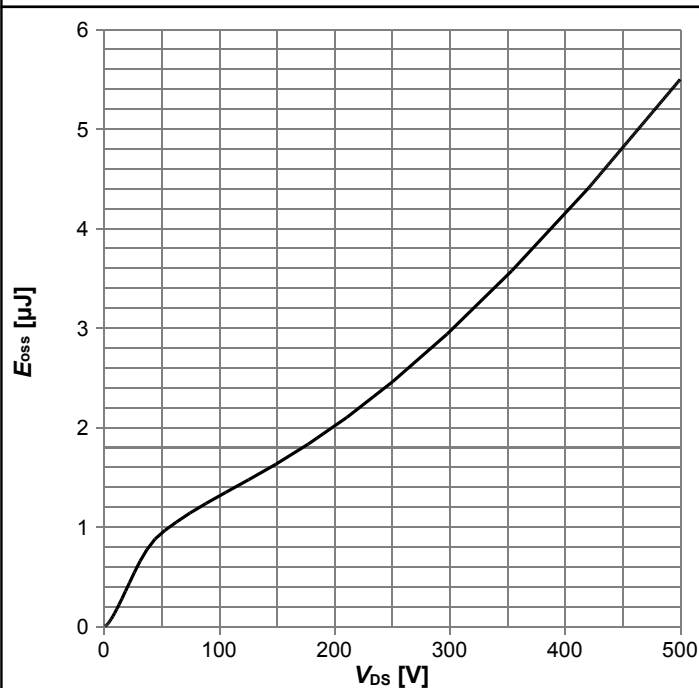

$E_{oss}=f(V_{DS})$

## 6 Test Circuits

**Table 10 Diode characteristics**

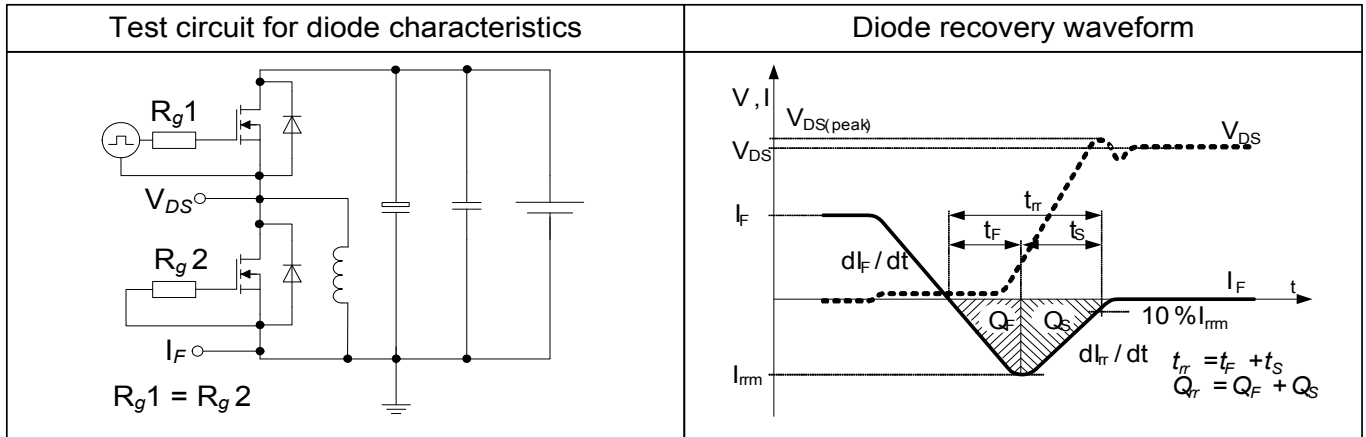

**Table 11 Switching times**

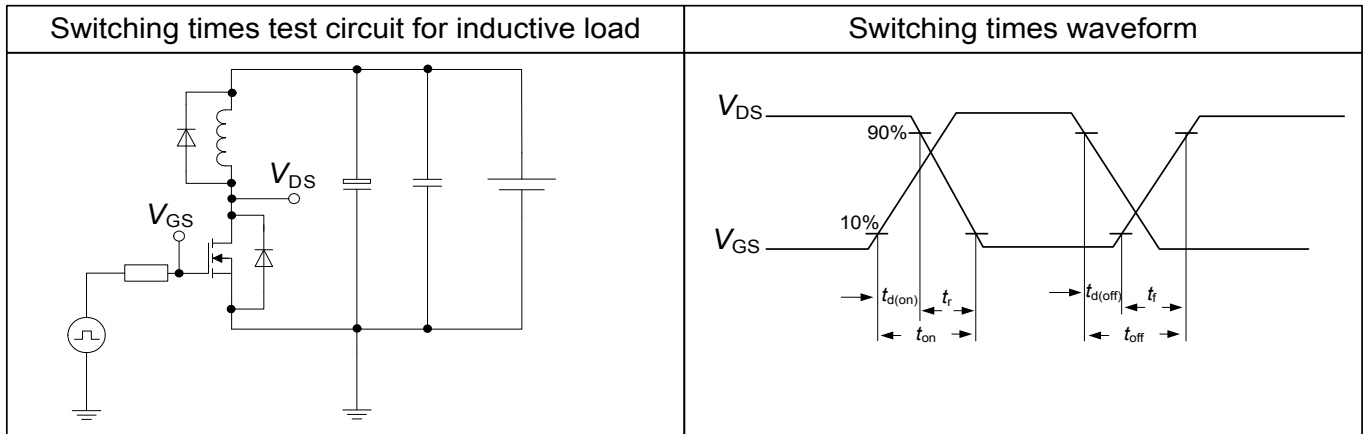

**Table 12 Unclamped inductive load**

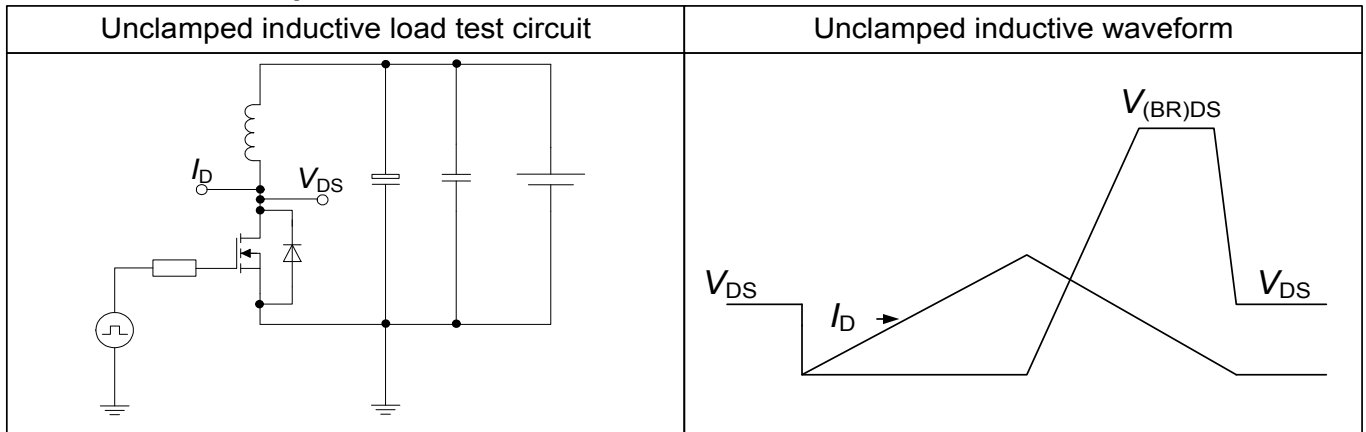

## 7 Package Outlines



Figure 1 Outline PG-TO 247, dimensions in mm/inches



Figure 2 Outline PG-TO 263, dimensions in mm/inches

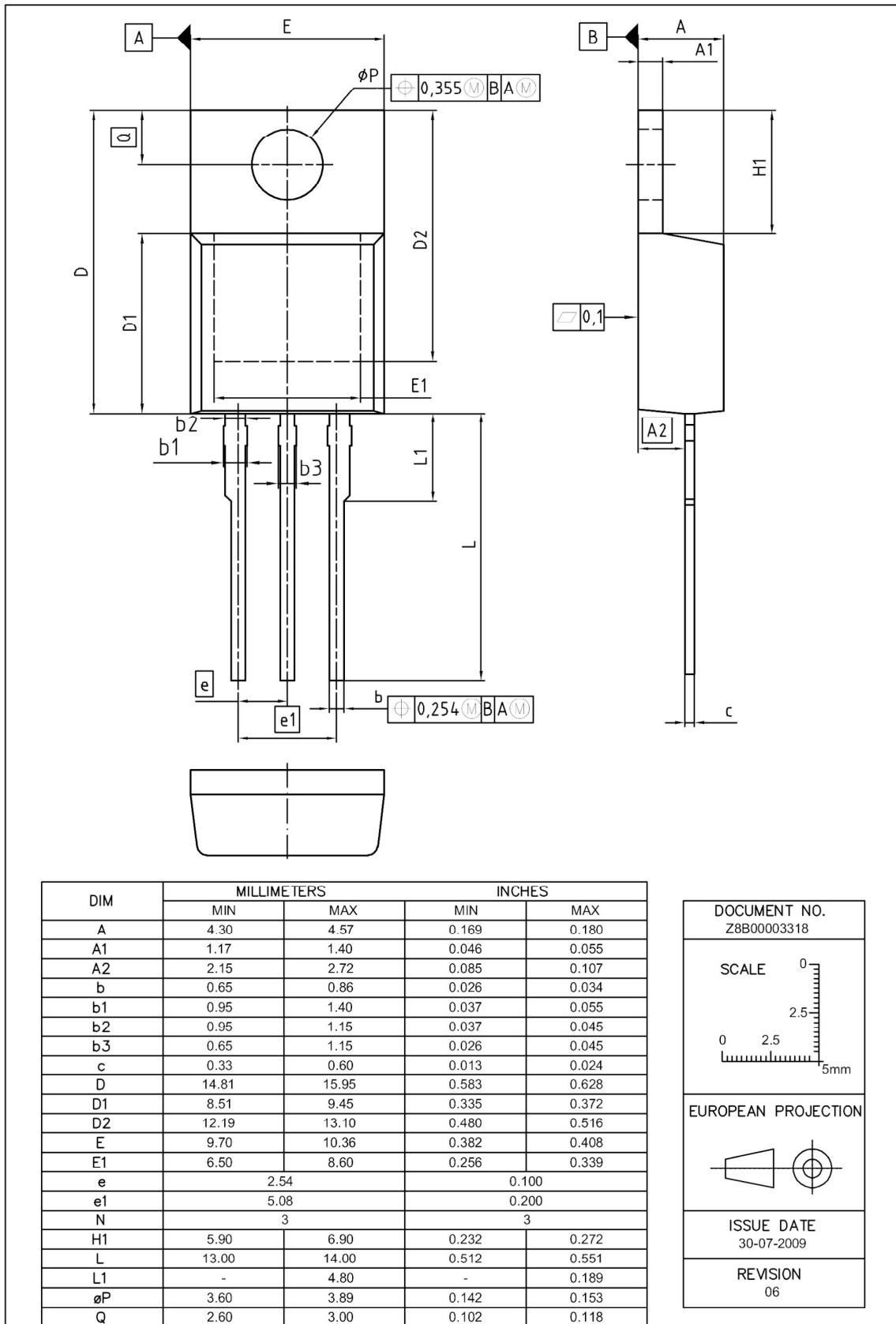
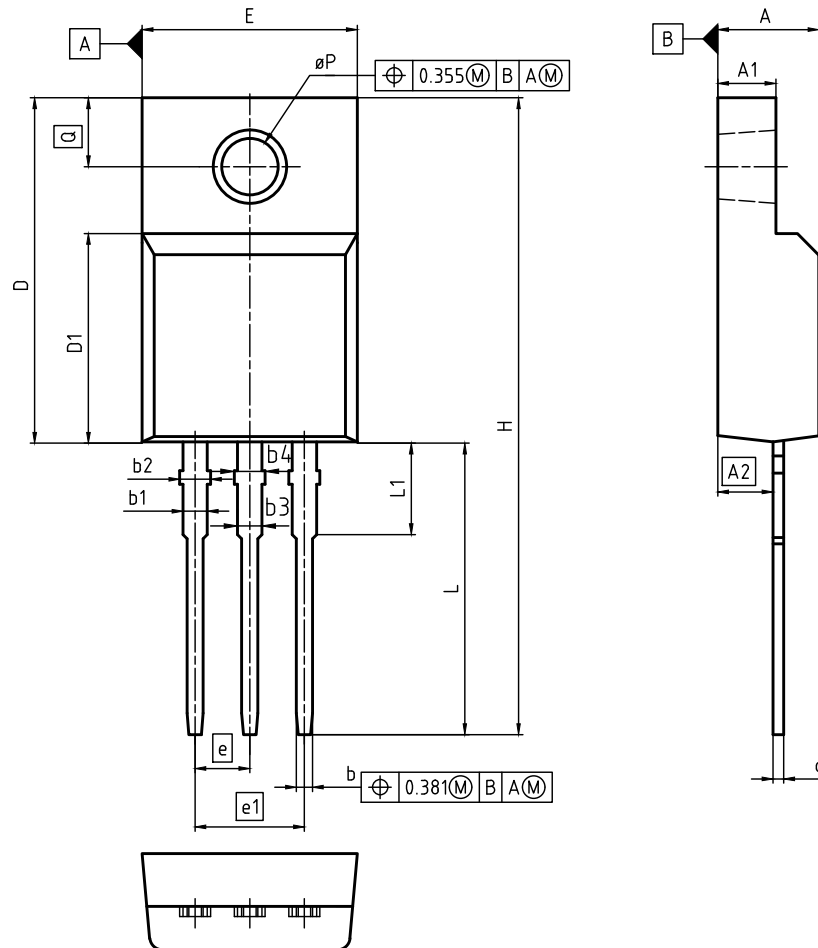

Figure 3 Outline PG-TO 220, dimensions in mm/inches





| DIM | MILLIMETERS |       | INCHES      |       |
|-----|-------------|-------|-------------|-------|
|     | MIN         | MAX   | MIN         | MAX   |
| A   | 4.50        | 4.90  | 0.177       | 0.193 |
| A1  | 2.34        | 2.85  | 0.092       | 0.112 |
| A2  | 2.42        | 2.86  | 0.095       | 0.113 |
| b   | 0.65        | 0.90  | 0.026       | 0.035 |
| b1  | 0.95        | 1.38  | 0.037       | 0.054 |
| b2  | 0.95        | 1.51  | 0.037       | 0.059 |
| b3  | 0.65        | 1.38  | 0.026       | 0.054 |
| b4  | 0.65        | 1.51  | 0.026       | 0.059 |
| c   | 0.40        | 0.63  | 0.016       | 0.025 |
| D   | 15.67       | 16.15 | 0.617       | 0.636 |
| D1  | 8.97        | 9.83  | 0.353       | 0.387 |
| E   | 10.00       | 10.65 | 0.394       | 0.419 |
| e   | 2.54 (BSC)  |       | 0.100 (BSC) |       |
| e1  | 5.08        |       | 0.200       |       |
| N   | 3           |       | 3           |       |
| H   | 28.70       | 29.75 | 1.130       | 1.171 |
| L   | 12.78       | 13.75 | 0.503       | 0.541 |
| L1  | 2.83        | 3.45  | 0.111       | 0.136 |
| øP  | 2.95        | 3.38  | 0.116       | 0.133 |
| Q   | 3.15        | 3.50  | 0.124       | 0.138 |

DOCUMENT NO.  
Z8B00003319

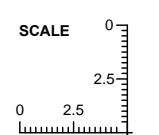
SCALE 

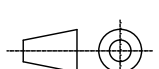
EUROPEAN PROJECTION 

ISSUE DATE  
05-05-2014

REVISION  
04

Figure 4 Outline PG-TO 220 FullPAK, dimensions in mm/inches

## 8 Appendix A

### Table 13 Related Links

- IFX CoolMOS™ P6 Webpage: [www.infineon.com](http://www.infineon.com)
- IFX CoolMOS™ P6 application note: [www.infineon.com](http://www.infineon.com)
- IFX CoolMOS™ P6 simulation model: [www.infineon.com](http://www.infineon.com)
- IFX Design tools: [www.infineon.com](http://www.infineon.com)

## Revision History

IPW60R230P6, IPB60R230P6, IPP60R230P6, IPA60R230P6

**Revision: 2015-07-10, Rev. 2.2**

Previous Revision

| Revision | Date       | Subjects (major changes since last revision) |
|----------|------------|--|
| 2.0      | 2013-12-04 | Release of final version                     |
| 2.1      | 2013-12-05 | Release of multi-package datasheet           |
| 2.2      | 2015-07-10 | PG-TO 263 package added                      |

### We Listen to Your Comments

Any information within this document that you feel is wrong, unclear or missing at all? Your feedback will help us to continuously improve the quality of this document. Please send your proposal (including a reference to this document) to:

[erratum@infineon.com](mailto:erratum@infineon.com)

### Published by

**Infineon Technologies AG**  
**81726 München, Germany**  
 © 2015 Infineon Technologies AG  
 All Rights Reserved.

### Legal Disclaimer

The information given in this document shall in no event be regarded as a guarantee of conditions or characteristics. With respect to any examples or hints given herein, any typical values stated herein and/or any information regarding the application of the device, Infineon Technologies hereby disclaims any and all warranties and liabilities of any kind, including without limitation, warranties of non-infringement of intellectual property rights of any third party.

### Information

For further information on technology, delivery terms and conditions and prices please contact your nearest Infineon Technologies Office ([www.infineon.com](http://www.infineon.com)).

### Warnings

Due to technical requirements, components may contain dangerous substances. For information on the types in question, please contact the nearest Infineon Technologies Office.

The Infineon Technologies component described in this Data Sheet may be used in life-support devices or systems and/or automotive, aviation and aerospace applications or systems only with the express written approval of Infineon Technologies, if a failure of such components can reasonably be expected to cause the failure of that life-support, automotive, aviation and aerospace device or system or to affect the safety or effectiveness of that device or system. Life support devices or systems are intended to be implanted in the human body or to support and/or maintain and sustain and/or protect human life. If they fail, it is reasonable to assume that the health of the user or other persons may be endangered.

# Mouser Electronics

Authorized Distributor

Click to View Pricing, Inventory, Delivery & Lifecycle Information:

[Infineon:](#)

[IPA60R230P6XKSA1](#) [IPP60R230P6XKSA1](#) [IPW60R230P6FKSA1](#) [IPP60R230P6](#)