

MOSFET

600V CoolMOS™ PFD7 SJ Power Device

CoolMOS™ is a revolutionary technology for high voltage power MOSFETs, designed according to the superjunction (SJ) principle and pioneered by Infineon Technologies.

The latest CoolMOS™ PFD7 is an optimized platform tailored to target cost sensitive applications in consumer markets such as charger, adapter, motor drive, lighting, etc.

The new series provides all the benefits of a fast switching Superjunction MOSFET, combined with an excellent price/performance ratio and state of the art ease-of-use level. The technology meets highest efficiency standards and supports high power density, enabling customers going towards very slim designs.



Features

- Extremely low losses due to very low FOM $R_{DS(on)} * Q_g$ and $R_{DS(on)} * E_{oss}$
- Low switching losses E_{oss} , excellent thermal behavior
- Fast body diode
- Wide range portfolio of $R_{DS(on)}$ and package variations
- Integrated zener diode

Benefits

- Enables high power density designs and small form factors
- Enables efficiency gains at higher switching frequencies
- Excellent commutation ruggedness
- Easy to select right parts and optimize the design
- High ESD ruggedness

Potential applications

Recommended for ZVS topologies used in high density chargers, adapters, lighting and motor drives applications, etc.

Product validation

Qualified according to JEDEC Standard

Please note: For MOSFET paralleling the use of ferrite beads on the gate or separate totem poles is generally recommended.

Table 1 Key Performance Parameters

| Parameter | Value | Unit |
|----------------------|-------|------|
| $V_{DS} @ T_{j,max}$ | 650 | V |
| $R_{DS(on),max}$ | 360 | mΩ |
| $Q_{g,typ}$ | 12.7 | nC |
| $I_{D,pulse}$ | 24 | A |
| $E_{oss} @ 400V$ | 1.6 | μJ |
| Body diode di_f/dt | 1300 | A/μs |
| ESD Class (HBM) | 2 | - |

| Type / Ordering Code | Package | Marking | Related Links |
|----------------------|-------------|----------|----------------|
| IPS60R360PFD7S | PG-TO 251-3 | 60S360D7 | see Appendix A |

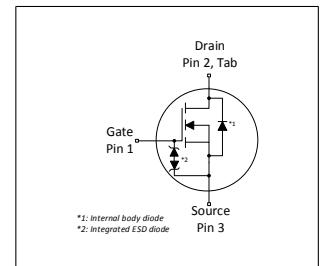

Table of Contents

| | |
|---|----|
| Description | 1 |
| Maximum ratings | 3 |
| Thermal characteristics | 4 |
| Electrical characteristics | 5 |
| Electrical characteristics diagrams | 7 |
| Test Circuits | 11 |
| Package Outlines | 12 |
| Appendix A | 13 |
| Revision History | 14 |
| Trademarks | 14 |
| Disclaimer | 14 |

1 Maximum ratings

at $T_j = 25^\circ\text{C}$, unless otherwise specified

Table 2 Maximum ratings

| Parameter | Symbol | Values | | | Unit | Note / Test Condition |
|--|---------------------|--------|------|---------|------------------|---|
| | | Min. | Typ. | Max. | | |
| Continuous drain current ¹⁾ | I_D | - | - | 10 6 | A | $T_C=25^\circ\text{C}$ $T_C=100^\circ\text{C}$ |
| Pulsed drain current ²⁾ | $I_{D,pulse}$ | - | - | 24 | A | $T_C=25^\circ\text{C}$ |
| Avalanche energy, single pulse | E_{AS} | - | - | 29 | mJ | $I_D=2.1\text{A}$; $V_{DD}=50\text{V}$; see table 10 |
| Avalanche energy, repetitive | E_{AR} | - | - | 0.14 | mJ | $I_D=2.1\text{A}$; $V_{DD}=50\text{V}$; see table 10 |
| Avalanche current, single pulse | I_{AS} | - | - | 2.1 | A | - |
| MOSFET dv/dt ruggedness | dv/dt | - | - | 120 | V/ns | $V_{DS}=0\dots400\text{V}$ |
| Gate source voltage (static) | V_{GS} | -20 | - | 20 | V | static; |
| Gate source voltage (dynamic) | V_{GS} | -30 | - | 30 | V | AC ($f>1\text{ Hz}$) |
| Power dissipation | P_{tot} | - | - | 43 | W | $T_C=25^\circ\text{C}$ |
| Storage temperature | T_{stg} | -40 | - | 150 | $^\circ\text{C}$ | - |
| Operating junction temperature | T_j | -40 | - | 150 | $^\circ\text{C}$ | - |
| Mounting torque | - | - | - | - | Ncm | - |
| Continuous diode forward current ¹⁾ | I_S | - | - | 10 | A | $T_C=25^\circ\text{C}$ |
| Diode pulse current ²⁾ | $I_{S,pulse}$ | - | - | 24 | A | $T_C=25^\circ\text{C}$ |
| Reverse diode dv/dt ³⁾ | dv/dt | - | - | 70 | V/ns | $V_{DS}=0\dots400\text{V}$, $I_{SD}\leq 7.2\text{A}$, $T_j=25^\circ\text{C}$ see table 8 |
| Maximum diode commutation speed | di _F /dt | - | - | 1300 | A/ μs | $V_{DS}=0\dots400\text{V}$, $I_{SD}\leq 7.2\text{A}$, $T_j=25^\circ\text{C}$ see table 8 |
| Insulation withstand voltage | V_{ISO} | - | - | n.a. | V | V_{rms} , $T_C=25^\circ\text{C}$, $t=1\text{min}$ |

¹⁾ Limited by $T_{j,max}$. Maximum Duty Cycle $D = 0.50$

²⁾ Pulse width t_p limited by $T_{j,max}$

³⁾ Identical low side and high side switch with identical R_θ

2 Thermal characteristics

Table 3 Thermal characteristics

| Parameter | Symbol | Values | | | Unit | Note / Test Condition |
|--|------------|--------|------|------|------|-------------------------------------|
| | | Min. | Typ. | Max. | | |
| Thermal resistance, junction - case | R_{thJC} | - | - | 2.89 | °C/W | - |
| Thermal resistance, junction - ambient | R_{thJA} | - | - | 62 | °C/W | leaded |
| Thermal resistance, junction - ambient for SMD version | R_{thJA} | - | - | - | °C/W | n.a. |
| Soldering temperature, wavesoldering only allowed at leads | T_{sold} | - | - | 260 | °C | 1.6mm (0.063 in.) from case for 10s |

3 Electrical characteristics

at $T_j=25^\circ\text{C}$, unless otherwise specified

Table 4 Static characteristics

| Parameter | Symbol | Values | | | Unit | Note / Test Condition |
|---|---------------|--------|----------------|-------|---------------|---|
| | | Min. | Typ. | Max. | | |
| Drain-source breakdown voltage | $V_{(BR)DSS}$ | 600 | - | - | V | $V_{GS}=0\text{V}$, $I_D=1\text{mA}$ |
| Gate threshold voltage | $V_{(GS)th}$ | 3.5 | 4 | 4.5 | V | $V_{DS}=V_{GS}$, $I_D=0.14\text{mA}$ |
| Zero gate voltage drain current ¹⁾ | I_{DSS} | - | - | 1 | μA | $V_{DS}=600\text{V}$, $V_{GS}=0\text{V}$, $T_j=25^\circ\text{C}$ $V_{DS}=600\text{V}$, $V_{GS}=0\text{V}$, $T_j=125^\circ\text{C}$ |
| Gate-source leakage current | I_{GSS} | - | - | 1000 | nA | $V_{GS}=20\text{V}$, $V_{DS}=0\text{V}$ |
| Drain-source on-state resistance | $R_{DS(on)}$ | - | 0.303 0.714 | 0.360 | Ω | $V_{GS}=10\text{V}$, $I_D=2.9\text{A}$, $T_j=25^\circ\text{C}$ $V_{GS}=10\text{V}$, $I_D=2.9\text{A}$, $T_j=150^\circ\text{C}$ |
| Gate resistance | R_G | - | 11.0 | - | Ω | $f=1\text{MHz}$, open drain |

Table 5 Dynamic characteristics

| Parameter | Symbol | Values | | | Unit | Note / Test Condition |
|--|--------------|--------|------|------|------|--|
| | | Min. | Typ. | Max. | | |
| Input capacitance | C_{iss} | - | 534 | - | pF | $V_{GS}=0\text{V}$, $V_{DS}=400\text{V}$, $f=250\text{kHz}$ |
| Output capacitance | C_{oss} | - | 12 | - | pF | $V_{GS}=0\text{V}$, $V_{DS}=400\text{V}$, $f=250\text{kHz}$ |
| Effective output capacitance, energy related ²⁾ | $C_{o(er)}$ | - | 20 | - | pF | $V_{GS}=0\text{V}$, $V_{DS}=0\dots400\text{V}$ |
| Effective output capacitance, time related ³⁾ | $C_{o(tr)}$ | - | 187 | - | pF | $I_D=\text{constant}$, $V_{GS}=0\text{V}$, $V_{DS}=0\dots400\text{V}$ |
| Turn-on delay time | $t_{d(on)}$ | - | 13.5 | - | ns | $V_{DD}=400\text{V}$, $V_{GS}=10\text{V}$, $I_D=2.9\text{A}$, $R_G=10.2\Omega$; see table 9 |
| Rise time | t_r | - | 11 | - | ns | $V_{DD}=400\text{V}$, $V_{GS}=10\text{V}$, $I_D=2.9\text{A}$, $R_G=10.2\Omega$; see table 9 |
| Turn-off delay time | $t_{d(off)}$ | - | 46 | - | ns | $V_{DD}=400\text{V}$, $V_{GS}=10\text{V}$, $I_D=2.9\text{A}$, $R_G=10.2\Omega$; see table 9 |
| Fall time | t_f | - | 13 | - | ns | $V_{DD}=400\text{V}$, $V_{GS}=10\text{V}$, $I_D=2.9\text{A}$, $R_G=10.2\Omega$; see table 9 |

Table 6 Gate charge characteristics

| Parameter | Symbol | Values | | | Unit | Note / Test Condition |
|-----------------------|---------------|--------|------|------|------|---|
| | | Min. | Typ. | Max. | | |
| Gate to source charge | Q_{GS} | - | 3.0 | - | nC | $V_{DD}=400\text{V}$, $I_D=2.9\text{A}$, $V_{GS}=0$ to 10V |
| Gate to drain charge | Q_{gd} | - | 4.4 | - | nC | $V_{DD}=400\text{V}$, $I_D=2.9\text{A}$, $V_{GS}=0$ to 10V |
| Gate charge total | Q_g | - | 12.7 | - | nC | $V_{DD}=400\text{V}$, $I_D=2.9\text{A}$, $V_{GS}=0$ to 10V |
| Gate plateau voltage | $V_{plateau}$ | - | 5.6 | - | V | $V_{DD}=400\text{V}$, $I_D=2.9\text{A}$, $V_{GS}=0$ to 10V |

¹⁾ Maximum specification is defined by calculated six sigma upper confidence bound

²⁾ $C_{o(er)}$ is a fixed capacitance that gives the same stored energy as C_{oss} while V_{DS} is rising from 0 to 400V

³⁾ $C_{o(tr)}$ is a fixed capacitance that gives the same charging time as C_{oss} while V_{DS} is rising from 0 to 400V

Table 7 Reverse diode characteristics

| Parameter | Symbol | Values | | | Unit | Note / Test Condition |
|-------------------------------|-----------|--------|------|------|---------|---|
| | | Min. | Typ. | Max. | | |
| Diode forward voltage | V_{SD} | - | 1.0 | - | V | $V_{GS}=0V, I_F=2.9A, T_j=25^\circ C$ |
| Reverse recovery time | t_{rr} | - | 60 | 90 | ns | $V_R=400V, I_F=2.9A, di_F/dt=100A/\mu s$; see table 8 |
| Reverse recovery charge | Q_{rr} | - | 0.14 | 0.28 | μC | $V_R=400V, I_F=2.9A, di_F/dt=100A/\mu s$; see table 8 |
| Peak reverse recovery current | I_{rrm} | - | 4.1 | - | A | $V_R=400V, I_F=2.9A, di_F/dt=100A/\mu s$; see table 8 |

4 Electrical characteristics diagrams

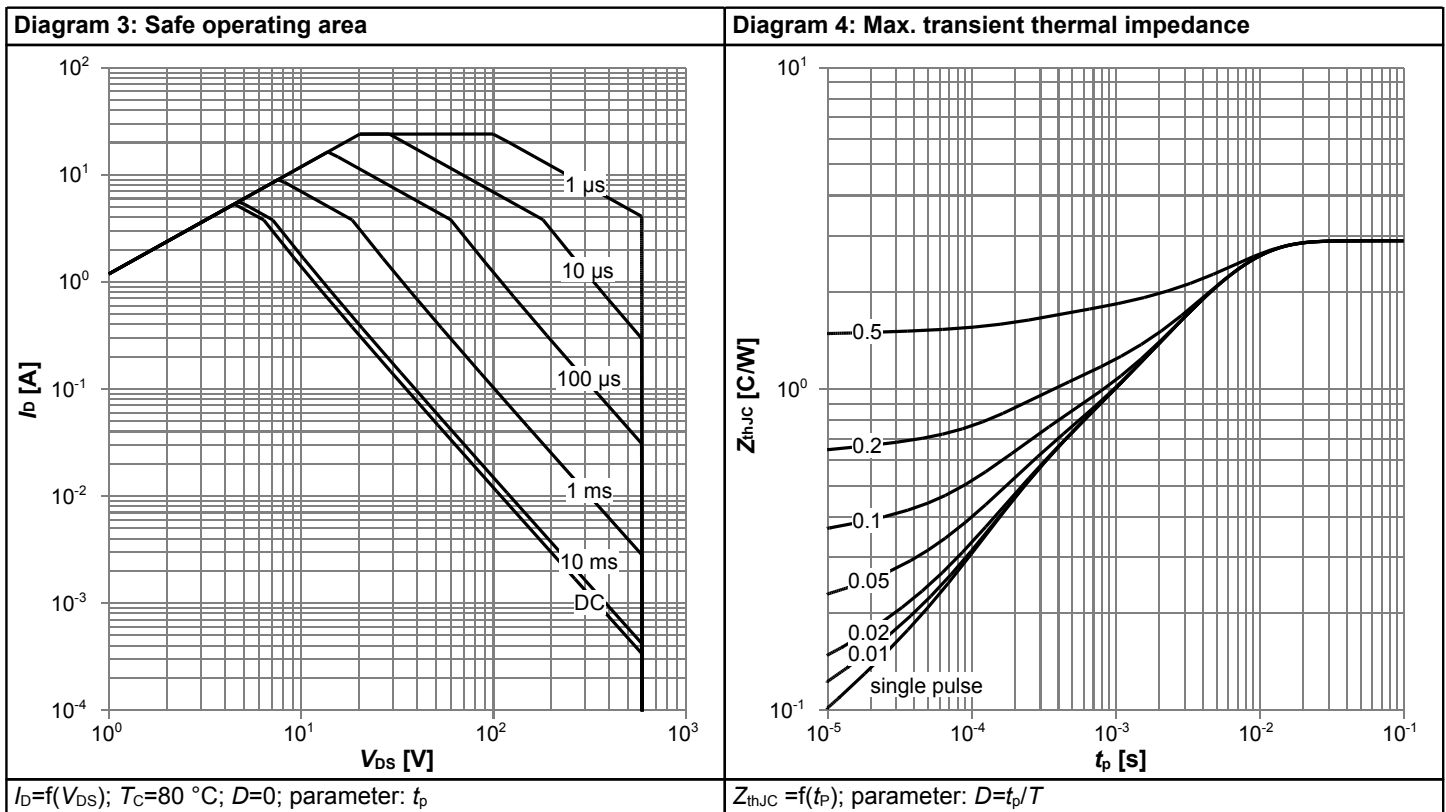
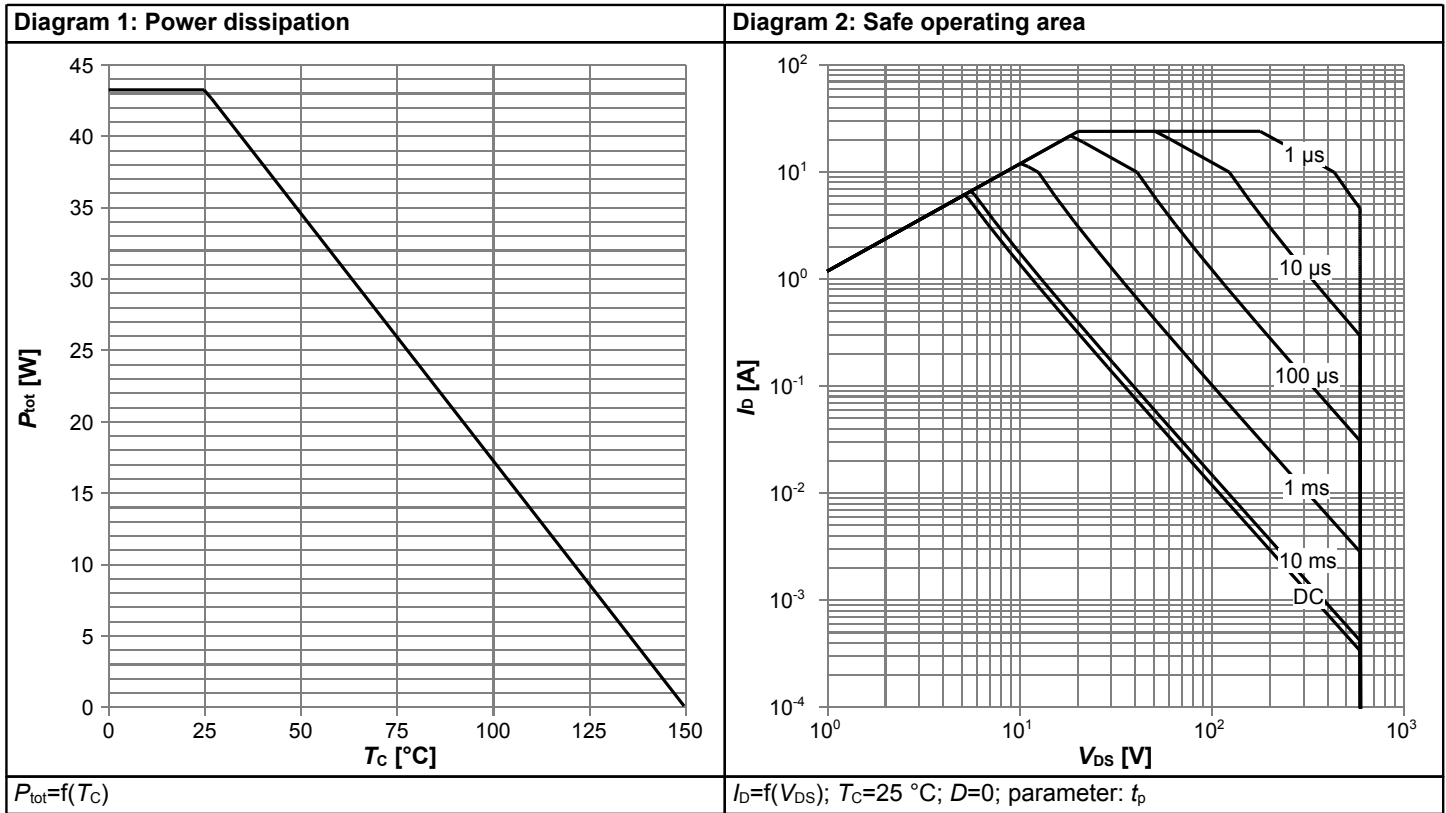
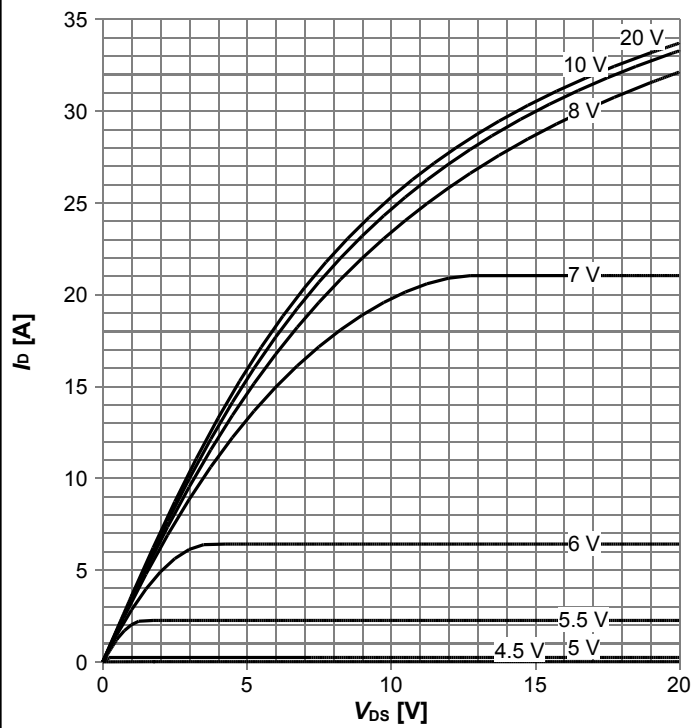
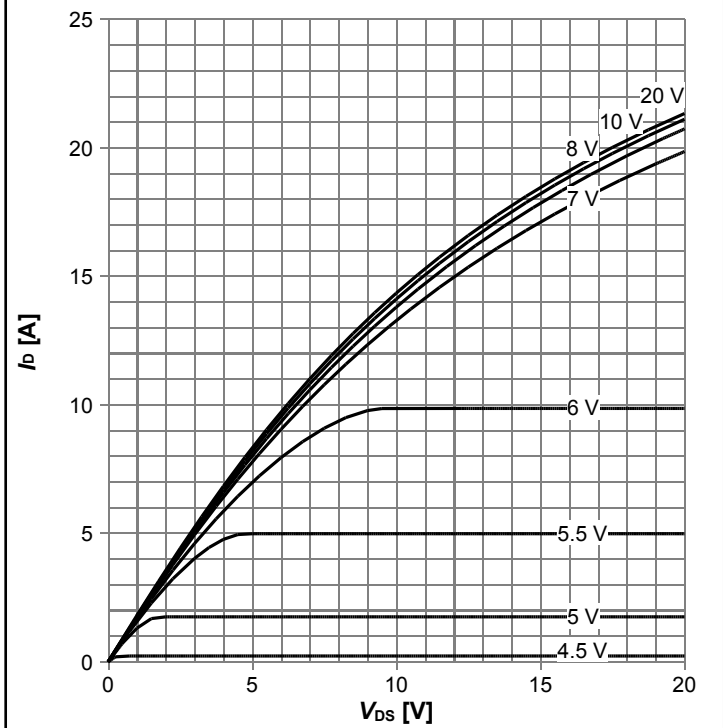

Diagram 5: Typ. output characteristics



$I_D=f(V_{DS})$; $T_j=25\text{ °C}$; parameter: V_{GS}

Diagram 6: Typ. output characteristics



$I_D=f(V_{DS})$; $T_j=125\text{ °C}$; parameter: V_{GS}

Diagram 7: Typ. drain-source on-state resistance

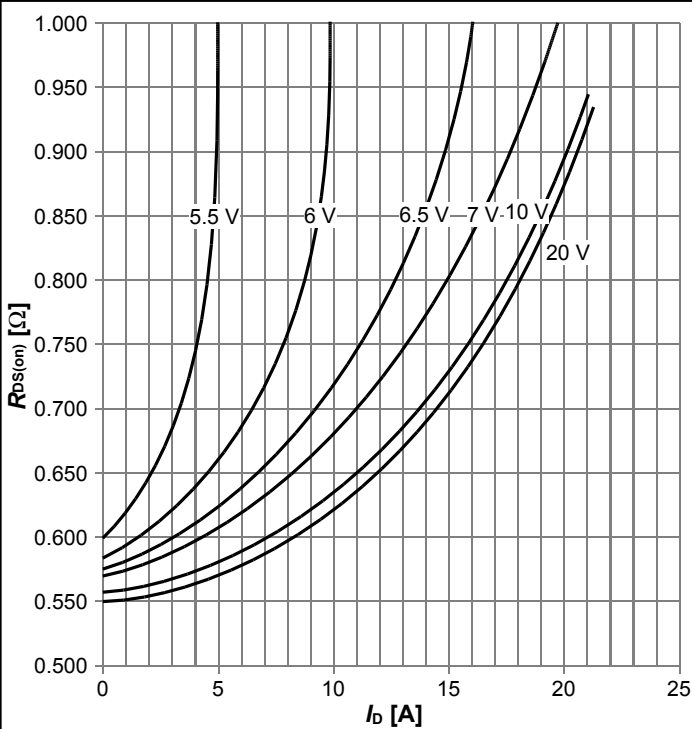

$R_{DS(on)}=f(I_D)$; $T_j=125\text{ °C}$; parameter: V_{GS}

Diagram 8: Drain-source on-state resistance

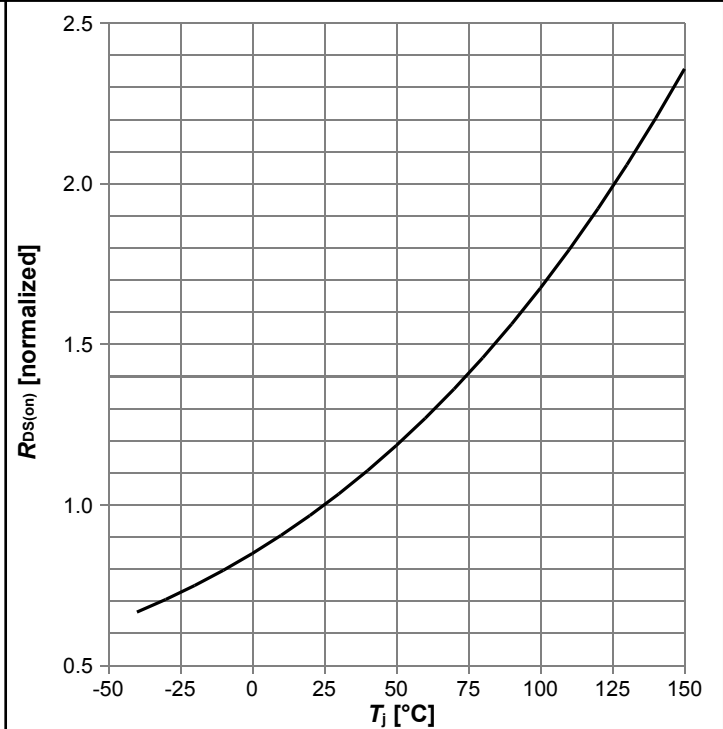

$R_{DS(on)}=f(T_j)$; $I_D=2.9\text{ A}$; $V_{GS}=10\text{ V}$

Diagram 9: Typ. transfer characteristics

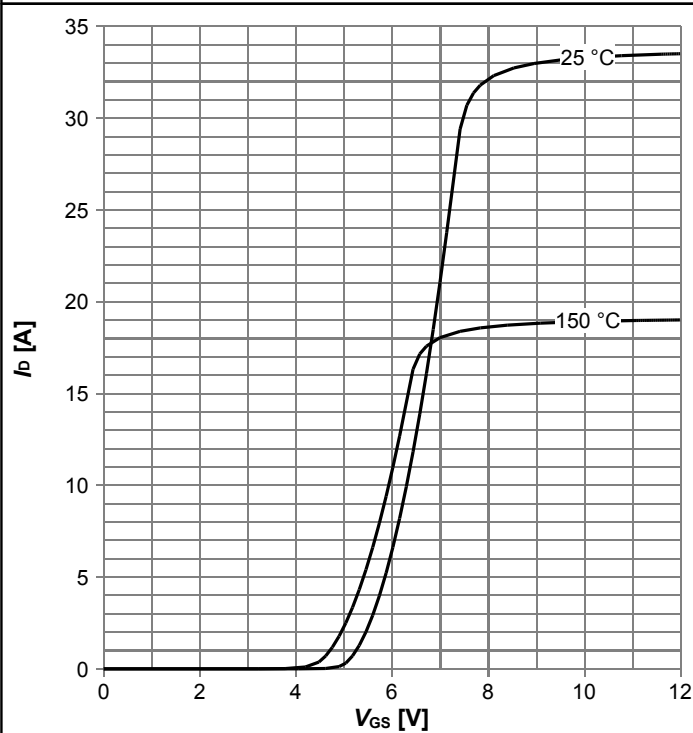

$I_D = f(V_{GS}); V_{DS} = 20V; \text{parameter: } T_j$

Diagram 10: Typ. gate charge

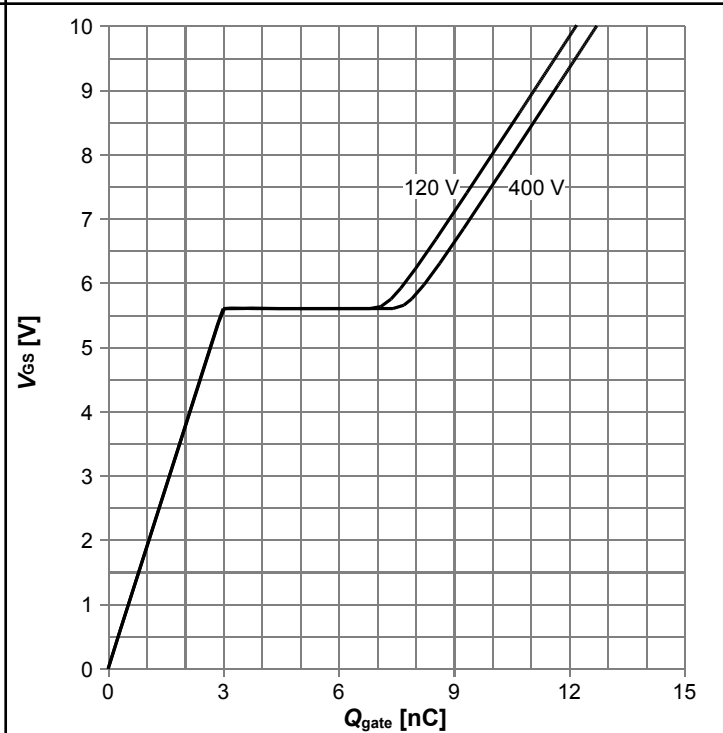

$V_{GS} = f(Q_{gate}); I_D = 2.9 \text{ A pulsed}; \text{parameter: } V_{DD}$

Diagram 11: Forward characteristics of reverse diode

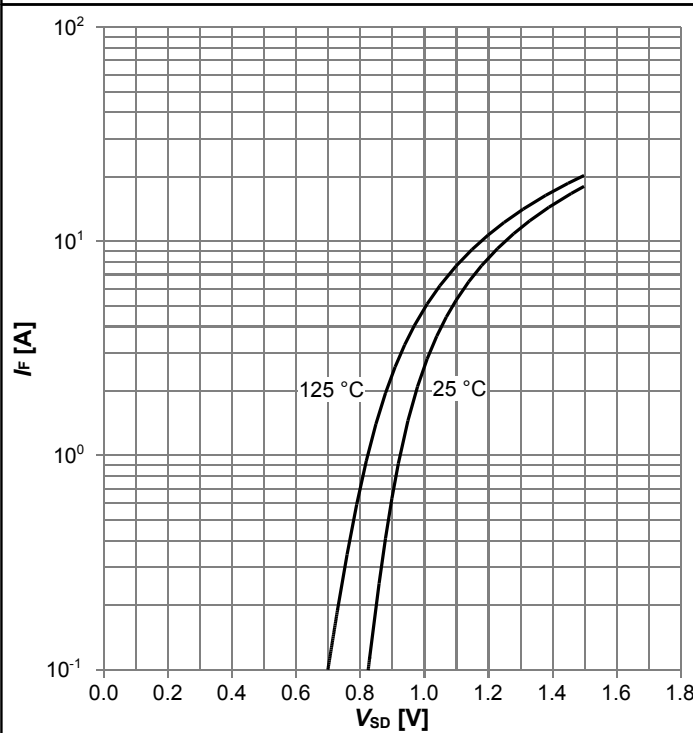

$I_F = f(V_{SD}); \text{parameter: } T_j$

Diagram 12: Avalanche energy

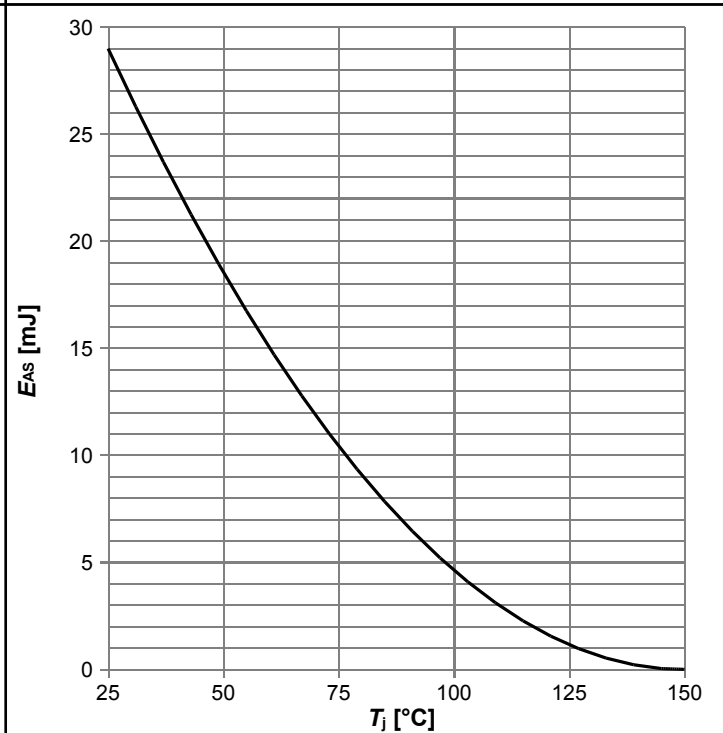

$E_{AS} = f(T_j); I_D = 2.1 \text{ A}; V_{DD} = 50 \text{ V}$

Diagram 13: Drain-source breakdown voltage

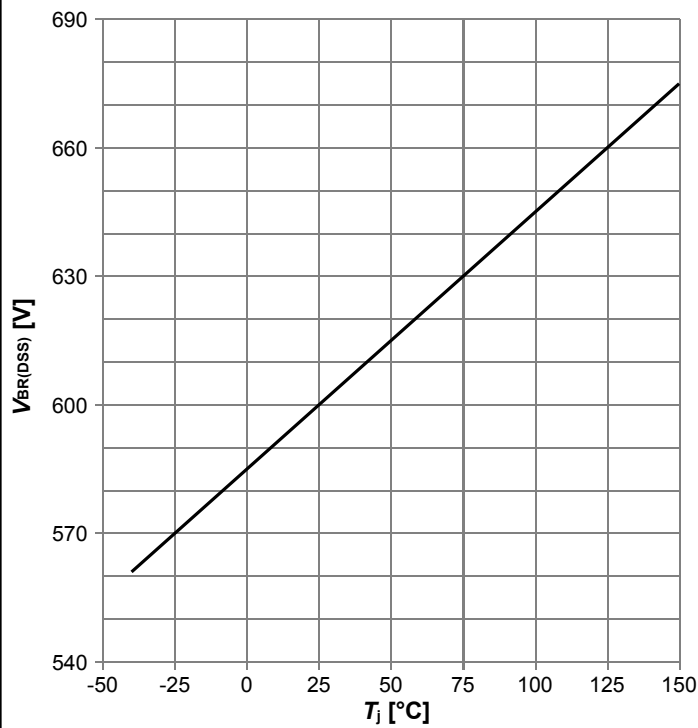

$V_{BR(DSS)}=f(T_j); I_D=1\text{ mA}$

Diagram 14: Typ. capacitances

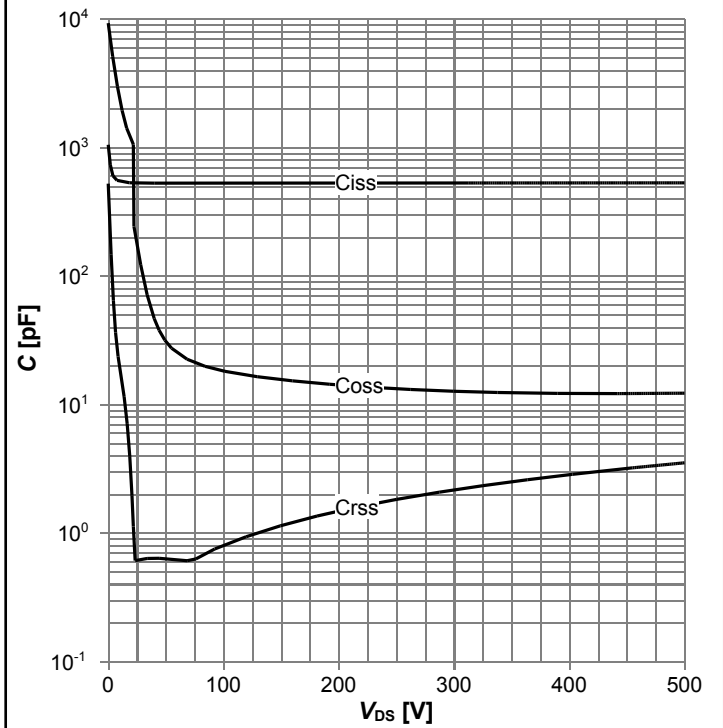

$C=f(V_{DS}); V_{GS}=0\text{ V}; f=250\text{ kHz}$

Diagram 15: Typ. Coss stored energy

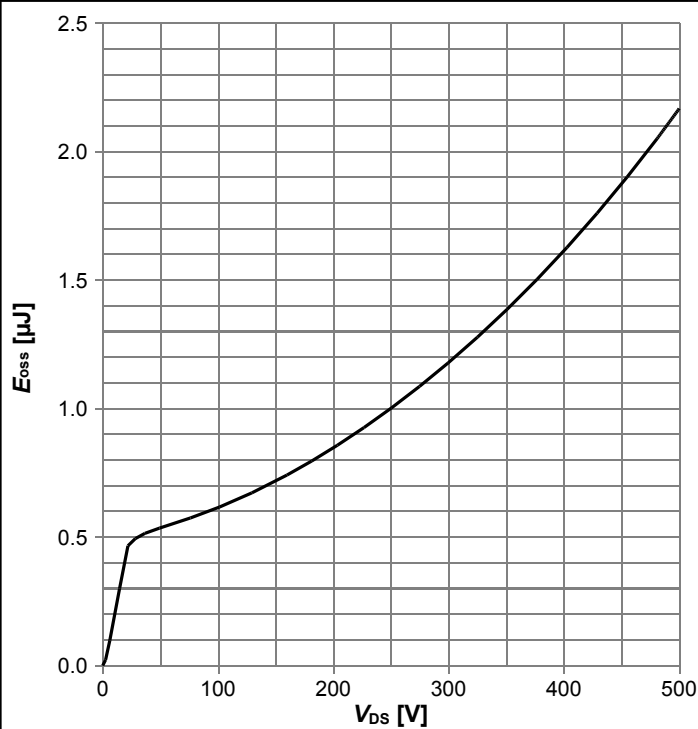

$E_{oss}=f(V_{DS})$

5 Test Circuits

Table 8 Diode characteristics



Table 9 Switching times

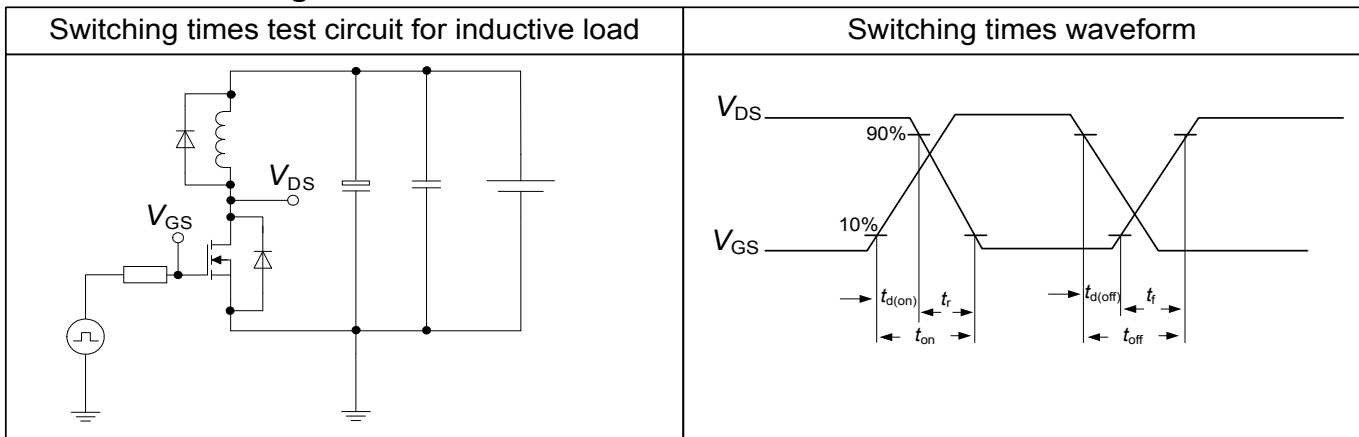
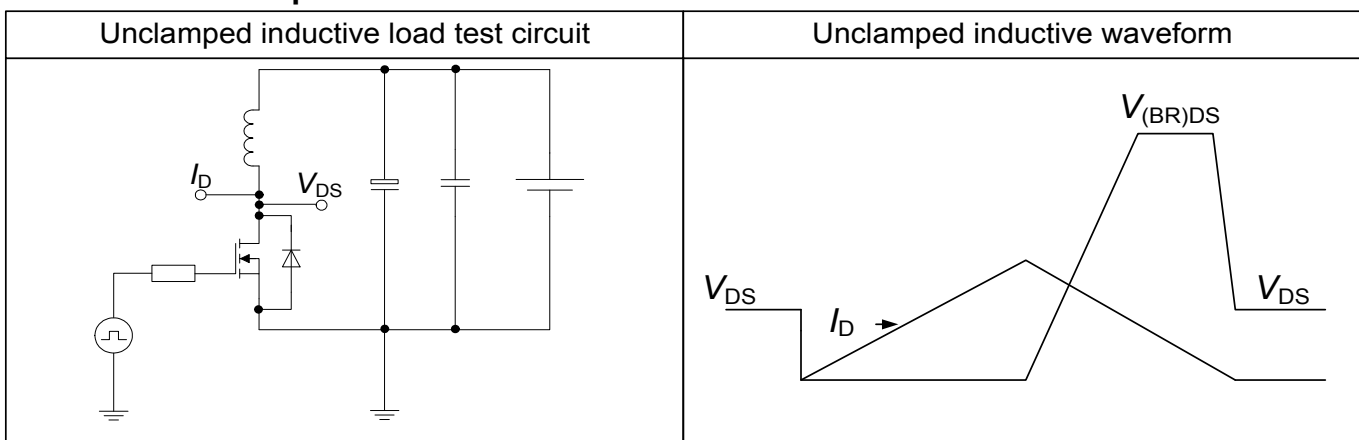
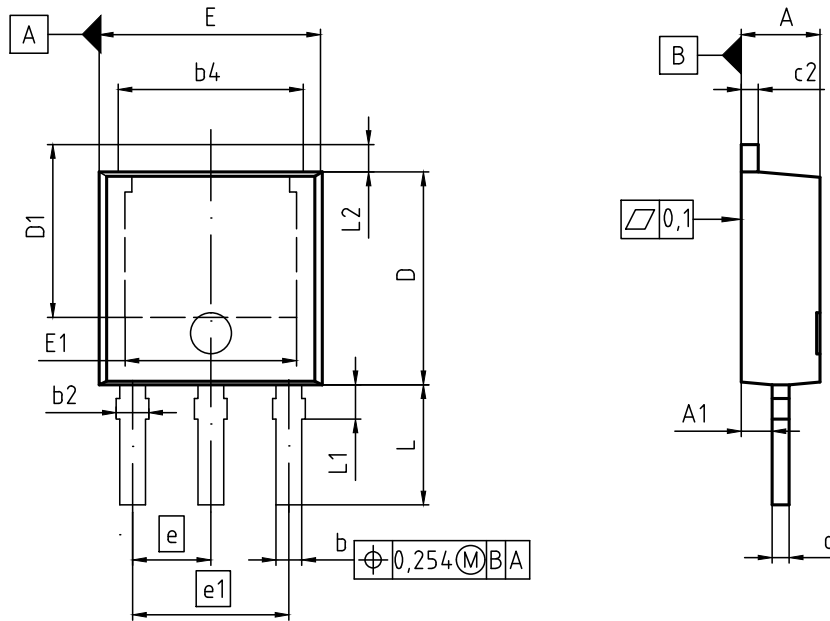

Table 10 Unclamped inductive load



6 Package Outlines



NOTES:

1. STANDARD QUALITY GRADE
2. ALL DIMENSIONS REFER TO JEDEC STANDARD TO-251 DO NOT INCLUDE MOLD FLASH OR PROTRUSIONS.

| DIM | MILLIMETERS | | INCHES | |
|-----|-------------|------|--------|-------|
| | MIN | MAX | MIN | MAX |
| A | 2.20 | 2.40 | 0.087 | 0.094 |
| A1 | 0.90 | 1.14 | 0.035 | 0.045 |
| b | 0.64 | 0.89 | 0.025 | 0.035 |
| b2 | 0.65 | 1.15 | 0.026 | 0.045 |
| b4 | 5.20 | 5.50 | 0.205 | 0.217 |
| c | 0.46 | 0.60 | 0.018 | 0.024 |
| c2 | 0.46 | 0.60 | 0.018 | 0.024 |
| D | 5.98 | 6.22 | 0.235 | 0.245 |
| D1 | 5.00 | 5.60 | 0.197 | 0.220 |
| E | 6.35 | 6.73 | 0.250 | 0.265 |
| E1 | 4.63 | 5.21 | 0.182 | 0.205 |
| e | 2.29 | | 0.090 | |
| e1 | 4.57 | | 0.180 | |
| N | 3 | | 3 | |
| L | 3.30 | 3.60 | 0.130 | 0.142 |
| L1 | 0.85 | 1.25 | 0.033 | 0.049 |
| L2 | 0.88 | 1.28 | 0.035 | 0.050 |

| |
|-----------------------------|
| DOCUMENT NO. Z8B00181052 |
| SCALE |
| EUROPEAN PROJECTION |
| ISSUE DATE 06-04-2016 |
| REVISION 01 |

Figure 1 Outline PG-TO 251-3, dimensions in mm/inches

7 Appendix A

Table 11 Related Links

- **IFX CoolMOS PFD7 Webpage:** www.infineon.com
- **IFX CoolMOS PFD7 application note:** www.infineon.com
- **IFX CoolMOS PFD7 simulation model:** www.infineon.com
- **IFX Design tools:** www.infineon.com

Revision History

IPS60R360PFD7S

Revision: 2019-09-27, Rev. 2.0

Previous Revision

| Revision | Date | Subjects (major changes since last revision) |
|----------|------------|--|
| 2.0 | 2019-09-27 | Release of final version |

Trademarks

All referenced product or service names and trademarks are the property of their respective owners.

We Listen to Your Comments

Any information within this document that you feel is wrong, unclear or missing at all? Your feedback will help us to continuously improve the quality of this document. Please send your proposal (including a reference to this document) to:

erratum@infineon.com

Published by

Infineon Technologies AG
81726 München, Germany
© 2019 Infineon Technologies AG
All Rights Reserved.

Legal Disclaimer

The information given in this document shall in no event be regarded as a guarantee of conditions or characteristics ("Beschaffheitsgarantie").

With respect to any examples, hints or any typical values stated herein and/or any information regarding the application of the product, Infineon Technologies hereby disclaims any and all warranties and liabilities of any kind, including without limitation warranties of non-infringement of intellectual property rights of any third party.

In addition, any information given in this document is subject to customer's compliance with its obligations stated in this document and any applicable legal requirements, norms and standards concerning customer's products and any use of the product of Infineon Technologies in customer's applications.

The data contained in this document is exclusively intended for technically trained staff. It is the responsibility of customer's technical departments to evaluate the suitability of the product for the intended application and the completeness of the product information given in this document with respect to such application.

Information

For further information on technology, delivery terms and conditions and prices please contact your nearest Infineon Technologies Office (www.infineon.com).

Warnings

Due to technical requirements, components may contain dangerous substances. For information on the types in question, please contact the nearest Infineon Technologies Office.

The Infineon Technologies component described in this Data Sheet may be used in life-support devices or systems and/or automotive, aviation and aerospace applications or systems only with the express written approval of Infineon Technologies, if a failure of such components can reasonably be expected to cause the failure of that life-support, automotive, aviation and aerospace device or system or to affect the safety or effectiveness of that device or system. Life support devices or systems are intended to be implanted in the human body or to support and/or maintain and sustain and/or protect human life. If they fail, it is reasonable to assume that the health of the user or other persons may be endangered.

Mouser Electronics

Authorized Distributor

Click to View Pricing, Inventory, Delivery & Lifecycle Information:

[Infineon:](#)

[IPS60R360PFD7SAKMA1](#)