

MOSFET

650V CoolMOS™ CFD7A SJ Power Device

650V CoolMOS™ CFD7A is Infineon's latest generation of market leading automotive qualified high voltage CoolMOS™ MOSFETs. In addition to the well-known attributes of high quality and reliability required by the automotive industry, the new CoolMOS™ CFD7A series provides for an integrated fast body diode and can be used for PFC and resonant switching topologies like the ZVS phase-shift full-bridge and LLC.

Features

- Latest 650V automotive qualified technology with integrated fast body diode on the market featuring ultra low Q_{rr}
- Lowest FOM $R_{DS(on)} * Q_g$ and $R_{DS(on)} * E_{oss}$
- 100% avalanche tested
- Kelvin source contact available
- Best-in-class $R_{DS(on)}$ in SMD and THD packages

Benefits

- Optimized for higher battery voltages up to 475 V thanks to further improved robustness
- Lower switching losses enabling higher switching frequencies
- High quality and reliability
- Advanced controllability due to kelvin source
- Increased package creepage distance
- Increased efficiency in light load and full load conditions

Potential applications

- Suitable for PFC and DC-DC stages for:
- Unidirectional and bidirectional DC-DC converters,
 - On-Board battery Chargers

Product validation

Qualified according to AEC Q101

Please note: The source and sense source pins are not exchangeable. Their exchange might lead to malfunction. For production part approval process (PPAP) release we propose to share application related information during an early design phase to avoid delays in PPAP release. Please contact Infineon sales office.

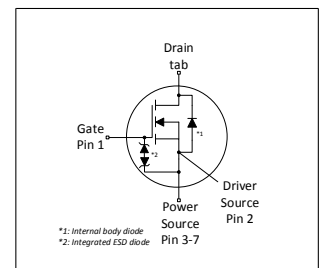
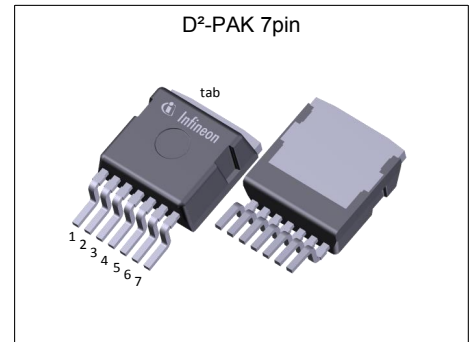

Table 1 Key Performance Parameters

| Parameter | Value | Unit |
|----------------------|-------|------|
| V_{DS} | 650 | V |
| $R_{DS(on),max}$ | 230 | mΩ |
| $Q_{g,typ}$ | 23 | nC |
| $I_{D,pulse}$ | 44 | A |
| $E_{oss} @ 400V$ | 3.0 | μJ |
| Body diode di_F/dt | 1300 | A/μs |

| Type / Ordering Code | Package | Marking | Related Links |
|----------------------|---------------|----------|----------------|
| IPBE65R230CFD7A | PG-TO263-7-11 | 65A230F7 | see Appendix A |

Table of Contents

| | |
|---|----|
| Description | 1 |
| Maximum ratings | 3 |
| Thermal characteristics | 4 |
| Electrical characteristics | 5 |
| Electrical characteristics diagrams | 7 |
| Test Circuits | 11 |
| Package Outlines | 12 |
| Appendix A | 13 |
| Revision History | 14 |
| Trademarks | 14 |
| Disclaimer | 14 |

1 Maximum ratings

at $T_j = 25^\circ\text{C}$, unless otherwise specified

Table 2 Maximum ratings

| Parameter | Symbol | Values | | | Unit | Note / Test Condition |
|--|---------------------|--------|------|---------|------------------|--|
| | | Min. | Typ. | Max. | | |
| Continuous drain current ¹⁾ | I_D | - | - | 11 7 | A | $T_C=25^\circ\text{C}$ $T_C=100^\circ\text{C}$ |
| Pulsed drain current ²⁾ | $I_{D,pulse}$ | - | - | 44 | A | $T_C=25^\circ\text{C}$ |
| Avalanche energy, single pulse | E_{AS} | - | - | 52 | mJ | $I_D=3.0\text{A}$; $V_{DD}=50\text{V}$; see table 10 |
| Avalanche current, single pulse | I_{AS} | - | - | 3.0 | A | - |
| MOSFET dv/dt ruggedness | dv/dt | - | - | 120 | V/ns | $V_{DS}=0\dots400\text{V}$ |
| Gate source voltage (static) | V_{GS} | -20 | - | 20 | V | static; |
| Gate source voltage (dynamic) | $V_{GSK,pulse}$ | -30 | - | 30 | V | $f_{repetition} \leq 100\text{kHz}$, $t_{pulse} \leq 2\text{ns}$ |
| Power dissipation | P_{tot} | - | - | 63 | W | $T_C=25^\circ\text{C}$ |
| Storage temperature | T_{stg} | -55 | - | 150 | $^\circ\text{C}$ | - |
| Operating junction temperature | T_j | -40 | - | 150 | $^\circ\text{C}$ | - |
| Mounting torque | - | - | - | - | Ncm | - |
| Continuous diode forward current | I_S | - | - | 11 | A | $T_C=25^\circ\text{C}$ |
| Diode pulse current ²⁾ | $I_{S,pulse}$ | - | - | 44 | A | $T_C=25^\circ\text{C}$ |
| Reverse diode dv/dt ³⁾ | dv/dt | - | - | 70 | V/ns | $V_{DS}=0\dots400\text{V}$, $I_{SD} \leq 5.2\text{A}$, $T_j=25^\circ\text{C}$ see table 8 |
| Maximum diode commutation speed | di _f /dt | - | - | 1300 | A/ μs | $V_{DS}=0\dots400\text{V}$, $I_{SD} \leq 5.2\text{A}$, $T_j=25^\circ\text{C}$ see table 8 |

¹⁾ Limited by $T_{j,max}$.

²⁾ Pulse width t_p limited by $T_{j,max}$

³⁾ Identical low side and high side switch with identical R_θ

2 Thermal characteristics

Table 3 Thermal characteristics

| Parameter | Symbol | Values | | | Unit | Note / Test Condition |
|---|------------|--------|------|------|------|-----------------------|
| | | Min. | Typ. | Max. | | |
| Thermal resistance, junction - case | R_{thJC} | - | - | 1.99 | °C/W | - |
| Soldering temperature, reflow soldering allowed | T_{sold} | - | - | 260 | °C | reflow MSL1 |

3 Electrical characteristics

at $T_j=25^\circ\text{C}$, unless otherwise specified

Table 4 Static characteristics

| Parameter | Symbol | Values | | | Unit | Note / Test Condition |
|--|---------------|--------|----------------|------------|----------|---|
| | | Min. | Typ. | Max. | | |
| Drain-source breakdown voltage ¹⁾ | $V_{(BR)DSS}$ | 650 | - | - | V | $V_{GS}=0V, I_D=1mA$ |
| Gate threshold voltage ²⁾ | $V_{(GS)th}$ | 3.5 | 4 | 4.5 | V | $V_{DS}=V_{GS}, I_D=0.26mA$ |
| Zero gate voltage drain current | I_{DSS} | - | - | 1 | μA | $V_{DS}=650V, V_{GS}=0V, T_j=25^\circ C$ $V_{DS}=650V, V_{GS}=0V, T_j=150^\circ C$ |
| Gate-source leakage current incl. protection diode | I_{GSS} | - | - | 1 | μA | $V_{GS}=20V, V_{DS}=0V$ |
| Drain-source on-state resistance | $R_{DS(on)}$ | - | 0.196 0.439 | 0.230 - | Ω | $V_{GS}=10V, I_D=5.2A, T_j=25^\circ C$ $V_{GS}=10V, I_D=5.2A, T_j=150^\circ C$ |
| Gate resistance | R_G | - | 11.0 | - | Ω | $f=250kHz, \text{open drain}$ |

Table 5 Dynamic characteristics

External parasitic elements (PCB layout) influence switching behavior significantly. Stray inductances and coupling capacitances must be minimized. For layout recommendations please use provided application notes or contact Infineon sales office.

| Parameter | Symbol | Values | | | Unit | Note / Test Condition |
|--|--------------|--------|------|------|------|---|
| | | Min. | Typ. | Max. | | |
| Input capacitance | C_{iss} | - | 1044 | - | pF | $V_{GS}=0V, V_{DS}=400V, f=250kHz$ |
| Output capacitance | C_{oss} | - | 17 | - | pF | $V_{GS}=0V, V_{DS}=400V, f=250kHz$ |
| Effective output capacitance, energy related ³⁾ | $C_{o(er)}$ | - | 38 | - | pF | $V_{GS}=0V, V_{DS}=0...400V$ |
| Effective output capacitance, time related ⁴⁾ | $C_{o(tr)}$ | - | 394 | - | pF | $I_D=\text{constant}, V_{GS}=0V, V_{DS}=0...400V$ |
| Turn-on delay time | $t_{d(on)}$ | - | 13 | - | ns | $V_{DD}=400V, V_{GS}=13V, I_D=5.2A, R_G=10.2\Omega; \text{see table 9}$ |
| Rise time | t_r | - | 3 | - | ns | $V_{DD}=400V, V_{GS}=13V, I_D=5.2A, R_G=10.2\Omega; \text{see table 9}$ |
| Turn-off delay time | $t_{d(off)}$ | - | 56 | - | ns | $V_{DD}=400V, V_{GS}=13V, I_D=5.2A, R_G=10.2\Omega; \text{see table 9}$ |
| Fall time | t_f | - | 5 | - | ns | $V_{DD}=400V, V_{GS}=13V, I_D=5.2A, R_G=10.2\Omega; \text{see table 9}$ |

¹⁾ For applications with applied blocking voltage > 475 V, we recommend to evaluate the impact of the cosmic radiation effect in early design phase. For assessment, please contact local Infineon sales office.

²⁾ We do not recommend using the CoolMOS mentioned in this datasheet to operate in "linear mode". For assessment of potential "linear mode", please contact Infineon sales office.

³⁾ $C_{o(er)}$ is a fixed capacitance that gives the same stored energy as C_{oss} while V_{DS} is rising from 0 to 400V

⁴⁾ $C_{o(tr)}$ is a fixed capacitance that gives the same charging time as C_{oss} while V_{DS} is rising from 0 to 400V

Table 6 Gate charge characteristics

| Parameter | Symbol | Values | | | Unit | Note / Test Condition |
|-----------------------|---------------|--------|------|------|------|--|
| | | Min. | Typ. | Max. | | |
| Gate to source charge | Q_{gs} | - | 6 | - | nC | $V_{DD}=400V, I_D=5.2A, V_{GS}=0$ to 10V |
| Gate to drain charge | Q_{gd} | - | 7 | - | nC | $V_{DD}=400V, I_D=5.2A, V_{GS}=0$ to 10V |
| Gate charge total | Q_g | - | 23 | - | nC | $V_{DD}=400V, I_D=5.2A, V_{GS}=0$ to 10V |
| Gate plateau voltage | $V_{plateau}$ | - | 5.8 | - | V | $V_{DD}=400V, I_D=5.2A, V_{GS}=0$ to 10V |

Table 7 Reverse diode characteristics

| Parameter | Symbol | Values | | | Unit | Note / Test Condition |
|-------------------------------|-----------|--------|------|------|---------|---|
| | | Min. | Typ. | Max. | | |
| Diode forward voltage | V_{SD} | - | 1.1 | - | V | $V_{GS}=0V, I_F=5.2A, T_j=25^\circ C$ |
| Reverse recovery time | t_{rr} | - | 91 | - | ns | $V_R=400V, I_F=5.2A, di_F/dt=100A/\mu s$; see table 8 |
| Reverse recovery charge | Q_{rr} | - | 0.4 | - | μC | $V_R=400V, I_F=5.2A, di_F/dt=100A/\mu s$; see table 8 |
| Peak reverse recovery current | I_{rrm} | - | 7.9 | - | A | $V_R=400V, I_F=5.2A, di_F/dt=100A/\mu s$; see table 8 |

4 Electrical characteristics diagrams

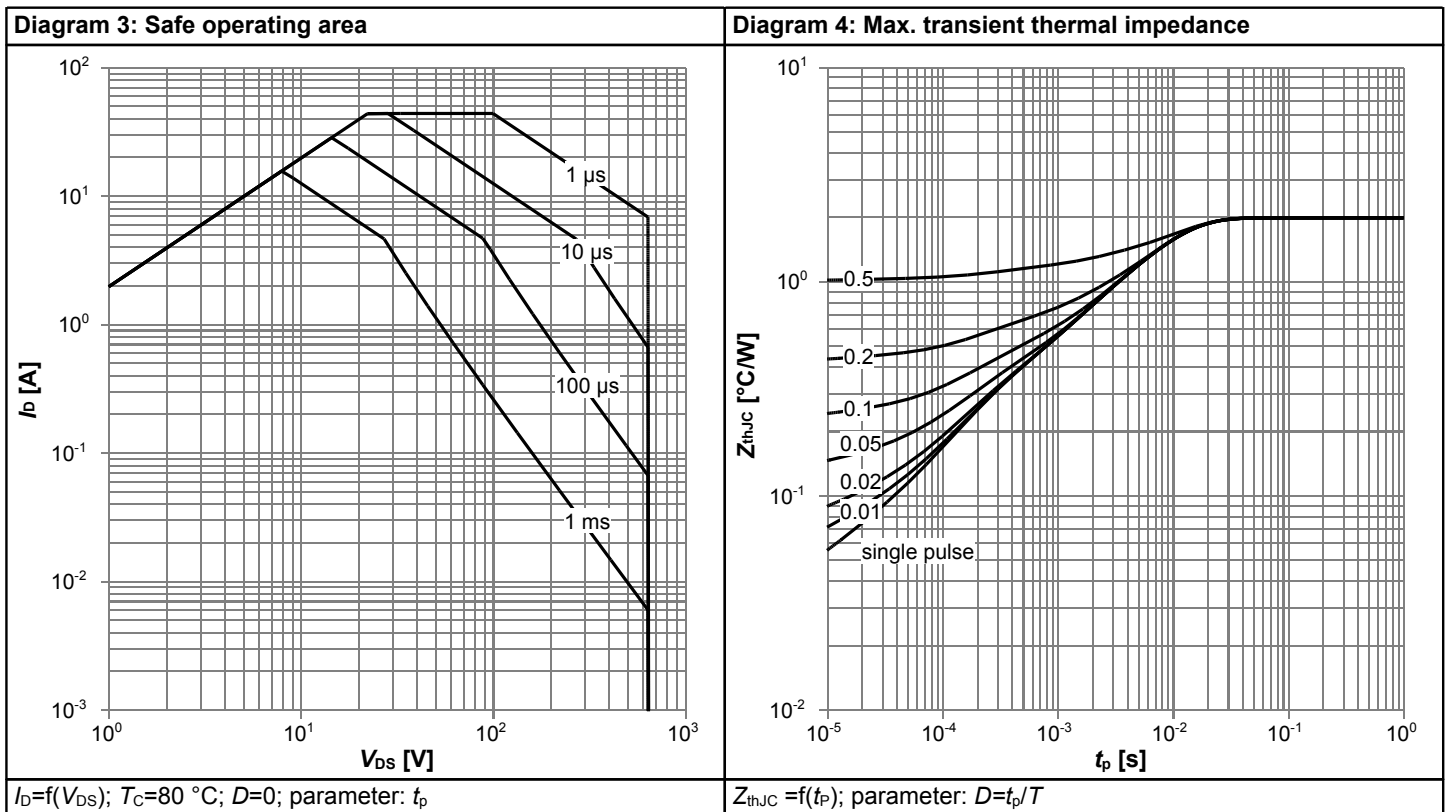
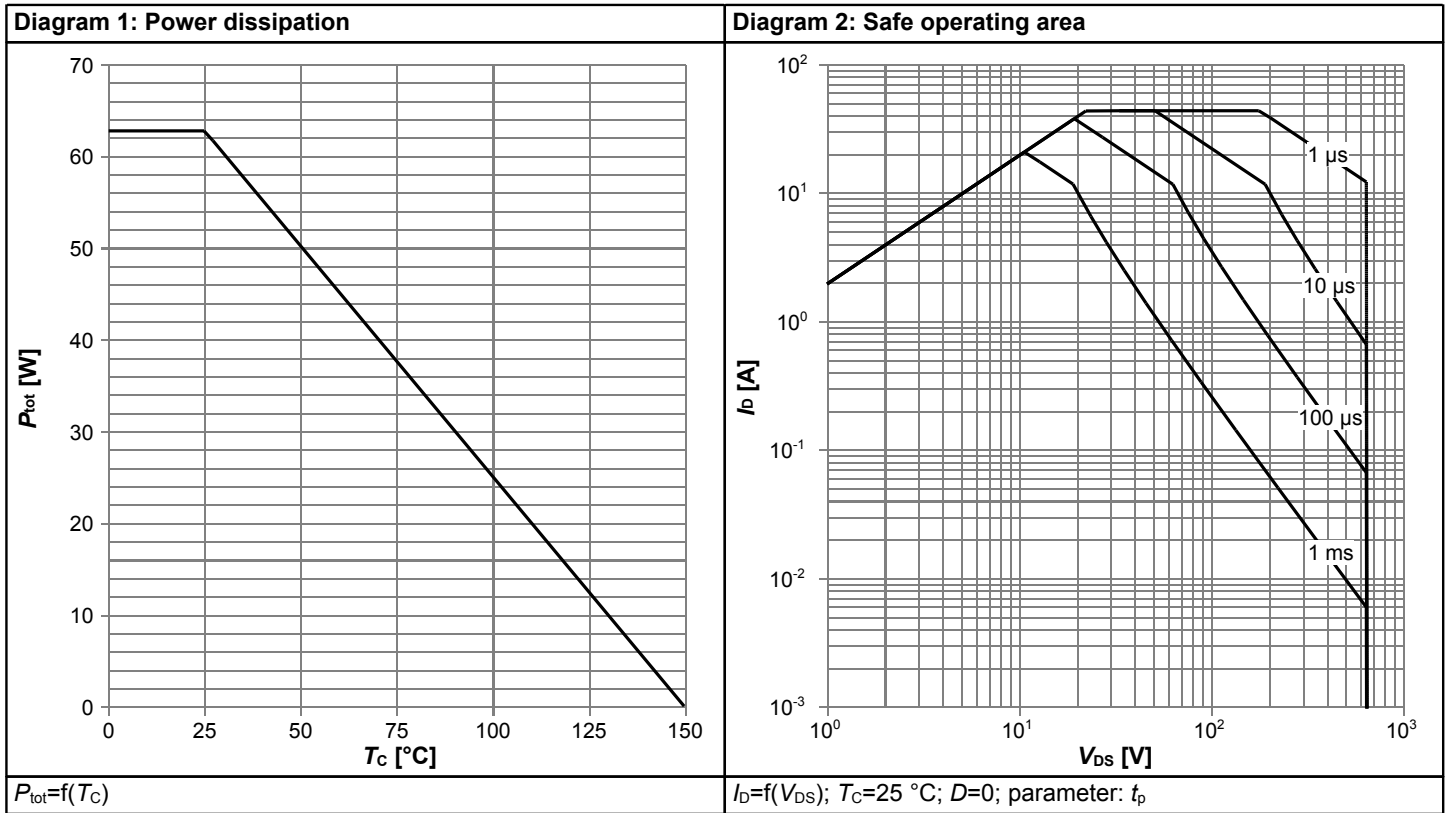
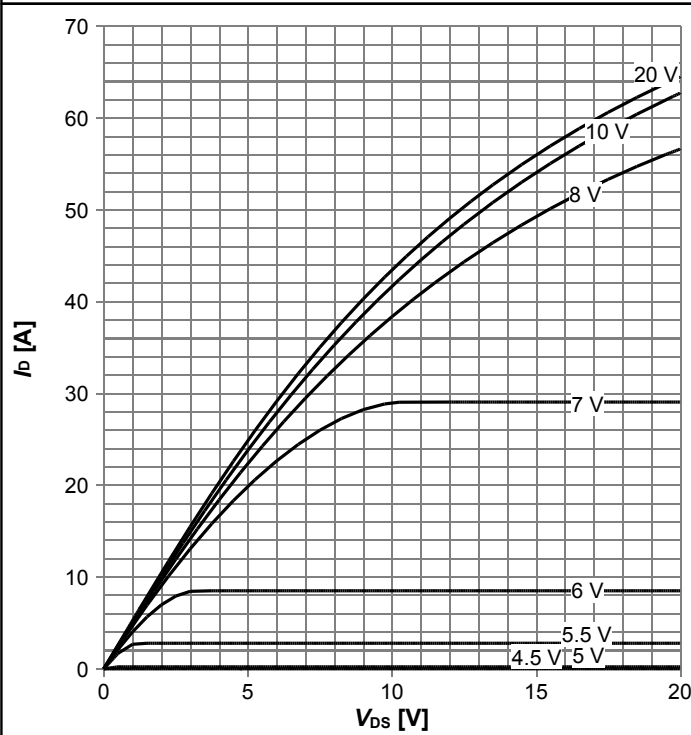
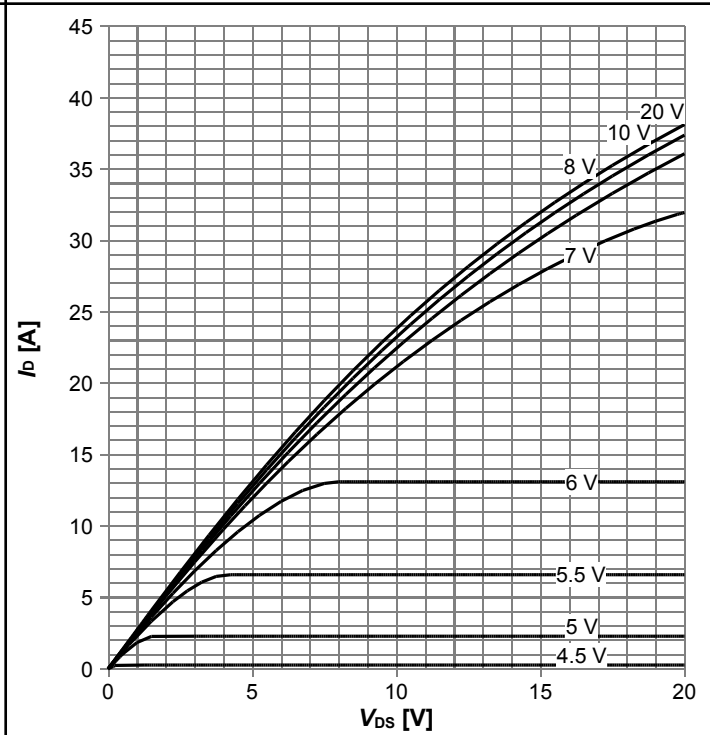

Diagram 5: Typ. output characteristics



$I_D = f(V_{DS})$; $T_j = 25\text{ °C}$; parameter: V_{GS}

Diagram 6: Typ. output characteristics



$I_D = f(V_{DS})$; $T_j = 125\text{ °C}$; parameter: V_{GS}

Diagram 7: Typ. drain-source on-state resistance

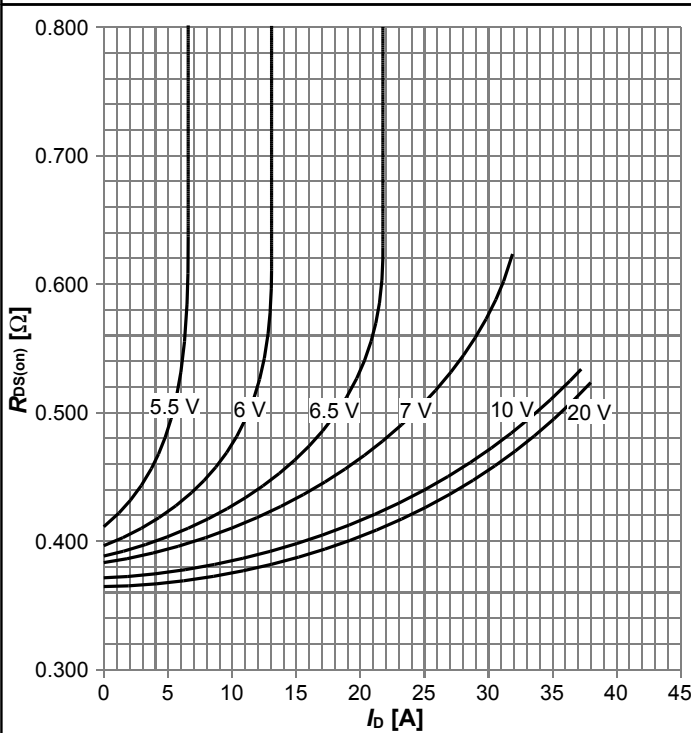

$R_{DS(on)} = f(I_D)$; $T_j = 125\text{ °C}$; parameter: V_{GS}

Diagram 8: Drain-source on-state resistance

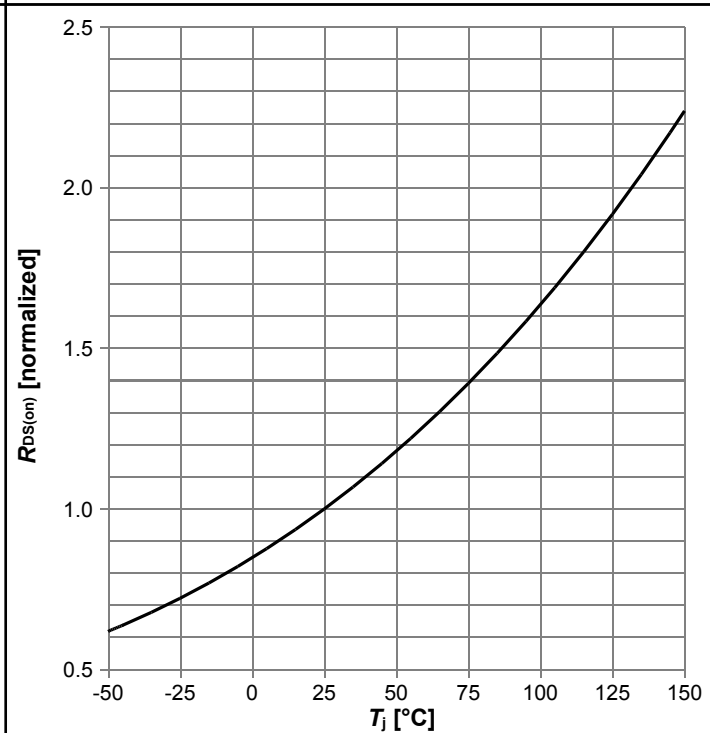

$R_{DS(on)} = f(T_j)$; $I_D = 5.2\text{ A}$; $V_{GS} = 10\text{ V}$

Diagram 9: Typ. transfer characteristics

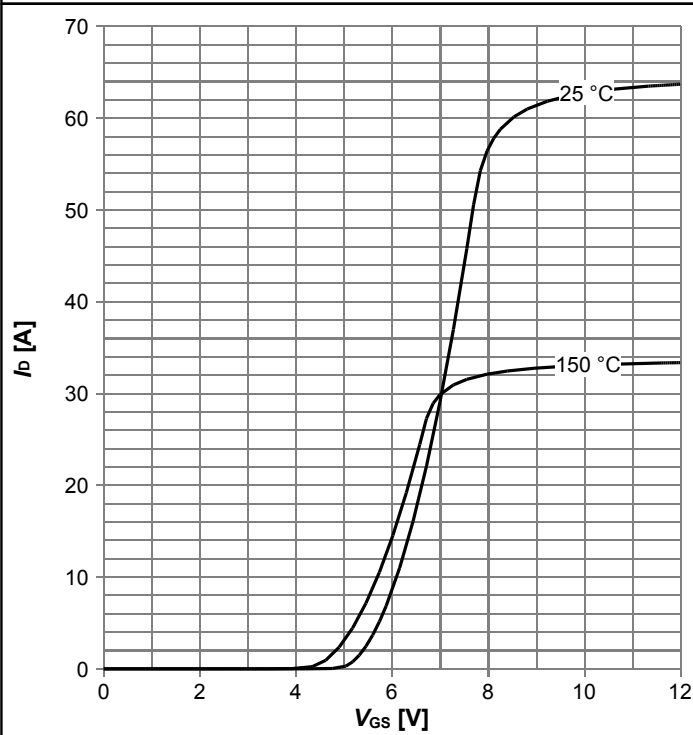

$I_D=f(V_{GS}); V_{DS}=20V$; parameter: T_j

Diagram 10: Typ. gate charge

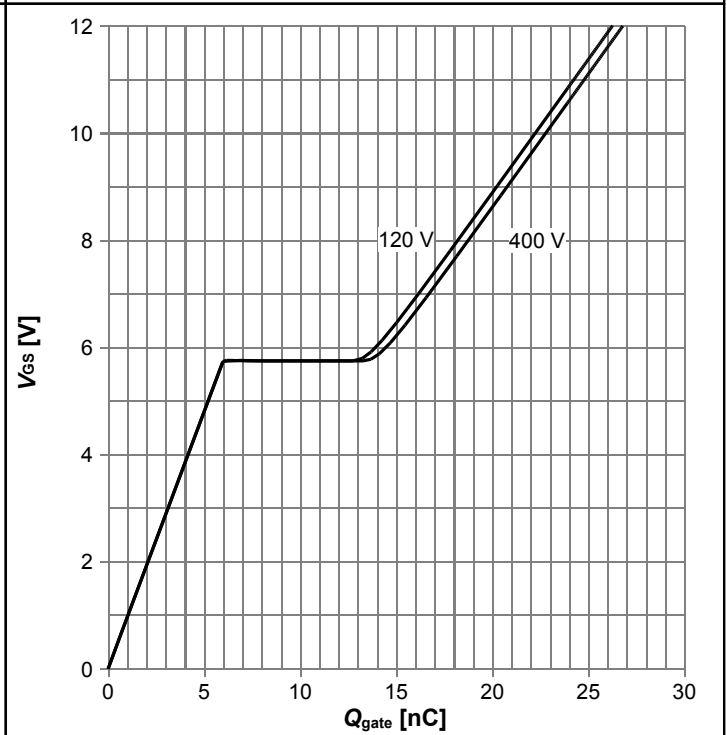

$V_{GS}=f(Q_{gate}); I_D=5.2 A$ pulsed; parameter: V_{DD}

Diagram 11: Forward characteristics of reverse diode

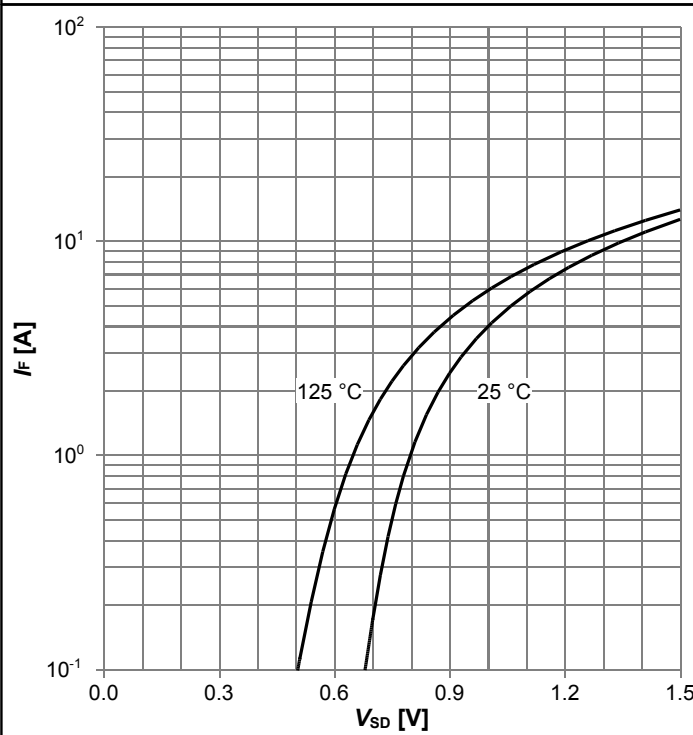

$I_F=f(V_{SD})$; parameter: T_j

Diagram 12: Avalanche energy

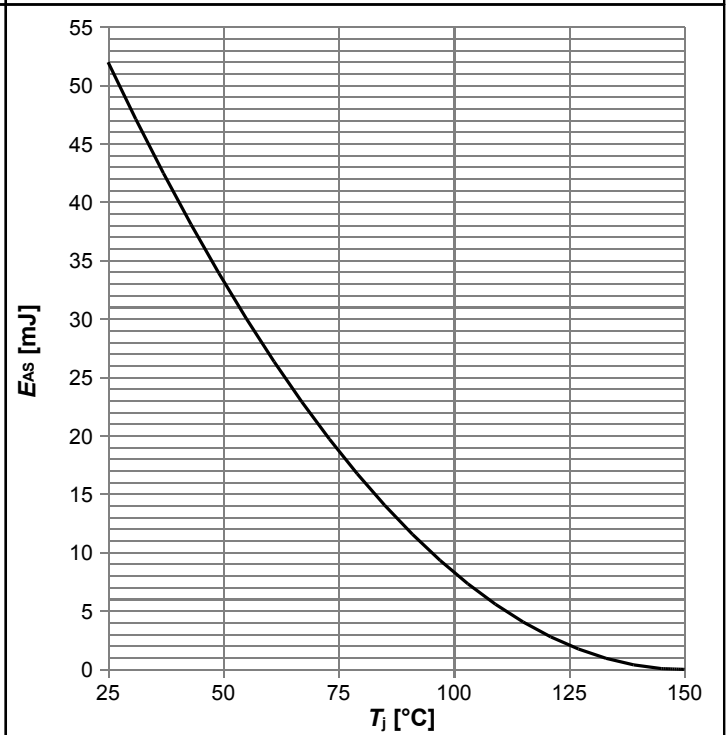

$E_{AS}=f(T_j); I_D=3.0 A; V_{DD}=50 V$

Diagram 13: Drain-source breakdown voltage

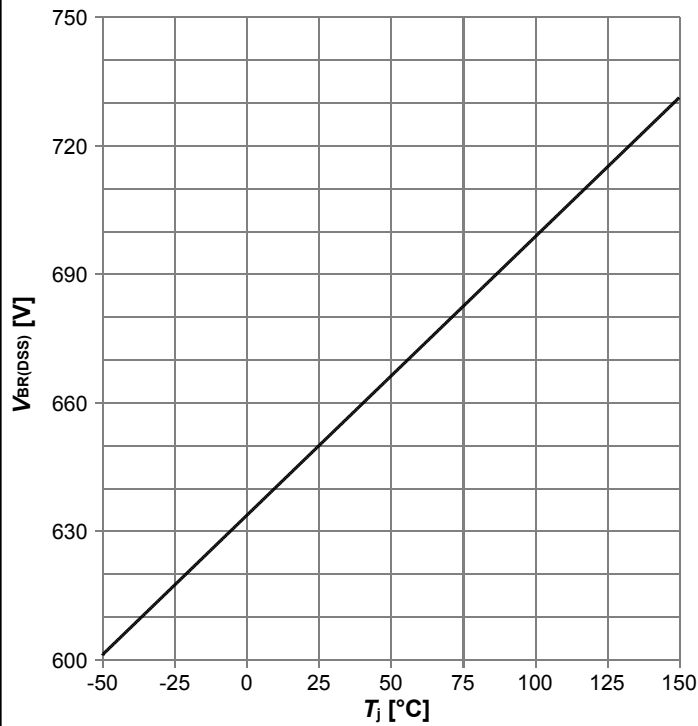

$V_{BR(DSS)}=f(T_j); I_D=1 \text{ mA}$

Diagram 14: Typ. capacitances

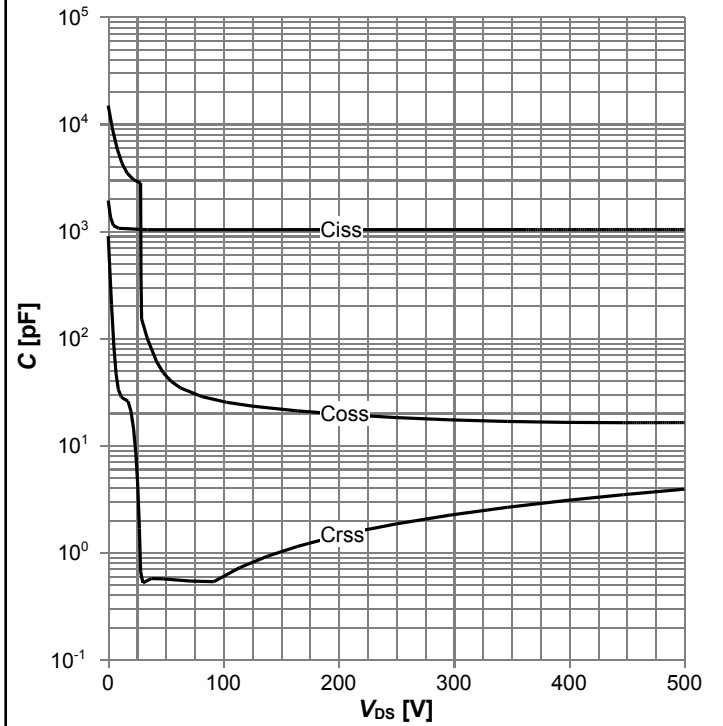

$C=f(V_{DS}); V_{GS}=0 \text{ V}; f=250 \text{ kHz}$

Diagram 15: Typ. Coss stored energy

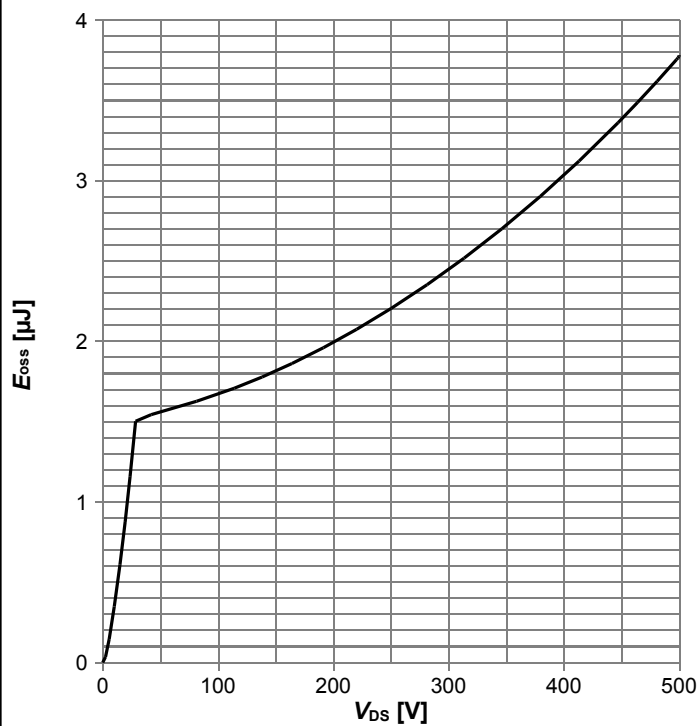

$E_{oss}=f(V_{DS})$

5 Test Circuits

Table 8 Diode characteristics



Table 9 Switching times (ss)



Table 10 Unclamped inductive load (ss)



6 Package Outlines

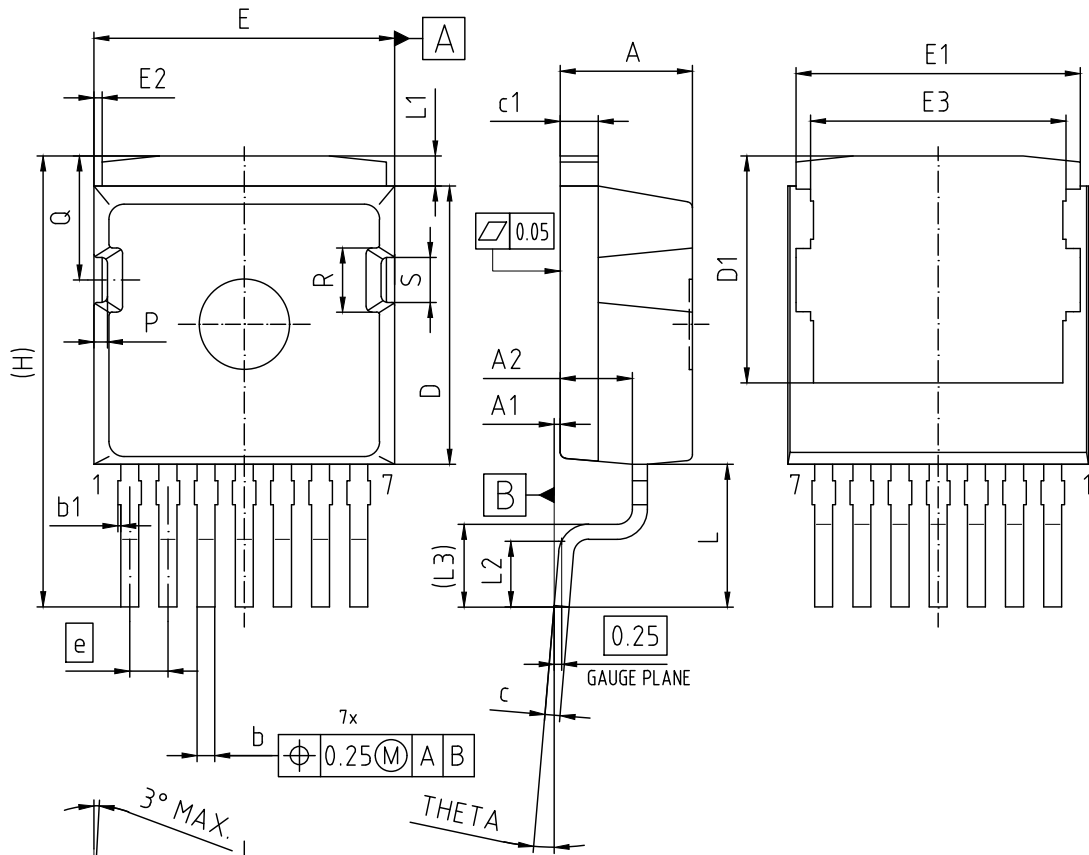

ALL METAL SURFACES TIN PLATED EXCEPT AREA OF CUT

| DIMENSIONS | MILLIMETERS | |
|------------|-------------|-------|
| | MIN. | MAX. |
| A | 4.30 | 4.50 |
| A1 | 0.00 | 0.20 |
| A2 | 2.30 | 2.50 |
| b | 0.50 | 0.70 |
| b1 | 0.00 | 0.15 |
| c | 0.40 | 0.60 |
| c1 | 1.17 | 1.37 |
| D | 9.05 | 9.45 |
| D1 | 7.30 | 7.50 |
| E | 9.80 | 10.20 |
| E1 | 9.36 | 9.56 |
| E2 | 0.00 | 0.30 |
| E3 | 8.40 | 8.60 |
| e | 1.27 | |
| H | 15.00 | |
| L | 4.20 | 5.20 |
| L1 | 0.70 | 1.30 |
| L2 | 1.70 | 2.30 |
| L3 | 2.70 | |
| P | 0.35 | 0.55 |
| Q | 4.02 | 4.22 |
| R | 2.03 | 2.23 |
| S | 1.40 | 1.60 |
| THETA | 0.00° | 8.00° |

| |
|---------------------------------------|
| DOCUMENT NO. Z8B00189665 |
| REVISION 01 |
| SCALE 5:1 0 1 2 3 4 5mm |
| EUROPEAN PROJECTION |
| ISSUE DATE 20.09.2018 |

Figure 1 Outline PG-T0263-7-11, dimensions in mm

7 Appendix A

Table 11 Related Links

- IFX CoolMOS CFD7A Webpage: www.infineon.com
- IFX CoolMOS CFD7A application note: www.infineon.com
- IFX CoolMOS CFD7A simulation model: www.infineon.com
- IFX Design tools: www.infineon.com

Revision History

IPBE65R230CFD7A

Revision: 2020-04-02, Rev. 2.1

Previous Revision

| Revision | Date | Subjects (major changes since last revision) |
|----------|------------|---|
| 2.0 | 2020-03-04 | Release of final version |
| 2.1 | 2020-04-02 | Updated marketing text and drain-source breakdown voltage footnote. |

Trademarks

All referenced product or service names and trademarks are the property of their respective owners.

Disclaimer

We Listen to Your Comments

Any information within this document that you feel is wrong, unclear or missing at all? Your feedback will help us to continuously improve the quality of this document. Please send your proposal (including a reference to this document) to:

erratum@infineon.com

Published by

Infineon Technologies AG

81726 München, Germany

© 2020 Infineon Technologies AG

All Rights Reserved.

Legal Disclaimer

The information given in this document shall in no event be regarded as a guarantee of conditions or characteristics ("Beschaffheitsgarantie").

With respect to any examples, hints or any typical values stated herein and/or any information regarding the application of the product, Infineon Technologies hereby disclaims any and all warranties and liabilities of any kind, including without limitation warranties of non-infringement of intellectual property rights of any third party.

In addition, any information given in this document is subject to customer's compliance with its obligations stated in this document and any applicable legal requirements, norms and standards concerning customer's products and any use of the product of Infineon Technologies in customer's applications.

The data contained in this document is exclusively intended for technically trained staff. It is the responsibility of customer's technical departments to evaluate the suitability of the product for the intended application and the completeness of the product information given in this document with respect to such application.

Information

For further information on technology, delivery terms and conditions and prices please contact your nearest Infineon Technologies Office (www.infineon.com).

Warnings

Due to technical requirements components may contain dangerous substances. For information on the types in question please contact your nearest Infineon Technologies Office.

Infineon Technologies Components may only be used in life-support devices or systems with the express written approval of Infineon Technologies, if a failure of such components can reasonably be expected to cause the failure of that life-support device or system, or to affect the safety or effectiveness of that device or system. Life support devices or systems are intended to be implanted in the human body, or to support and/or maintain and sustain and/or protect human life.

If they fail, it is reasonable to assume that the health of the user or other persons may be endangered.

Mouser Electronics

Authorized Distributor

Click to View Pricing, Inventory, Delivery & Lifecycle Information:

[Infineon:](#)

[IPBE65R230CFD7AATMA1](#)