

Control Integrated POver System (CIPOS™)

IFCM20U65GD

Datasheet

Table of contents

Table of contents	2
CIPOS™ Control Integrated Power System	3
Features	3
Target Applications.....	3
Description	3
System Configuration	3
Pin Configuration.....	4
Internal Electrical Schematic.....	4
Pin Assignment	5
Pin Description	5
LIN(X, Y, Z) (IGBT control pins, Pin 7, 8, 9)	5
VFO (Fault-output, Pin 12)	6
NTC (Thermistor, Pin 15)	6
ITRIP (Over current detection function, Pin 13).....	6
VDD, VSS (Control supply and reference, Pin 11, 14)	6
NX, NY, NZ (IGBT emitter, Pin 17, 19, 21)	6
X, Y, Z (IGBT collector, Pin 18, 20, 22)	6
P (Positive output voltage, Pin 23)	6
Absolute Maximum Ratings	7
Module Section	7
Power Section	7
Control Section	8
Recommended Operation Conditions	8
Static Parameters	9
Dynamic Parameters	10
Thermistor	11
Mechanical Characteristics and Ratings	11
Electrical characteristic	14
Package Outline.....	15
Revision history	16

CIPOS™

Control Integrated Power System

*Dual In-Line Intelligent Power Module
Three Phase Interleaved PFC 650V / 20A*

Features

Dual In-Line molded module

- TRENCHSTOP™ 5
- Rapid switching emitter controlled diode
- Rugged SOI gate driver technology with stability against transient
- Over current shutdown
- Under-voltage lockout
- All of 3 switches turn off during protection
- Temperature monitor
- Emitter pins accessible for all phase current monitoring (open emitter)
- Lead-free terminal plating; RoHS compliant
- Very low thermal resistance due to DCB

Target Applications

- 3-Phase Interleaved PFC

Description

The CIPOS™ module family offers the chance for integrating various power and control components to increase reliability, optimize PCB size and system costs.

It is designed to enhance the system efficiency by improvement of power factor. The package concept is specially adapted to power applications, which need good thermal conduction and electrical isolation, but also EMI-save control and overload protection.

TRENCHSTOP™ 5 are combined with an optimized SOI gate driver for excellent electrical performance.

System Configuration

- 3-Phase Interleaved PFC with TRENCHSTOP™ 5 and Rapid switching emitter controlled diode
- SOI gate driver
- Thermistor
- Pin-to-heatsink clearance distance typ. 1.6mm

Pin Configuration

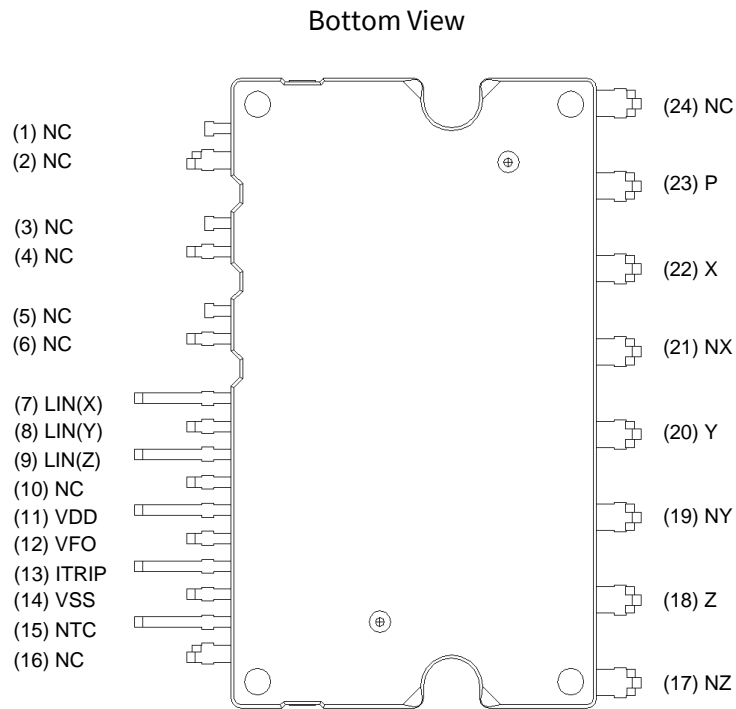

Figure 1 Pin configuration

Internal Electrical Schematic

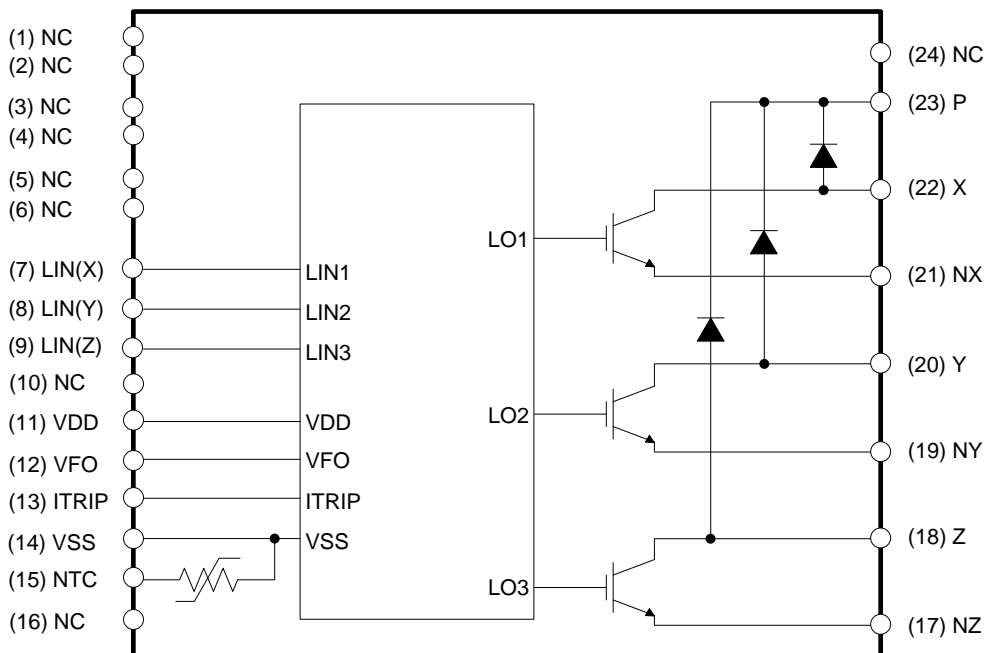

Figure 2 Internal schematic

Pin Assignment

Pin Number	Pin Name	Pin Description
1	NC	No Connection
2	NC	No Connection
3	NC	No Connection
4	NC	No Connection
5	NC	No Connection
6	NC	No Connection
7	LIN(X)	X phase IGBT gate driver input
8	LIN(Y)	Y phase IGBT gate driver input
9	LIN(Z)	Z phase IGBT gate driver input
10	NC	No Connection
11	VDD	Control supply
12	VFO	Fault output
13	ITRIP	Over current shutdown input
14	VSS	Control negative supply
15	NTC	Thermistor
16	NC	No Connection
17	NZ	Z phase IGBT emitter
18	Z	Z phase IGBT collector
19	NY	Y phase IGBT emitter
20	Y	Y phase IGBT collector
21	NX	X phase IGBT emitter
22	X	X phase IGBT collector
23	P	Positive output voltage
24	NC	No Connection

Pin Description

LIN(X, Y, Z) (IGBT control pins, Pin 7, 8, 9)

These pins are positive logic and they are responsible for the control of the integrated IGBT. The Schmitt-trigger input thresholds of them are such to guarantee LSTTL and CMOS compatibility down to 3.3V controller outputs. Pull-down resistor of about 5kΩ is internally provided to pre-bias inputs during supply start-up and a zener clamp is provided for pin protection purposes. Input Schmitt-trigger and noise filter provide beneficial noise rejection to short input pulses.

The noise filter suppresses control pulses which are below the filter time t_{FILIN} . The filter acts according to Figure 4.

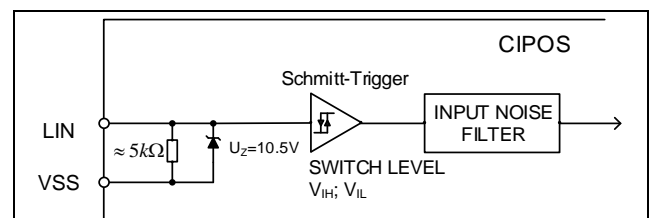

Figure 3 Input pin structure

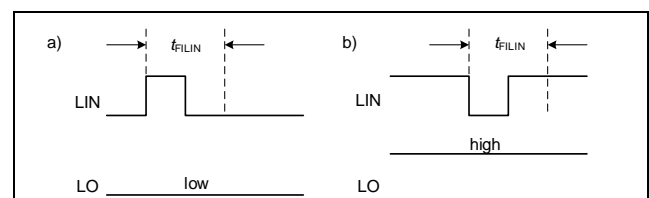

Figure 4 Input filter timing diagram

It is recommended for proper work of this product not to provide input pulse-width lower than 1µs.

VFO (Fault-output, Pin 12)

The VFO pin indicates a module failure in case of under voltage at pin VDD or in case of triggered over current detection at ITRIP.

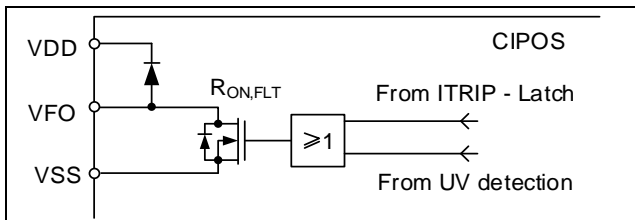

Figure 5 Internal circuit at pin VFO

NTC (Thermistor, Pin 15)

The NTC pin provides direct access to thermistor, which is referenced to VSS. An external pull-up resistor connected to +5V ensures that the resulting voltage can be directly connected to the microcontroller.

ITRIP (Over current detection function, Pin 13)

CIPOS™ provides an over current detection function by connecting the ITRIP input with the IGBT collector current feedback. The ITRIP comparator threshold (typ. 0.47V) is referenced to VSS ground. An input noise filter (typ.: $t_{ITRIPMIN} = 530ns$) prevents the driver to detect false over-current events.

Over current detection generates a shutdown of all outputs of the gate driver after the shutdown propagation delay of typically 1000ns.

VDD, VSS (Control supply and reference, Pin 11, 14)

VDD is the control supply and it provides power both to input logic and to output power stage. Input logic is referenced to VSS ground.

The under-voltage circuit enables the device to operate at power on when a supply voltage of at least a typical voltage of $VDD_{UV+} = 12.1V$ is present.

The IC shuts down all the gate drivers power outputs, when the VDD supply voltage is below $VDD_{UV-} = 10.4V$. This prevents the external power switches from critically low gate voltage levels during on-state and therefore from excessive power dissipation.

NX, NY, NZ (IGBT emitter, Pin 17, 19, 21)

The IGBT emitters are available for current measurements of each phase. It is recommended to keep the connection to pin VSS as short as possible in order to avoid unnecessary inductive voltage drops.

X, Y, Z (IGBT collector, Pin 18, 20, 22)

These pins are IGBT collector. It is mandatory to connect anti-parallel diode between IGBT collector and emitter.

P (Positive output voltage, Pin 23)

The diode cathodes are connected to the output voltage. It is noted that the voltage does not exceed 450 V.

Absolute Maximum Ratings

($V_{DD} = 15V$ and $T_j = 25^\circ C$, if not stated otherwise)

Module Section

Description	Condition	Symbol	Value		Unit
			min	max	
Storage temperature range		T_{stg}	-40	125	$^\circ C$
Isolation test voltage	RMS, $f=60Hz$, $t=1min$	V_{ISOL}	2000	-	V
Operating case temperature range	Refer to Figure 6	T_C	-40	125	$^\circ C$

Power Section

Description	Condition	Symbol	Value		Unit
			min	max	
DC link output voltage of P-N	Applied between P-N	V_{PN}	-	450	V
DC link output voltage (surge) of P-N	Applied between P-N	$V_{PN(surge)}$	-	500	V
Max. blocking voltage	$I_C = 250\mu A$	V_{CES}	650	-	V
Repetitive peak reverse voltage	$I_R = 250\mu A$	V_{RRM}	650	-	V
Input RMS current of each phase	$T_J \leq 150^\circ C$, $T_C = 25^\circ C$ $T_C = 80^\circ C$	I_i	-	20 15	A
Maximum peak input current of each phase	$T_J \leq 150^\circ C$, $T_C = 25^\circ C$ less than 1ms, non-repetitive	$I_{i(peak)}$	-	60	A
Power dissipation of each IGBT		P_{tot}	-	52.3	W
Operating junction temperature range		T_J	-40	150	$^\circ C$
Single IGBT thermal resistance, junction-case		R_{thJC}	-	2.39	K/W
Single diode thermal resistance, junction-case		R_{thJCD}	-	2.77	K/W

Control Section

Description	Condition	Symbol	Value		Unit
			min	max	
Module supply voltage		V_{DD}	-1	20	V
Input voltage	LIN, ITRIP	V_{IN} V_{ITRIP}	-1 -1	10	V
Switching frequency		f_{PWM}	-	60	kHz

Recommended Operation Conditions

All voltages are absolute voltages referenced to V_{SS} -potential unless otherwise specified.

Description	Symbol	Value			Unit
		min	typ	max	
DC link output voltage of P-N	V_{PN}	0	-	450	V
Control supply voltage	V_{DD}	13.5	15	16.5	V
Control supply variation	ΔV_{DD}	-1	-	1	V/ μ s
Logic input voltages LIN, ITRIP	V_{IN} V_{ITRIP}	0 0	-	5 5	V
Between V_{SS} - N (including surge)	V_{SS}	-5	-	5	V



Figure 6 T_c measurement point¹

¹Any measurement except for the specified point in figure 6 is not relevant for the temperature verification and brings wrong or different information.

Static Parameters

($V_{DD} = 15V$ and $T_j = 25^\circ C$, if not stated otherwise)

Description	Condition	Symbol	Value			Unit
			min	typ	max	
Collector-Emitter saturation voltage	$I_C = 15A$ $T_J = 25^\circ C$ $150^\circ C$	$V_{CE(sat)}$	- -	1.7 1.9	2.3 -	V
Diode forward voltage	$I_F = 15A$ $T_J = 25^\circ C$ $150^\circ C$	V_F	- -	1.4 1.3	1.85 -	V
Collector-Emitter leakage current	$V_{CE} = 650V$	I_{CES}	-	-	1	mA
Diode reverse leakage current	$V_R = 650V$	I_R	-	-	1	mA
Logic "1" input voltage (LIN)		V_{IH}	-	2.1	2.5	V
Logic "0" input voltage (LIN)		V_{IL}	0.7	0.9	-	V
ITRIP positive going threshold		$V_{IT,TH+}$	400	470	540	mV
ITRIP input hysteresis		$V_{IT,HYS}$	40	70	-	mV
VDD supply under voltage positive going threshold		V_{DDUV+}	10.8	12.1	13.0	V
VDD supply under voltage negative going threshold		V_{DDUV-}	9.5	10.4	11.2	V
VDD supply under voltage lockout hysteresis		V_{DDUVH}	1.0	1.7	-	V
Quiescent VDD supply current	$V_{IN} = 0V$	I_{QDD}	-	370	900	μA
Input bias current	$V_{IN} = 5V$	I_{IN+}	-	1	1.5	mA
Input bias current	$V_{IN} = 0V$	I_{IN-}	-	2	-	μA
ITRIP input bias current	$V_{ITRIP} = 5V$	I_{ITRIP+}	-	65	150	μA
VFO input bias current	$VFO = 5V, V_{ITRIP} = 0V$	I_{FO}	-	2	-	nA
VFO output voltage	$I_{FO} = 10mA, V_{ITRIP} = 1V$	V_{FO}	-	0.5	-	V

Dynamic Parameters

($V_{DD} = 15V$ and $T_j = 25^\circ C$, if not stated otherwise)

Description	Condition	Symbol	Value			Unit
			min	typ	max	
Turn-on propagation delay time	$V_{LIN} = 5V,$ $I_C = 15A,$ $V_{DC} = 400V$	t_{on}	-	585	-	ns
Turn-on rise time		t_r	-	20	-	ns
Turn-on switching time		$t_{c(on)}$	-	105	-	ns
Reverse recovery time		t_{rr}	-	100	-	ns
Turn-off propagation delay time	$V_{LIN} = 0V,$ $I_C = 15A,$ $V_{DC} = 400V$	t_{off}	-	630	-	ns
Turn-off fall time		t_f	-	10	-	ns
Turn-off switching time		$t_{c(off)}$	-	20	-	ns
Input filter time ITRIP	$V_{ITRIP} = 1V$	$t_{ITRIPmin}$	-	530	-	ns
Input filter time at LIN for turn on and off	$V_{LIN} = 0V \& 5V$	t_{FILIN}	-	290	-	ns
Fault clear time after ITRIP-fault	$V_{ITRIP} = 1V$	t_{FLTCLR}	40	-	-	μs
IGBT turn-on energy (includes reverse recovery of diode)	$V_{DC} = 400V, I_C = 15A$ $T_J = 25^\circ C$ $150^\circ C$	E_{on}	-	440	-	μJ
			-	550	-	
IGBT turn-off energy	$V_{DC} = 400V, I_C = 15A$ $T_J = 25^\circ C$ $150^\circ C$	E_{off}	-	35	-	μJ
			-	65	-	
Diode recovery energy	$V_{DC} = 400V, I_C = 15A$ $T_J = 25^\circ C$ $150^\circ C$	E_{rec}	-	75	-	μJ
			-	145	-	

Thermistor

Description	Condition	Symbol	Value			Unit
			min	typ	max	
Resistor	$T_{NTC} = 25^{\circ}\text{C}$	R_{NTC}	-	85	-	k Ω
B-constant of NTC (Negative Temperature Coefficient)		B(25/100)	-	4092	-	K

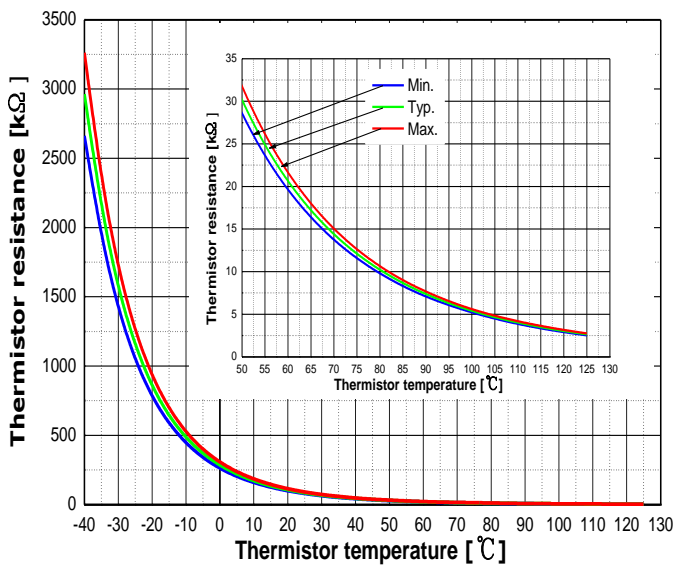

T [°C]	Rmin. [k Ω]	Rtyp. [k Ω]	Rmax. [k Ω]
50	28.400	29.972	31.545
60	19.517	20.515	21.514
70	13.670	14.315	14.960
80	9.745	10.169	10.593
90	7.062	7.345	7.628
100	5.199	5.388	5.576
110	3.856	4.009	4.163
120	2.900	3.024	3.149
125	2.527	2.639	2.751

Figure 7 Thermistor resistance – temperature curve and table

(For more information, please refer to the application note ‘AN CIPOS™-Mini 1 Technical description’)

Mechanical Characteristics and Ratings

Description	Condition	Value			Unit
		min	typ	max	
Mounting torque	M3 screw and washer	0.49	-	0.78	Nm
Flatness	Refer to Figure 8	-50	-	100	μm
Weight		-	6.58	-	g

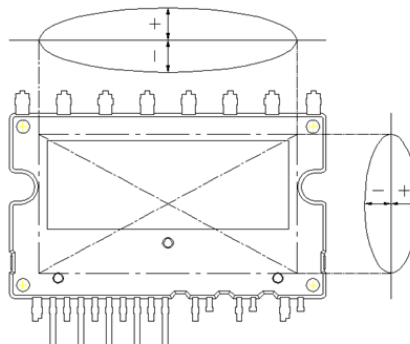

Figure 8 Flatness measurement position

Circuit of a Typical Application

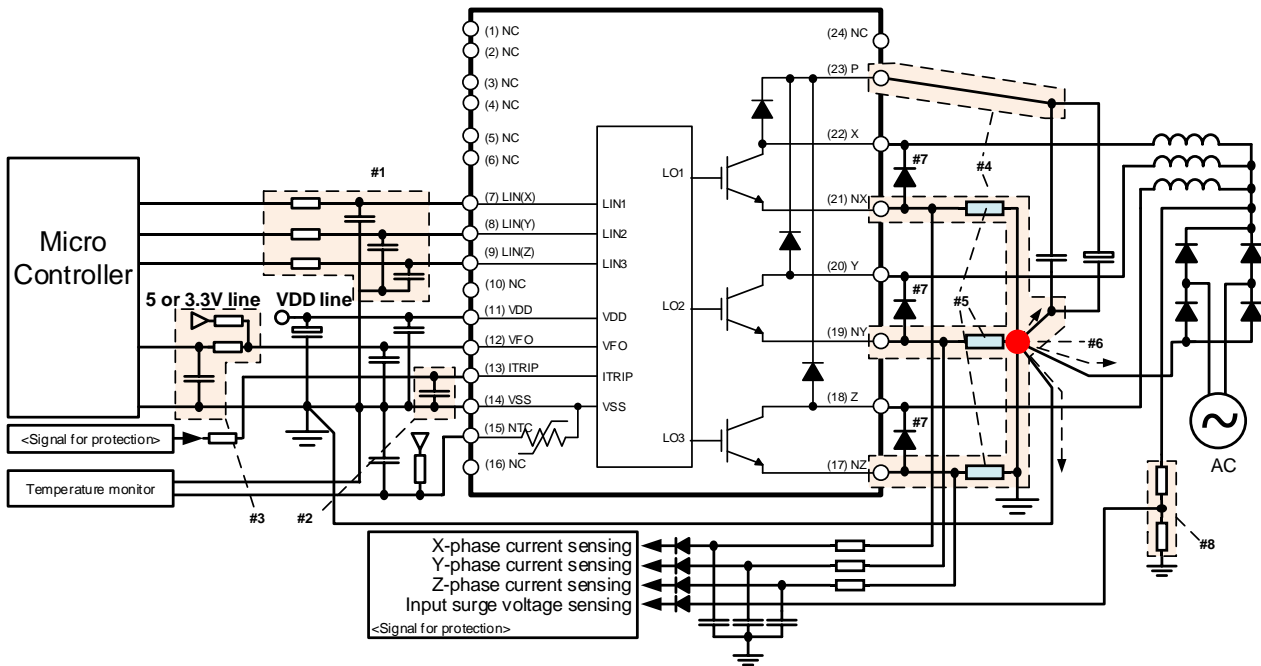

Figure 9 Typical application circuit

Because CIPOS™ Mini PFC has very high speed switching characteristics, considerable large surge voltage between P and N terminals and switching noise on signaling path are generated easily. Please pay attention to the below items for optimized application circuit design.

1. Input circuit

- To reduce input signal noise by high speed switching, the R_{IN} and C_{IN} filter circuit should be mounted. (100Ω, 1nF)
- C_{IN} should be placed as close to V_{SS} pin as possible.

2. Itrip circuit

- To prevent protection function errors, C_{ITRIP} should be placed as close to Itrip and V_{SS} pins as possible.

3. VFO circuit

- VFO output is an open drain output. This signal line should be pulled up to the positive side of the 5V/3.3V logic power supply with a proper resistor R_{PU} . It is recommended that RC filter be placed as close to the controller as possible.

4. Snubber capacitor

- The wiring between CIPOS™ Mini PFC and snubber capacitor including shunt resistor should be as short as possible.

5. Shunt resistor

- The shunt resistor of SMD type should be used for reducing its stray inductance.

6. Ground pattern

- Ground pattern should be separated at only one point of shunt resistor as short as possible.

7. It is mandatory to connect anti-parallel diode (2A, voltage rating higher than 650V) to PFC IGBT.

8. Input surge voltage protection circuit

- This protection circuit is necessary for PFC IGBT to be protected from excessive surge voltage.

Switching Times Definition

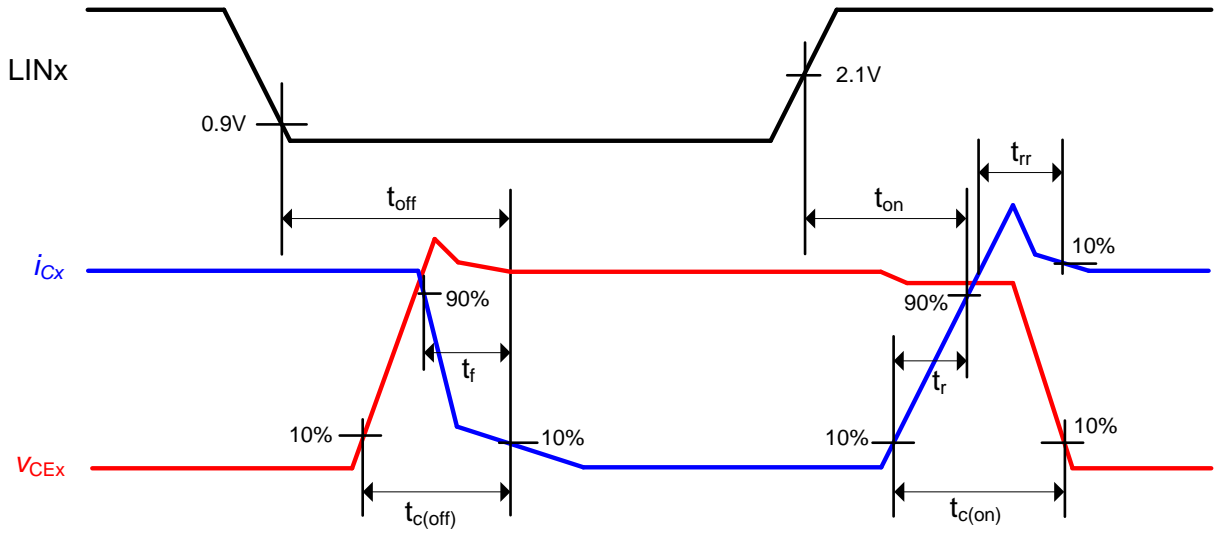
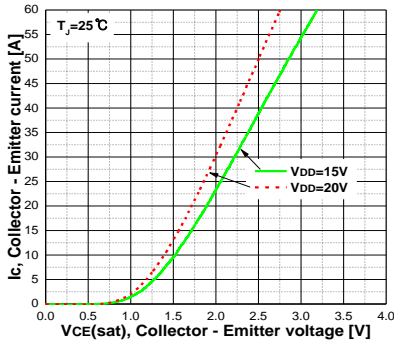
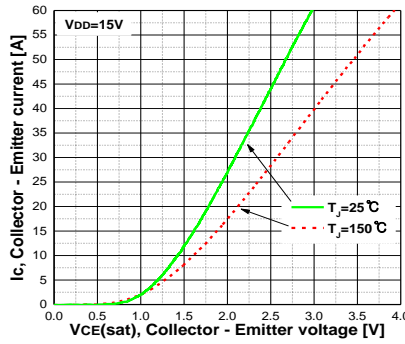

Figure 10 Switching times definition

Electrical characteristic



Typ. Collector – Emitter saturation voltage



Typ. Collector – Emitter saturation voltage

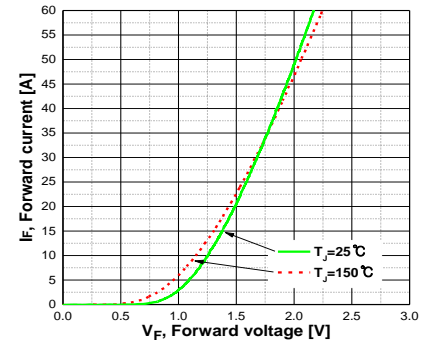

Typ. Diode forward voltage

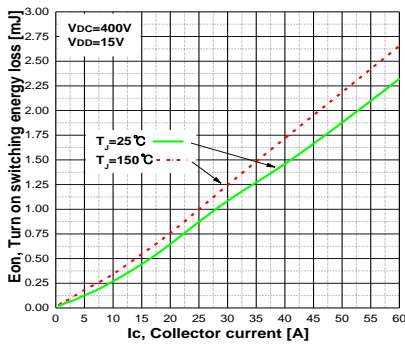

Typ. Turn on switching energy loss

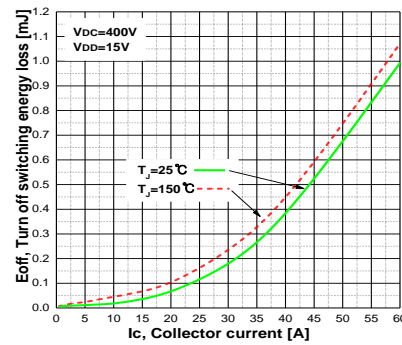

Typ. Turn off switching energy loss

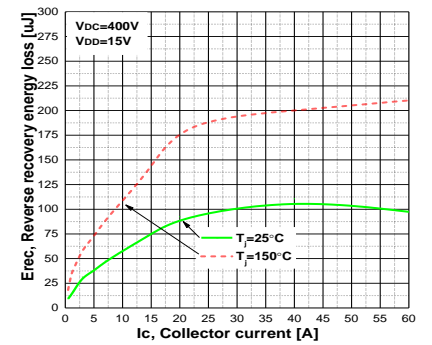

Typ. Reverse recovery energy loss

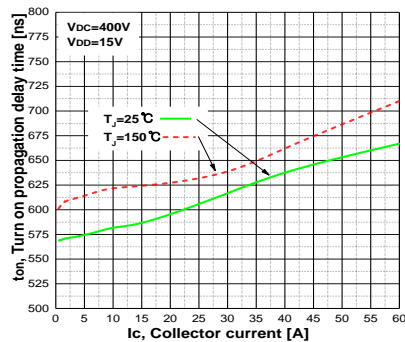

Typ. Turn on propagation delay time

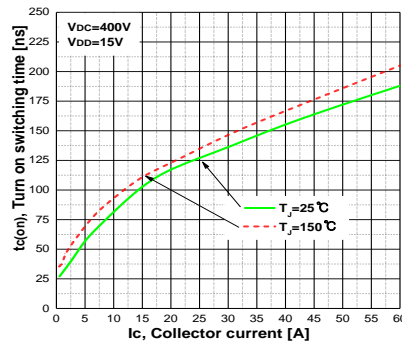

Typ. Turn on switching time

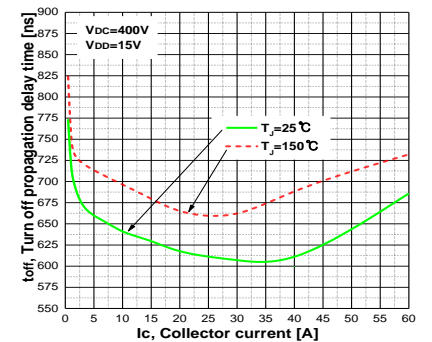

Typ. Turn off propagation delay time

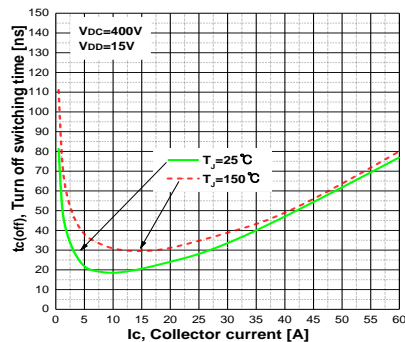

Typ. Turn off switching time

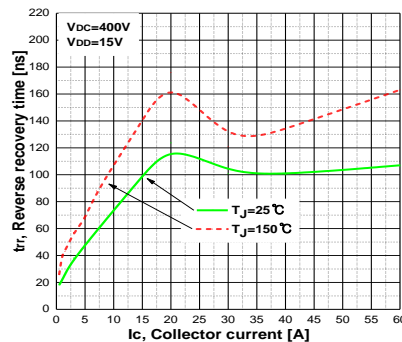

Typ. Reverse recovery time

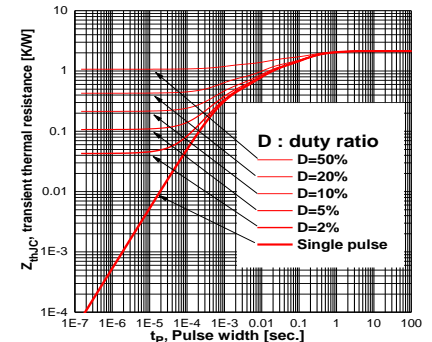

IGBT transient thermal resistance at all IGBTs operation

Package Outline

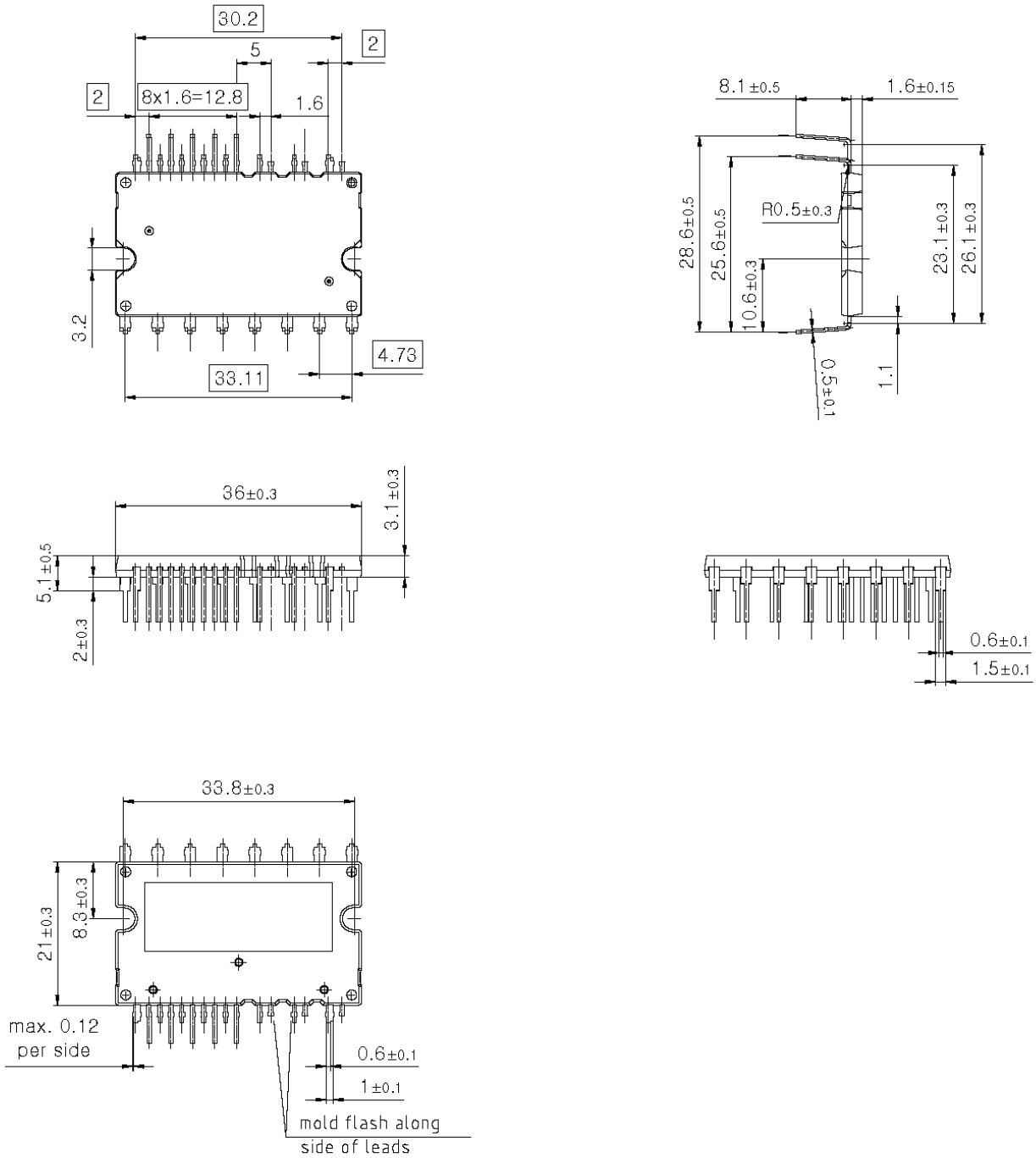

Revision history

Document version	Date of release	Description of changes
V 2.1	Jun. 2017	Package outline update
V 2.2	Sep. 2017	Maximum operating case temperature, T _c = 125°C

Trademarks

All referenced product or service names and trademarks are the property of their respective owners.

Edition 2017-09-06

Published by

Infineon Technologies AG

81726 München, Germany

© 2017 Infineon Technologies AG.

All Rights Reserved.

Do you have a question about this document?

Email: erratum@infineon.com

Document reference

ifx1

IMPORTANT NOTICE

The information given in this document shall in no event be regarded as a guarantee of conditions or characteristics ("Beschaffenheitsgarantie").

With respect to any examples, hints or any typical values stated herein and/or any information regarding the application of the product, Infineon Technologies hereby disclaims any and all warranties and liabilities of any kind, including without limitation warranties of non-infringement of intellectual property rights of any third party.

In addition, any information given in this document is subject to customer's compliance with its obligations stated in this document and any applicable legal requirements, norms and standards concerning customer's products and any use of the product of Infineon Technologies in customer's applications.

The data contained in this document is exclusively intended for technically trained staff. It is the responsibility of customer's technical departments to evaluate the suitability of the product for the intended application and the completeness of the product information given in this document with respect to such application.

For further information on the product, technology, delivery terms and conditions and prices please contact your nearest Infineon Technologies office (www.infineon.com).

Please note that this product is not qualified according to the AEC Q100 or AEC Q101 documents of the Automotive Electronics Council.

WARNINGS

Due to technical requirements products may contain dangerous substances. For information on the types in question please contact your nearest Infineon Technologies office.

Except as otherwise explicitly approved by Infineon Technologies in a written document signed by authorized representatives of Infineon Technologies, Infineon Technologies' products may not be used in any applications where a failure of the product or any consequences of the use thereof can reasonably be expected to result in personal injury.

Mouser Electronics

Authorized Distributor

Click to View Pricing, Inventory, Delivery & Lifecycle Information:

[Infineon:](#)

[IFCM20U65GD XKMA1](#)