

BFQ790

High Linearity RF Medium Power Amplifier

Product description

The BFQ790 is a single stage high linearity high gain driver amplifier based on Infineon's reliable and cost effective NPN silicon germanium technology. Not internally matched, the BFQ790 provides flexibility in high linearity applications.

Features

- High 3rd order intercept point OIP3 of 41 dBm @ 5 V, 250 mA in 1850 MHz and 2650 MHz Class A application circuits
- High compression point OP1dB of 27 dBm @ 5 V, 250 mA corresponding to 40% collector efficiency
- High power gain of 17 dB @ 5V, 250 mA in 1850 MHz Class A application circuit
- Exceptional ruggedness up to VSWR 10:1 at output
- High maximum RF input power PRFinmax of 18 dBm
- 100% test of proper die attach for reproducible thermal contact
- 100% DC and RF tested

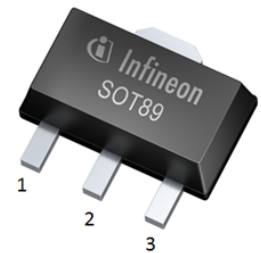

Applications

As

- high linear pre-driver amplifier, driver amplifier or power amplifier in the RF transmit chain

In

- Commercial / industrial wireless infrastructure
- ISM band wireless sensors
- Internet of Things
- Smart metering
- Automotive radio links
- Solid state Microwave ovens

Attention: ESD (Electrostatic discharge) sensitive device, observe handling precautions

Product validation

Qualified for industrial applications according to the relevant tests of JEDEC47/20/22

Device Information

Table 1 Device Information

Product Name / Ordering Code	Package	Pin Configuration			Marking
BFQ790 / BFQ790H6327XTSA1	SOT89	1 = B	2 = E	3 = C	R3

Table of contents

	Product description	1
	Features	1
	Applications	1
	Product validation	1
	Device Information	1
	Table of contents	2
1	Absolute Maximum Ratings	3
2	Recommended Operating Conditions	4
3	Thermal Characteristics	5
4	Electrical Performance in Test Fixture	6
4.1	DC Parameter Table	6
4.2	AC Parameter Tables	6
4.3	Characteristic DC Diagrams	9
4.4	Characteristic AC Diagrams	11
5	Simulation Data	20
6	Package Information SOT89	21
	Revision History	22
	Trademarks	23

Absolute Maximum Ratings

1 Absolute Maximum Ratings

Table 2 Absolute Maximum Ratings at $T_A = 25\text{ °C}$ (unless otherwise specified)

Parameter	Symbol	Values		Unit	Note or Test Condition
		Min.	Max.		
Collector emitter voltage	V_{CE}	–	6.1	V	$T_A = 25\text{ °C}$ $T_A = 40\text{ °C}$
Collector base voltage	V_{CB}	–	18	V	–
Instantaneous total base emitter reverse voltage	V_{BE}	-2.0	–	V	DC + RF swing
Instantaneous total collector current	i_C	–	600	mA	DC + RF swing
DC collector current	I_C	–	300	mA	–
DC base current	I_B	–	10	mA	–
RF input power	P_{RFIn}	–	18	dBm	In- and output matched
Mismatch at output	VSWR	–	10:1		In compression, over all phase angles
ESD stress pulse	V_{ESD}	-500	500	V	HBM, all pins, acc. to ANSI / ESDA / JEDEC JS-001-2012
Dissipated power	P_{DISS}	–	1500	mW	$T_S \leq 112.5\text{ °C}^{1)}$, regard derating curve in Figure 1 .
Junction temperature	T_J	–	150	°C	–
Operating case temperature	T_A	-40	105 ²⁾	°C	–
Storage temperature	T_{Stg}	-55	150	°C	–

Attention: *Stresses above the max. values listed here may cause permanent damage to the device. Exposure to absolute maximum rating conditions for extended periods may affect device reliability. Maximum ratings are absolute ratings; exceeding only one of these values may cause irreversible damage to the component.*

¹ T_S is the soldering point temperature. T_S is measured on the emitter lead at the soldering point of the pcb.

² At the same time regard $T_{J,max}$.

Recommended Operating Conditions

2 Recommended Operating Conditions

This following table shows examples of recommended operating conditions. As long as maximum ratings are regarded operation outside these conditions is permitted, but increases failure rate and reduces lifetime. For further information refer to the quality report available on the BFQ790 internet page.

Table 3 Recommended Operating Conditions

Operating Mode	Ambient Temperature ¹⁾	Collector Current	DC Power ²⁾	RF Output Power ³⁾	Efficiency ⁴⁾	Dissipated Power ⁵⁾	Thermal Resistance of pcb ⁶⁾	Junction Temperature ⁷⁾
	T _A [°C]	I _C [mA]	P _{DC} [mW]	P _{RFout} [mW] (dBm)	η [%]	P _{diss} [mW]	R _{THSA} [K/W]	T _J [°C]
Compression	55	250	1250	500 (27)	40	750	45	110
Final stage	55	200	1000	250 (24)	25	750	45	110
High T _A	85	120	600	50 (17)	8.5	550	20	110
Maximum T _A	105	50	250	100 (20)	40	150	30	110
Linear	55	150	750	50 (17)	7	700	50	110
Very Linear	55	250	1250	50 (17)	4	1200	20	110

¹ Is the operating case temperature respectively of the heatsink.

² $P_{DC} = V_{CE} \cdot I_C$ with $V_{CE} = 5\text{ V}$.

³ RF power delivered to the load, $P_{RFout} = \eta \cdot P_{DC}$.

⁴ Efficiency of the conversion from DC power to RF power, $\eta = P_{RFout} / P_{DC}$ (collector efficiency).

⁵ $P_{diss} = P_{DC} - P_{RFout}$. The RF output power P_{RFout} delivered to the load reduces the power P_{diss} to be dissipated by the device. This means a good output match is recommended.

⁶ R_{THSA} is the thermal resistance of the pcb including heat sink, that is between the soldering point S and the ambient A. Regard the impact of R_{THSA} on the junction temperature T_J , see below. The thermal design of the pcb, respectively R_{THSA} , has to be adjusted to the intended operating mode.

⁷ $T_J = T_A + P_{diss} \cdot R_{THJA}$. $R_{THJA} = R_{THJS} + R_{THSA}$. R_{THJA} is the thermal resistance between the transistor junction J and the ambient A. R_{THJS} is the combined thermal resistance of die and package, which is 25 K/W for the BFQ790,, see [Chapter 3](#).

Thermal Characteristics

3 Thermal Characteristics

Table 4 Thermal Resistance

Parameter	Symbol	Values			Unit	Note or Test Condition
		Min.	Typ.	Max.		
Junction - soldering point	R_{thJS}	-	25	-	K/W	-

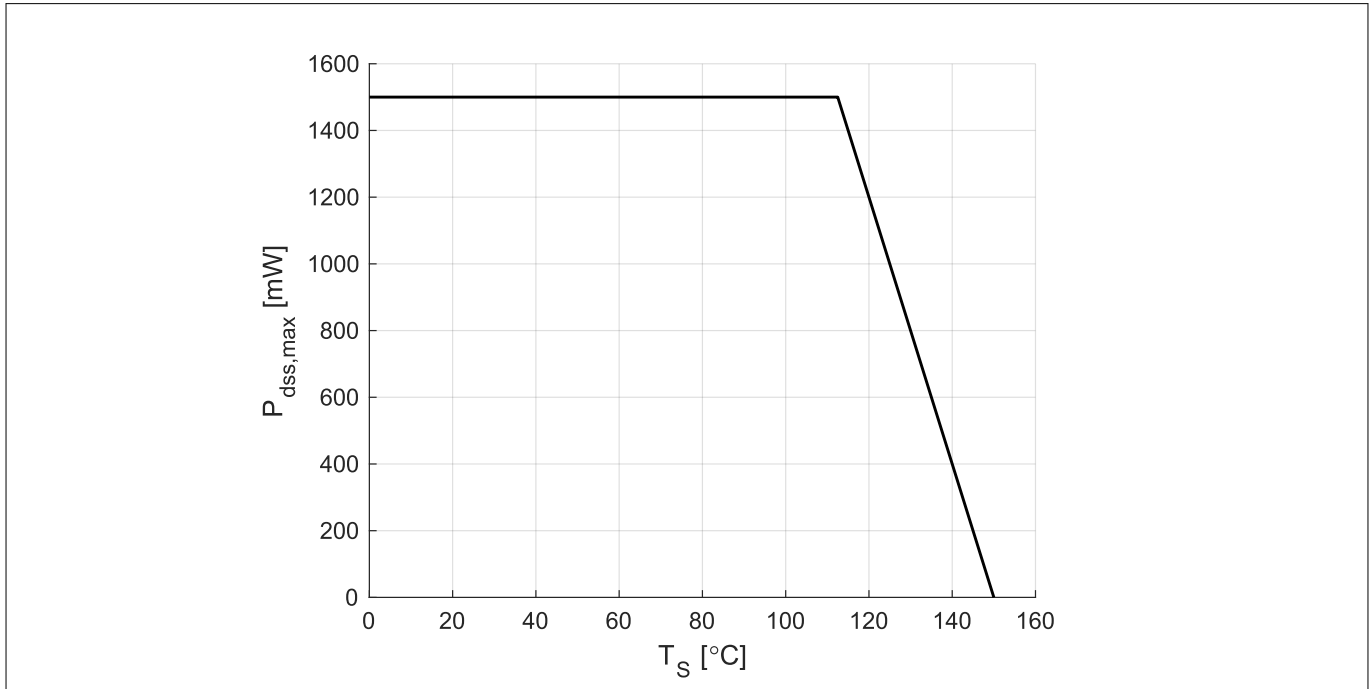

Figure 1 Absolute Maximum Power Dissipation $P_{diss,max}$ vs. T_s

Note: In the horizontal part of the derating curve the maximum power dissipation is given by $P_{diss,max} \approx V_{CE,max} \cdot I_{C,max}$. In this part the junction temperature T_J is lower than $T_{J,max}$. In the declining slope it is $T_J = T_{J,max}$, $P_{diss,max}$ has to be reduced according to the curve in order not to exceed $T_{J,max}$. It is $T_{J,max} = T_s + P_{diss,max} \cdot R_{thJS}$.

Electrical Performance in Test Fixture

4 Electrical Performance in Test Fixture

4.1 DC Parameter Table

Table 5 DC Characteristics at $T_A = 25\text{ }^\circ\text{C}$

Parameter	Symbol	Values			Unit	Note or Test Condition
		Min.	Typ.	Max.		
Collector emitter breakdown voltage	$V_{(BR)CEO}$	6.1	6.7	–	V	$I_C = 1\text{ mA}$, open base
Collector emitter leakage current	I_{CES}	–	1	40 ¹⁾	nA	$V_{CE} = 8\text{ V}$, $V_{BE} = 0\text{ V}$ $V_{CE} = 18\text{ V}$, $V_{BE} = 0\text{ V}$ E-B short circuited
		–	0.1	3	μA	
Collector base leakage current	I_{CBO}	–	1	40 ¹⁾	nA	$V_{CB} = 8\text{ V}$, $I_E = 0$ Open emitter
Emitter base leakage current	I_{EBO}	–	1	40 ¹⁾	μA	$V_{EB} = 0.5\text{ V}$, $I_C = 0$ Open collector
DC current gain	h_{FE}	60	120	180		$V_{CE} = 5\text{ V}$, $I_C = 250\text{ mA}$ Pulse measured ²⁾

4.2 AC Parameter Tables

Table 6 General AC Characteristics at $T_A = 25\text{ }^\circ\text{C}$

Parameter	Symbol	Values			Unit	Note or Test Condition
		Min.	Typ.	Max.		
Transition frequency	f_T	–	20	–	GHz	$V_{CE} = 5\text{ V}$, $I_C = 250\text{ mA}$, $f = 0.5\text{ GHz}$
Collector base capacitance	C_{CB}	–	1.1	–	pF	$V_{CB} = 5\text{ V}$, $V_{BE} = 0\text{ V}$, $f = 1\text{ MHz}$ Emitter grounded
Collector emitter capacitance	C_{CE}	–	2.2	–	pF	$V_{CE} = 5\text{ V}$, $V_{BE} = 0\text{ V}$, $f = 1\text{ MHz}$ Base grounded
Emitter base capacitance	C_{EB}	–	9.4	–	pF	$V_{EB} = 0.5\text{ V}$, $V_{CB} = 0\text{ V}$, $f = 1\text{ MHz}$ Collector grounded

¹ Upper spec value limited by the cycle time of the 100% test.

² Pulse width is 1 ms, duty cycle 10%. Regard that the current gain h_{FE} depends on the junction temperature T_J and T_J amongst others from the thermal resistance R_{THSA} of the pcb, see notes to [Table 3](#). Hence the h_{FE} specified in this datasheet must not be the same as in the application. It is highly recommended to apply circuit design techniques to make the collector current I_C independent on the h_{FE} production variation and temperature effects.

Electrical Performance in Test Fixture

Measurement setup for the AC characteristics shown in [Table 7](#) to [Table 10](#) is a test fixture with Bias T's and tuners to adjust the source and load impedances in a 50 Ω system, $T_A = 25\text{ °C}$.

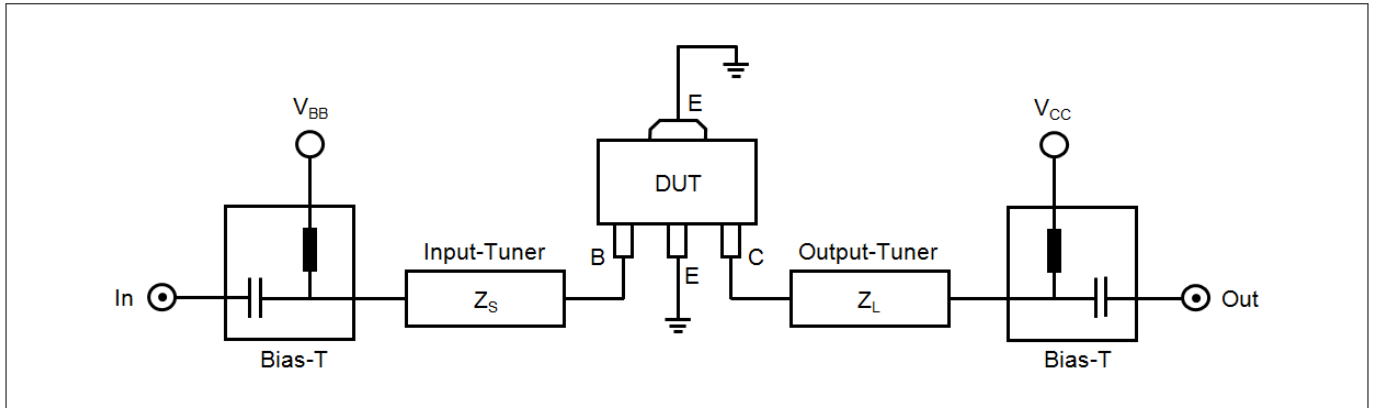

Figure 2 BFQ790 Testing Circuit

Table 7 AC Characteristics, $V_{CE} = 5\text{ V}$, $f = 0.9\text{ GHz}$

Parameter	Symbol	Values			Unit	Note or Test Condition
		Min.	Typ.	Max.		
Power Gain					dB	
Maximum power gain	G_{ms}	-	23	-		$I_C = 250\text{ mA}$
Transducer gain	$ S_{21} ^2$	-	13	-		$I_C = 250\text{ mA}$
Minimum Noise Figure					dB	$Z_S = Z_{Sopt}$
Minimum noise figure	NF_{min}	-	2.5	-		$I_C = 70\text{ mA}$
Linearity					dBm	$Z_L = Z_{Lopt}$
1 dB compression point at output	OP1dB	-	27	-		$I_C = 250\text{ mA}$
3rd order intercept point at output	OIP3	-	38.5	-		$I_C = 250\text{ mA}$

Table 8 AC Characteristics, $V_{CE} = 5\text{ V}$, $f = 1.8\text{ GHz}$

Parameter	Symbol	Values			Unit	Note or Test Condition
		Min.	Typ.	Max.		
Power Gain					dB	
Maximum power gain	G_{ms}	-	18.5	-		$I_C = 250\text{ mA}$
Transducer gain	$ S_{21} ^2$	-	7.5	-		$I_C = 250\text{ mA}$
Minimum Noise Figure					dB	$Z_S = Z_{Sopt}$
Minimum noise figure	NF_{min}	-	2.6	-		$I_C = 70\text{ mA}$
Linearity					dBm	$Z_L = Z_{Lopt}$
1 dB compression point at output	OP1dB	-	27	-		$I_C = 250\text{ mA}$
3rd order intercept point at output	OIP3	-	38.5	-		$I_C = 250\text{ mA}$

Electrical Performance in Test Fixture

Table 9 AC Characteristics, $V_{CE} = 5\text{ V}$, $f = 2.6\text{ GHz}$

Parameter	Symbol	Values			Unit	Note or Test Condition
		Min.	Typ.	Max.		
Power Gain					dB	
Maximum power gain	G_{ms}	–	16	–		$I_C = 250\text{ mA}$
Transducer gain	$ S_{21} ^2$	–	5.5	–		$I_C = 250\text{ mA}$
Minimum Noise Figure					dB	$Z_S = Z_{Sopt}$
Minimum noise figure	NF_{min}	–	3.0	–		$I_C = 70\text{ mA}$
Linearity					dBm	$Z_L = Z_{Lopt}$
1 dB compression point at output	OP1dB	–	27	–		$I_C = 250\text{ mA}$
3rd order intercept point at output	OIP3	–	38.5	–		$I_C = 250\text{ mA}$

Table 10 AC Characteristics, $V_{CE} = 5\text{ V}$, $f = 3.5\text{ GHz}$

Parameter	Symbol	Values			Unit	Note or Test Condition
		Min.	Typ.	Max.		
Power Gain					dB	
Maximum power gain	G_{ms}	–	13	–		$I_C = 250\text{ mA}$
Transducer gain	$ S_{21} ^2$	–	3	–		$I_C = 250\text{ mA}$
Minimum Noise Figure					dB	$Z_S = Z_{Sopt}$
Minimum noise figure	NF_{min}	–	3.4	–		$I_C = 70\text{ mA}$
Linearity					dBm	$Z_L = Z_{Lopt}$
1 dB compression point at output	OP1dB	–	27	–		$I_C = 250\text{ mA}$
3rd order intercept point at output	OIP3	–	38.5	–		$I_C = 250\text{ mA}$

Electrical Performance in Test Fixture

4.3 Characteristic DC Diagrams

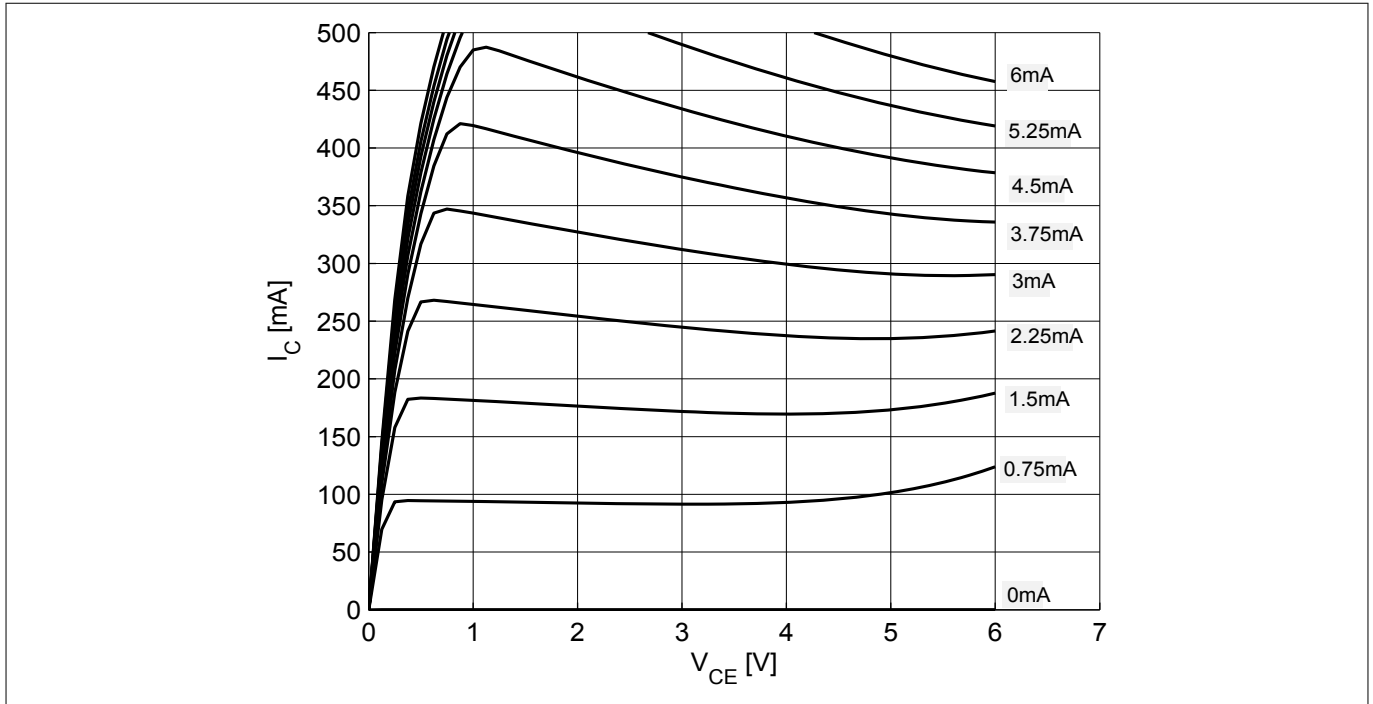

Figure 3 Collector Current I_C vs. V_{CE} , I_B = Parameter

Note: Regard absolute maximum ratings for I_C , V_{CE} and P_{diss}

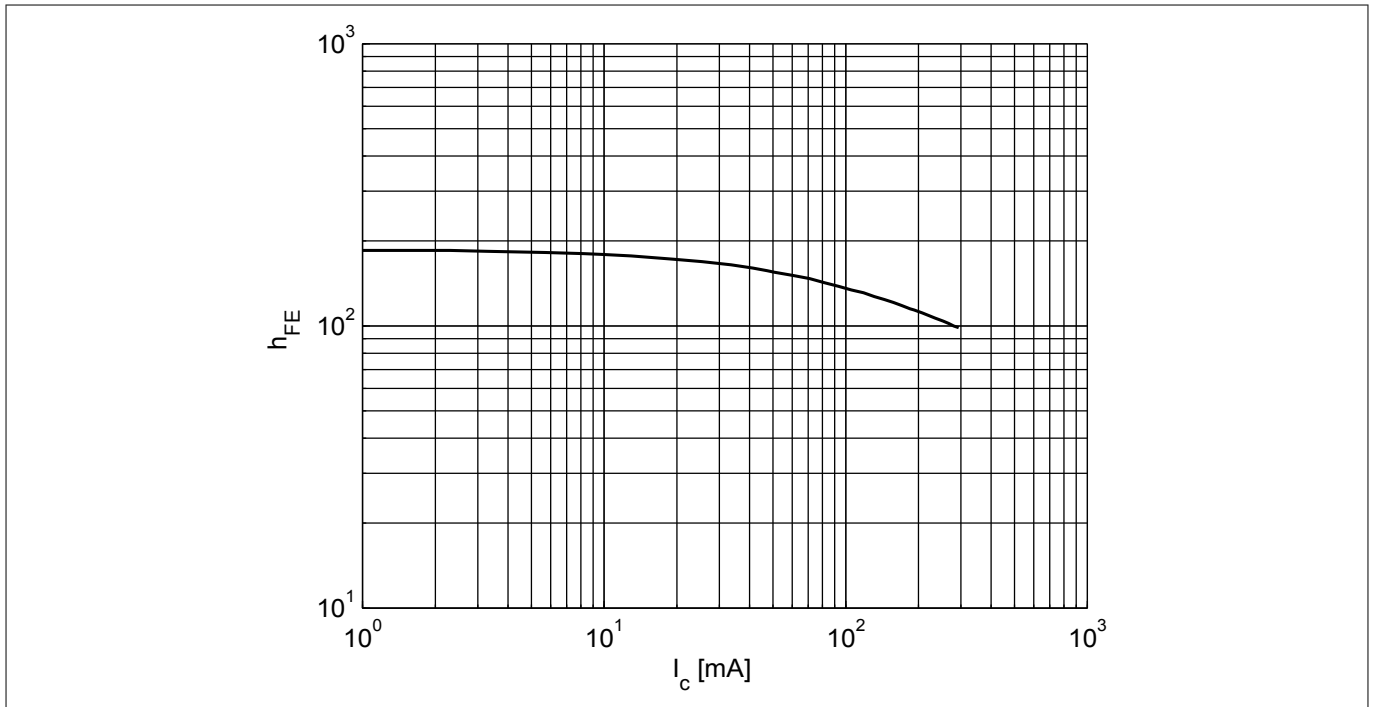

Figure 4 DC Current Gain h_{FE} vs. I_C at $V_{CE} = 5 V$

Electrical Performance in Test Fixture

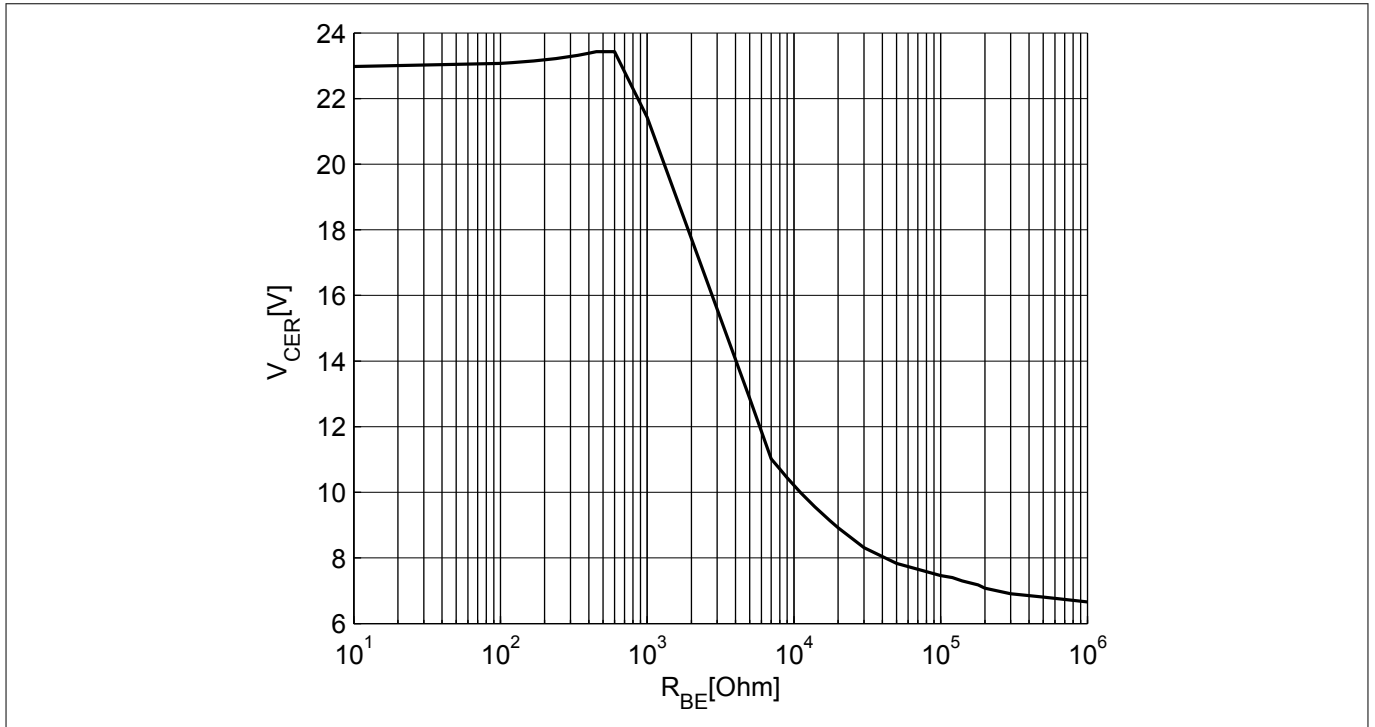

Figure 5 Collector Emitter Breakdown Voltage BV_{CER} vs. Resistor $R_{B/GND}$

Note: The above figure shows the collector-emitter breakdown voltage BV_{CER} with a resistor $R_{B/GND}$ between base and emitter. Only for very high $R_{B/GND}$ values ("open base") the breakdown voltage is as low as BV_{CEO} (here 6.7 V). With decreasing $R_{B/GND}$ values BV_{CER} increases, e.g. at $R_{B/GND}=10$ kOhm to $BV_{CER}=10$ V. In the application the biasing base resistance together with block capacitors take over the function of $R_{B/GND}$ and allows the RF voltage amplitude to swing up to voltages much higher than BV_{CEO} , no clipping occurs. Due to this effect the transistor can be biased at $V_{CE}=5$ V and still high RF output powers achieved, see the [OP1dB](#) values reported in [Chapter 4.2](#).

Electrical Performance in Test Fixture

4.4 Characteristic AC Diagrams

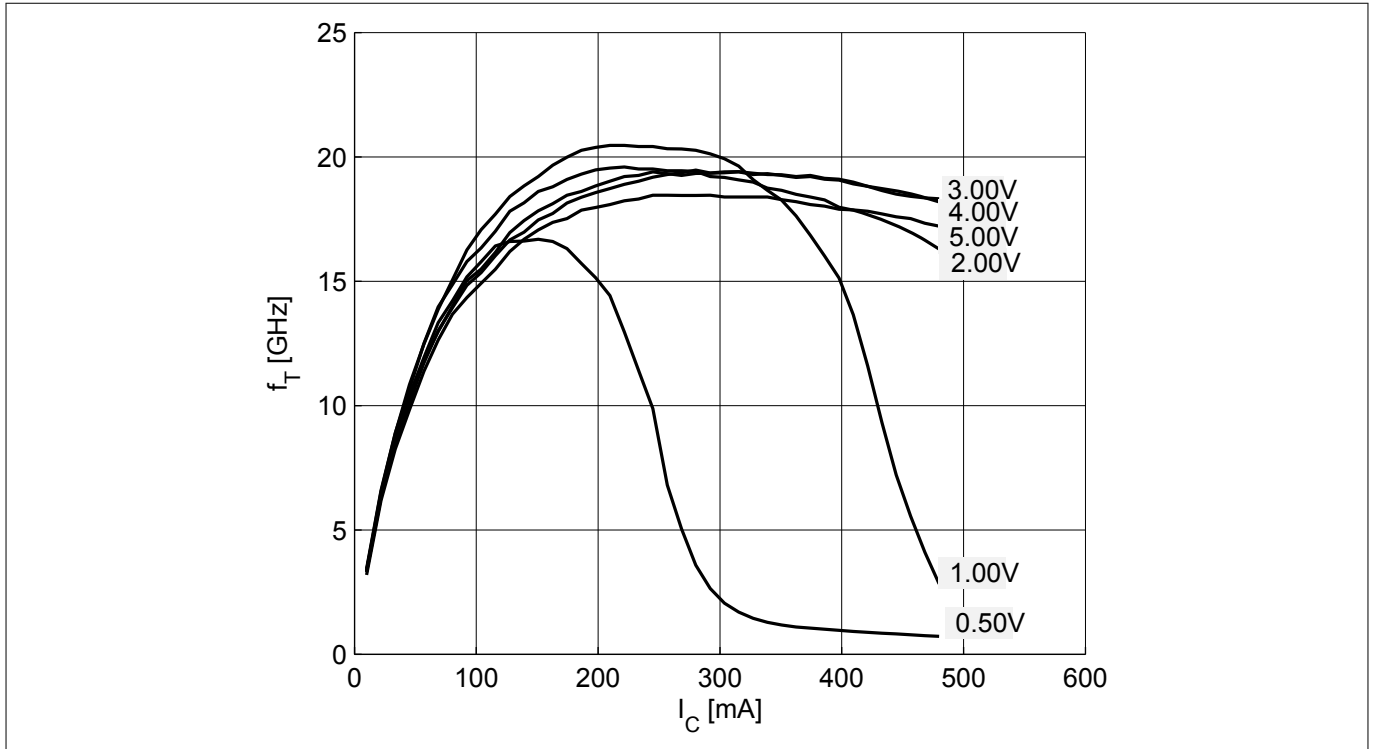

Figure 6 Transition Frequency f_T vs. I_C , V_{CE} = Parameter

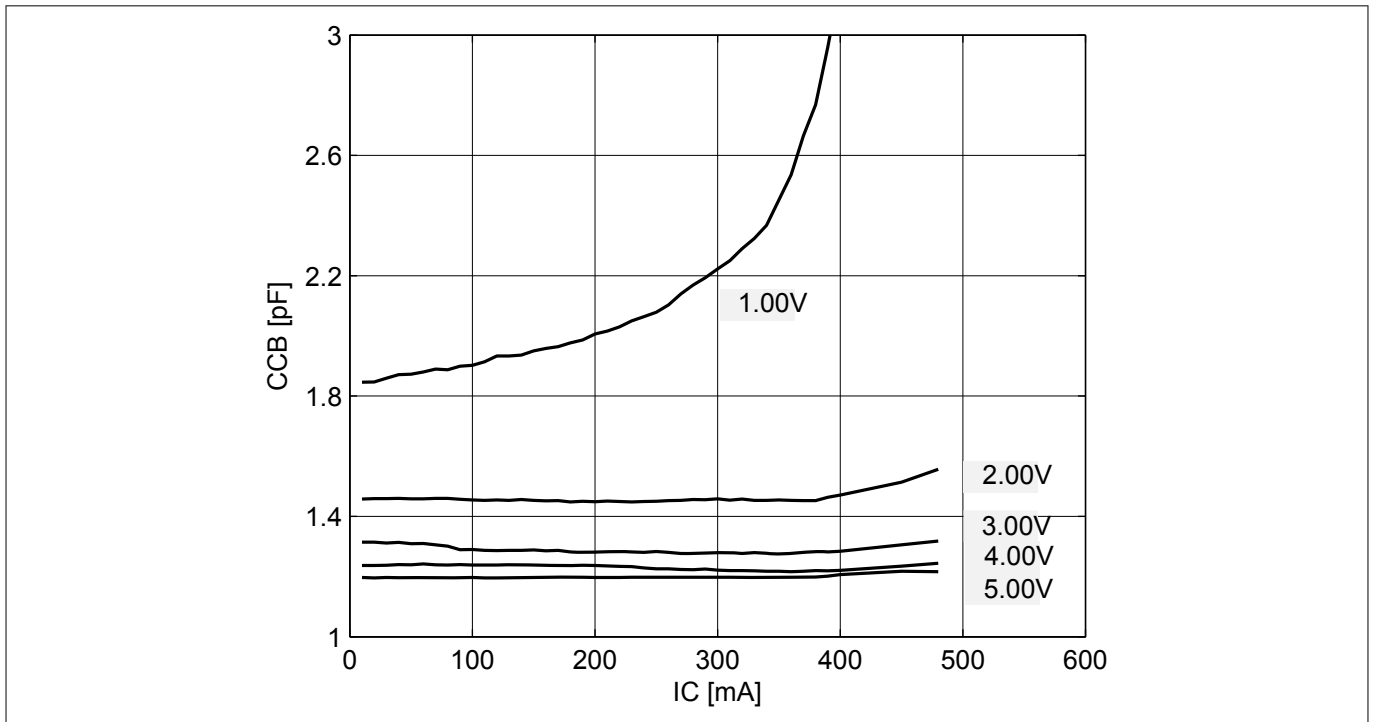

Figure 7 Collector Base Capacitance C_{CB} vs. I_C at $f = 30$ MHz, V_{CB} = Parameter

Electrical Performance in Test Fixture

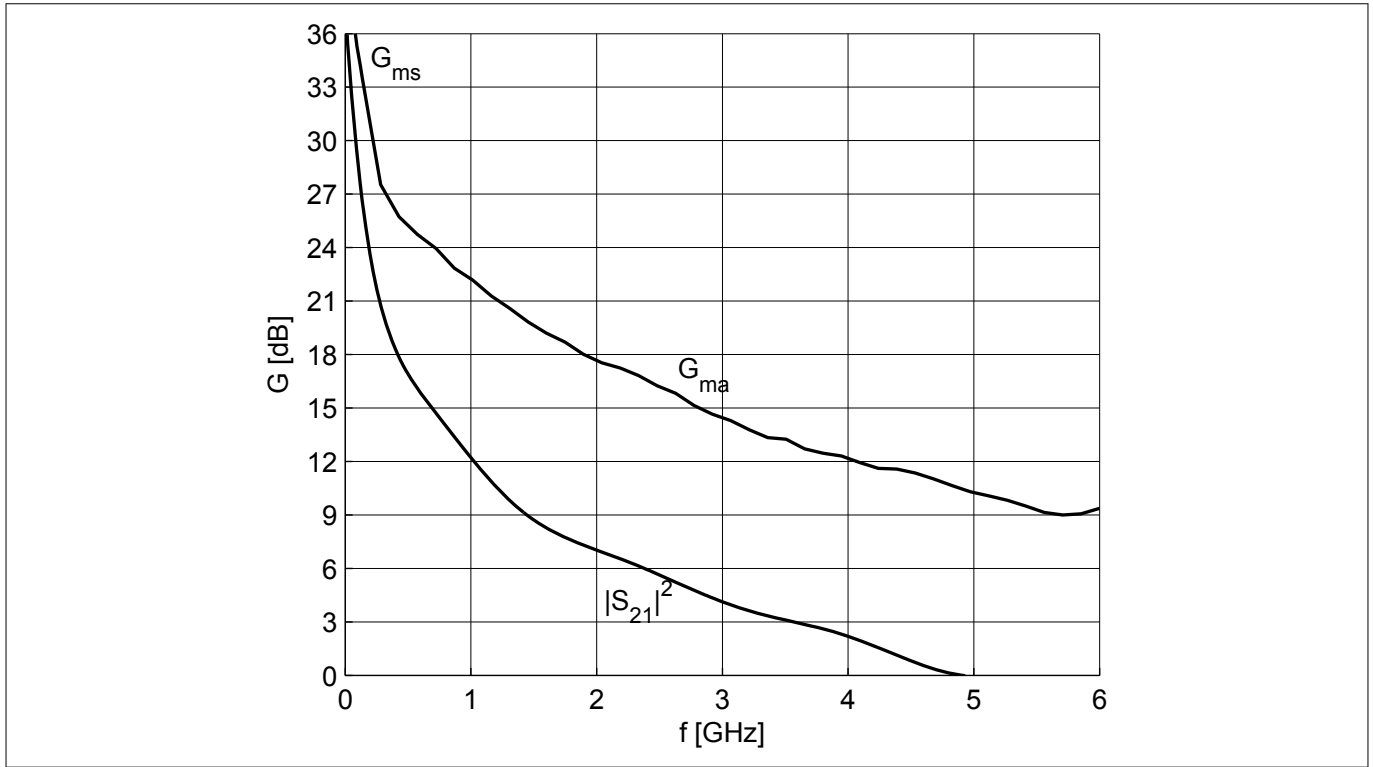

Figure 8 Gain G_{ms} , G_{ma} , $|S_{21}|^2$ vs. f at $V_{CE} = 5\text{ V}$, $I_C = 250\text{ mA}$

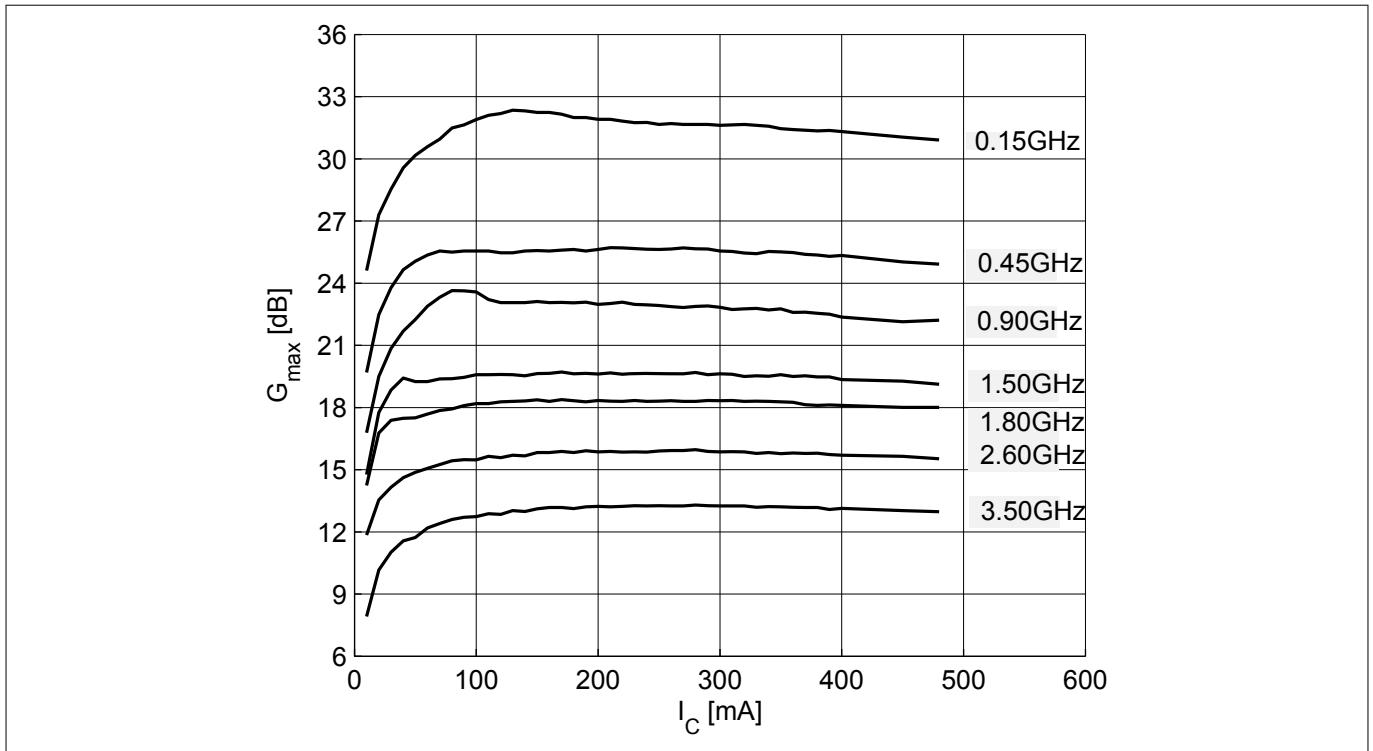

Figure 9 Maximum Power Gain G_{max} vs. I_C at $V_{CE} = 5\text{ V}$, $f = \text{Parameter}$

Electrical Performance in Test Fixture

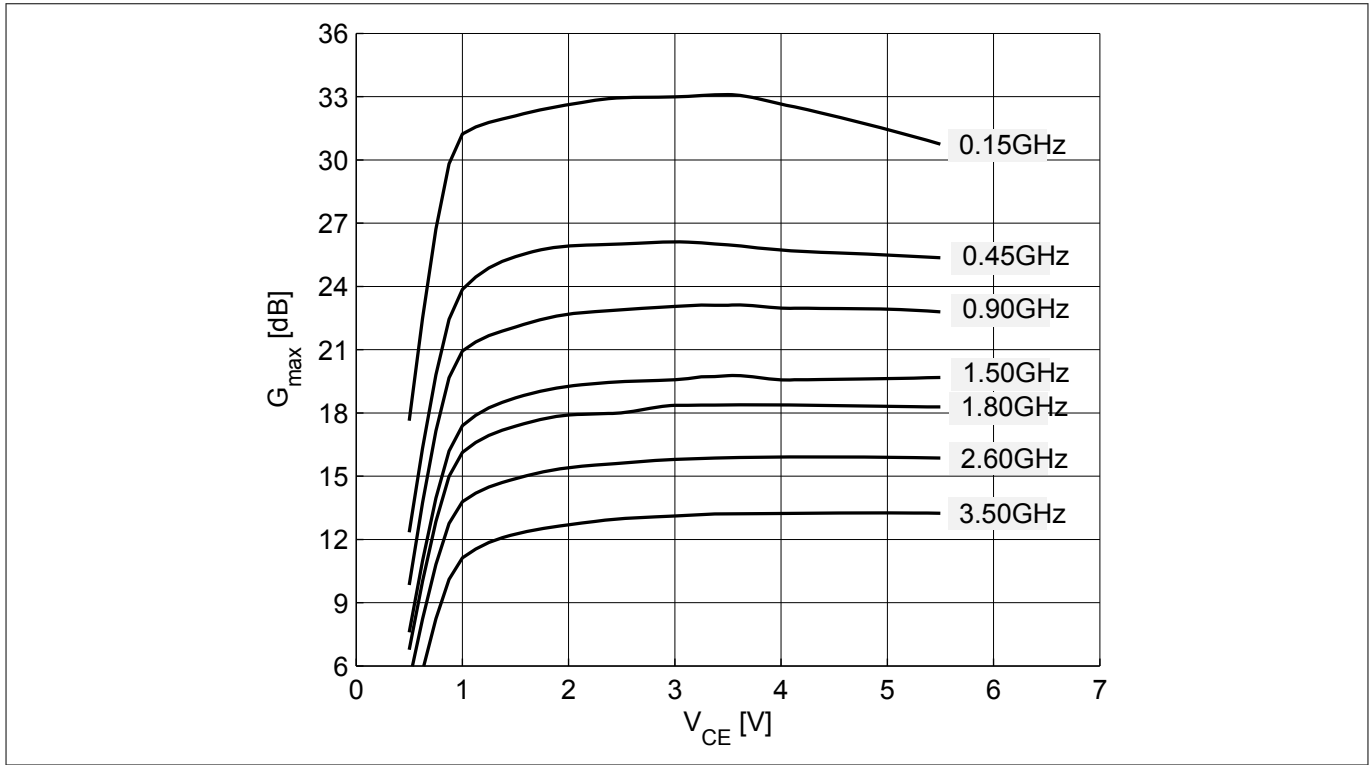

Figure 10 Maximum Power Gain G_{max} vs. V_{CE} at $I_C = 250$ mA, $f =$ Parameter

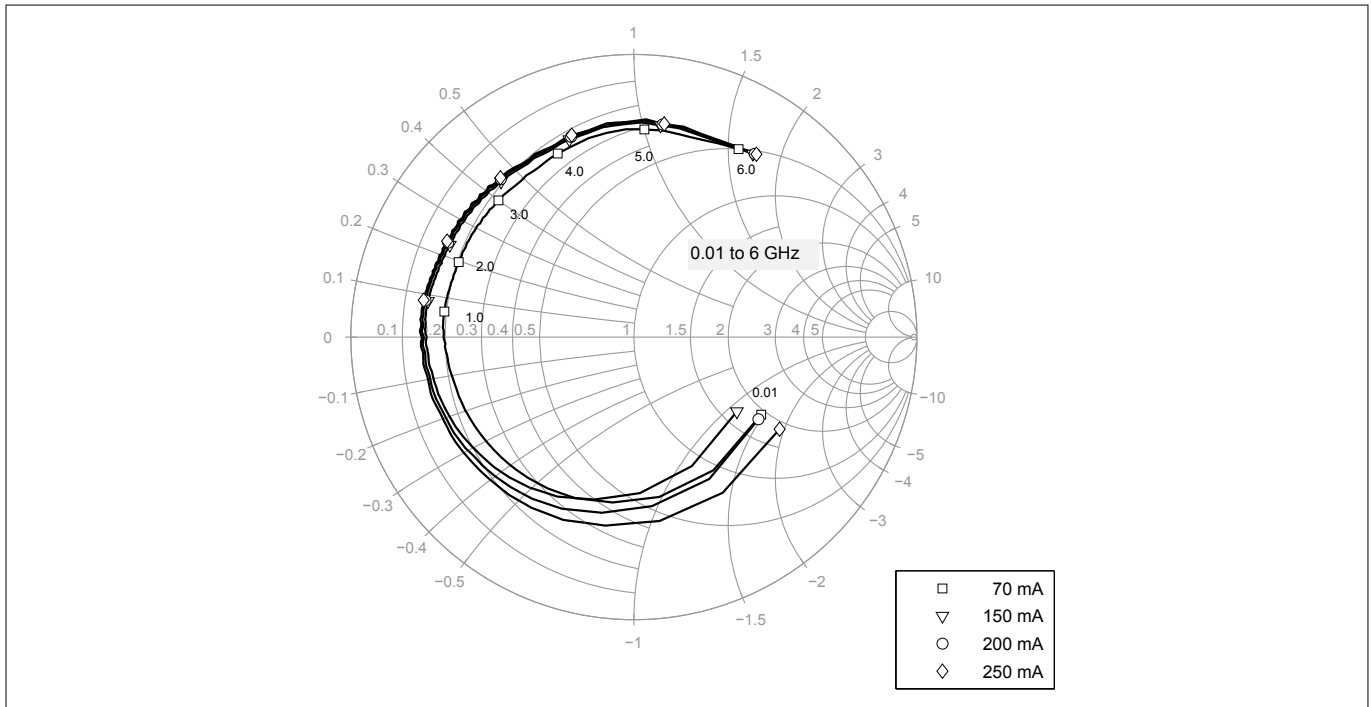

Figure 11 Output Reflection Coefficient S_{22} vs. f at $V_{CE} = 5$ V, $I_C =$ Parameter

Electrical Performance in Test Fixture

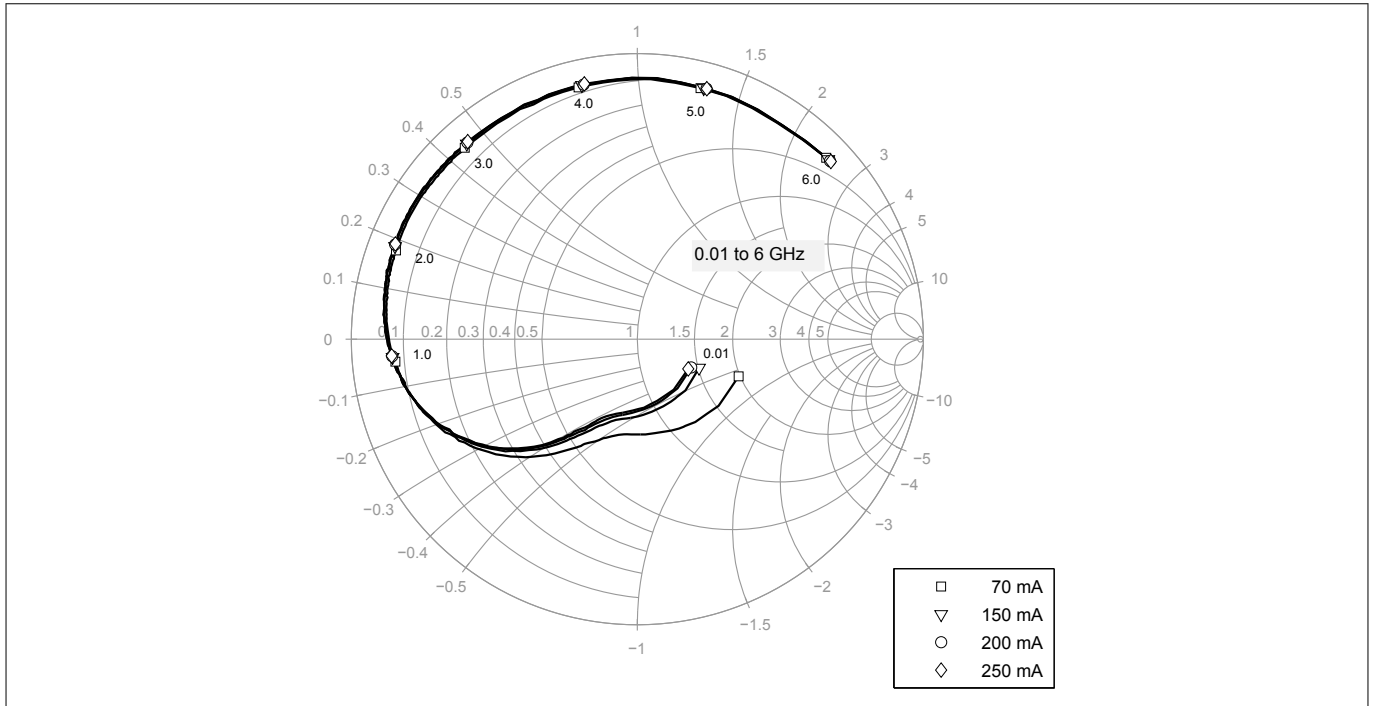

Figure 12 Input Reflection Coefficient S_{11} vs. f at $V_{CE} = 5\text{ V}$, $I_C = \text{Parameter}$

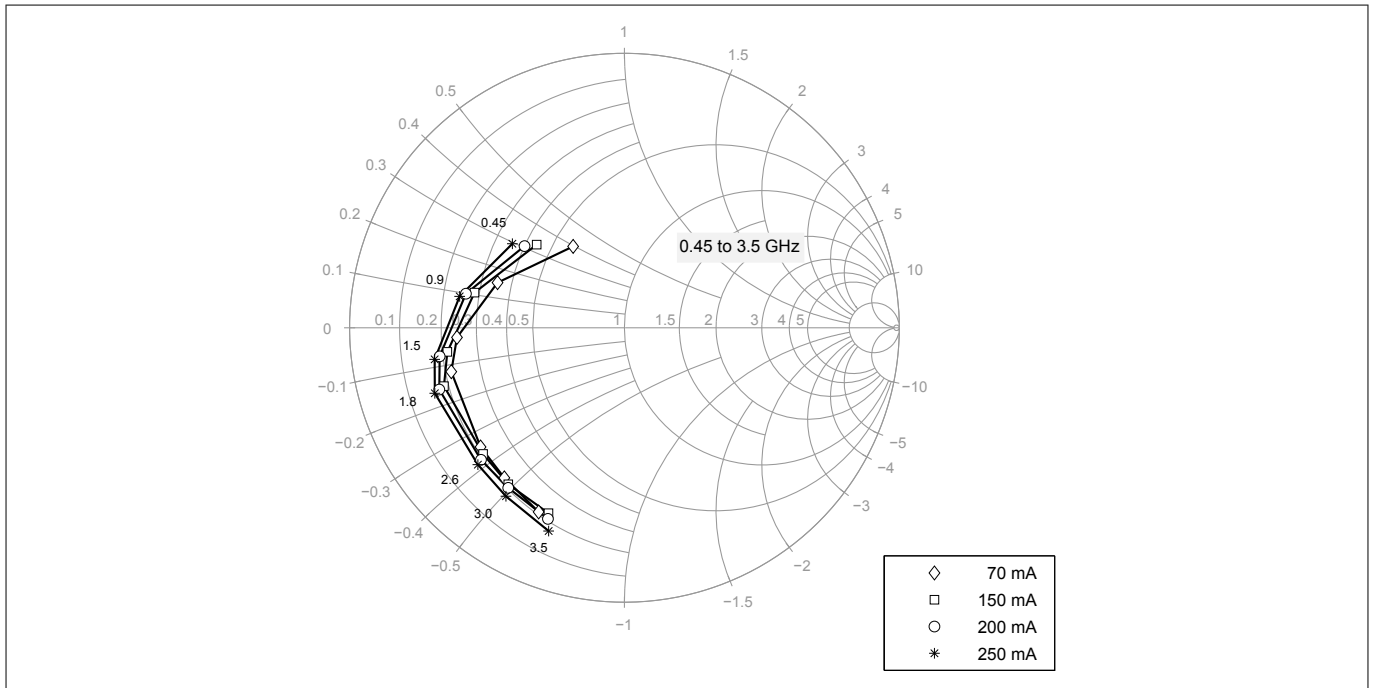

Figure 13 Source Impedance Z_{Sopt} for Minimum Noise Figure vs. f at $V_{CE} = 5\text{ V}$, $I_C = \text{Parameter}$

Electrical Performance in Test Fixture

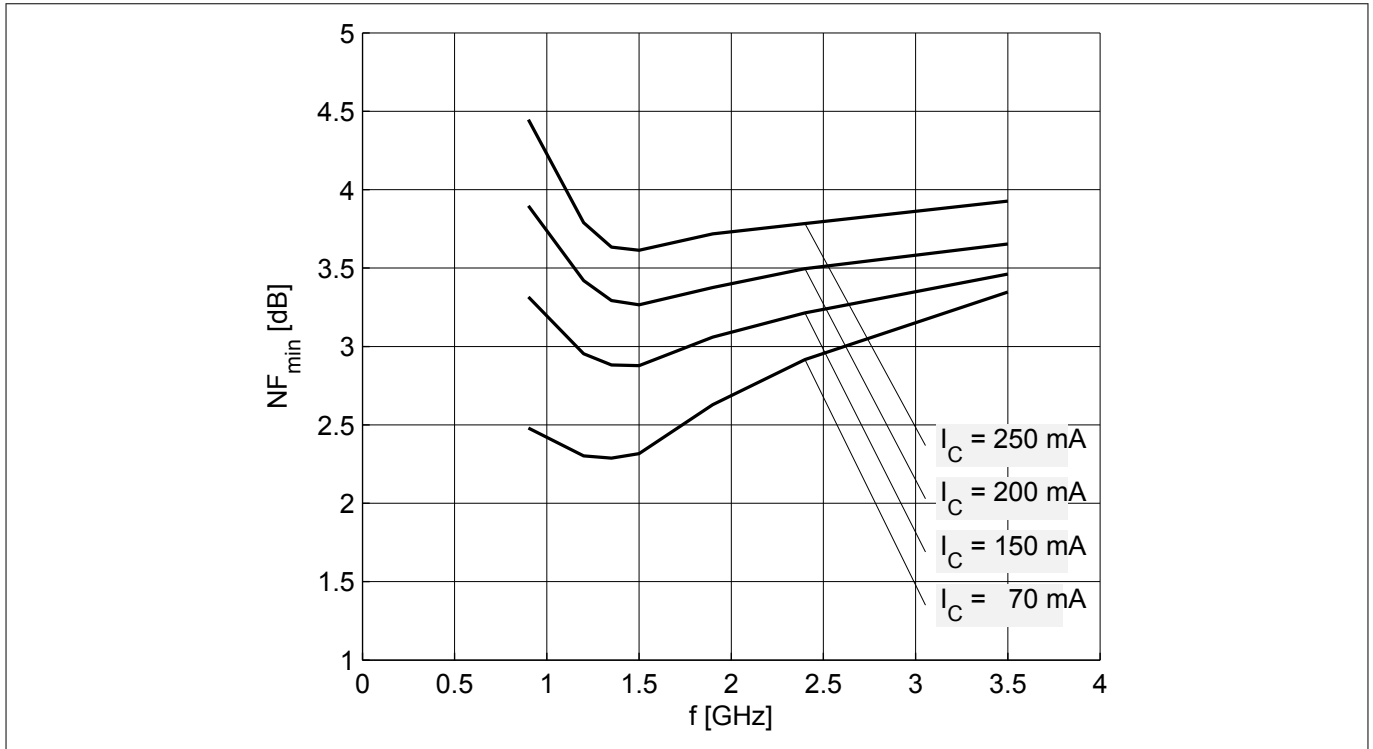

Figure 14 Noise Figure NF_{min} vs. f at $V_{CE} = 5$ V, $Z_S = Z_{Sopt}$, $I_C =$ Parameter

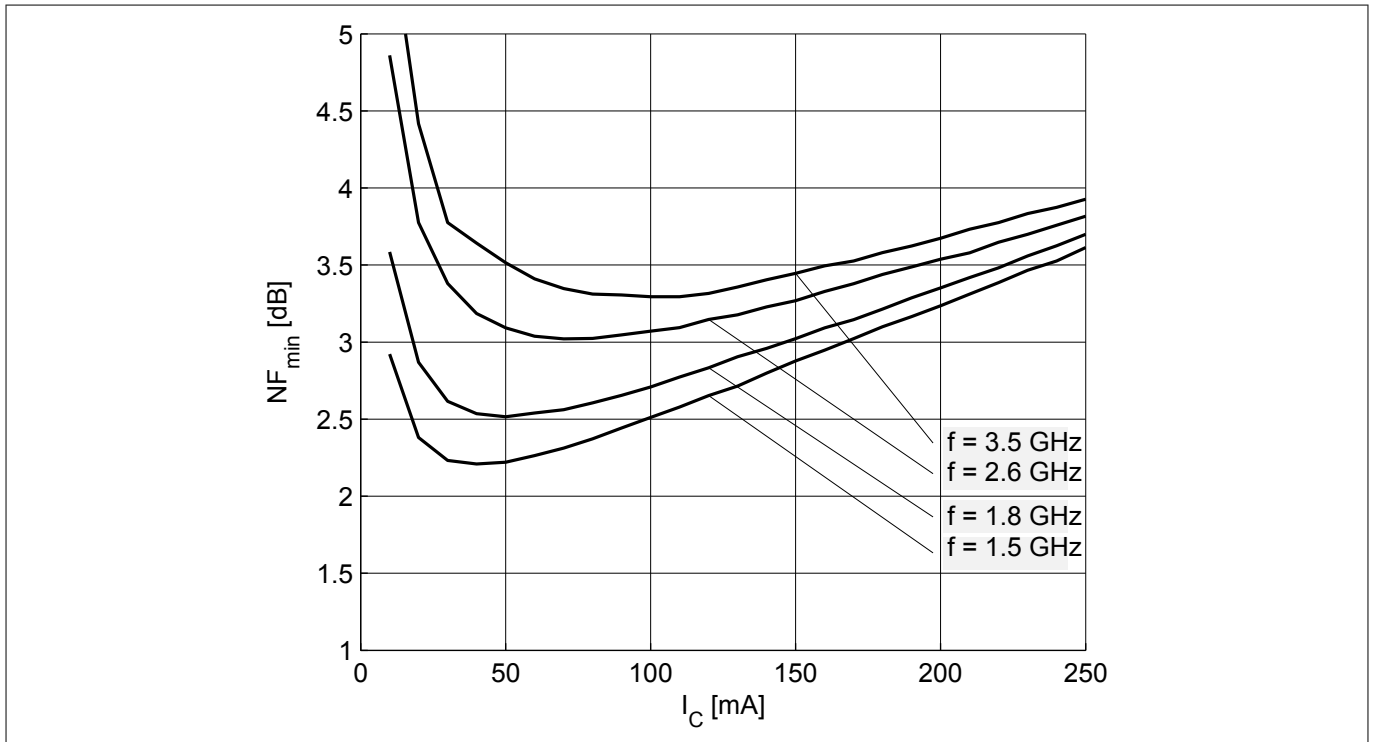

Figure 15 Noise Figure NF_{min} vs. I_C at $V_{CE} = 5$ V, $Z_S = Z_{Sopt}$, $f =$ Parameter

Electrical Performance in Test Fixture

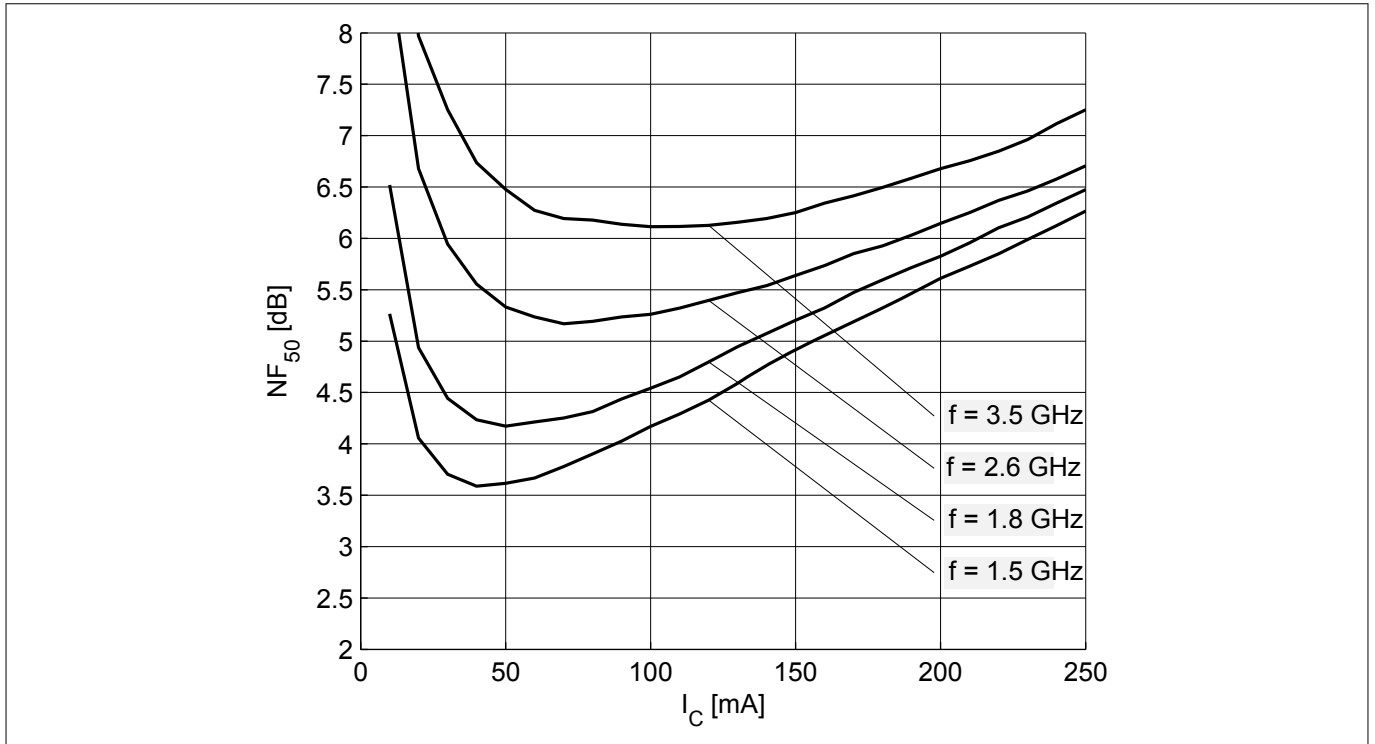

Figure 16 Noise Figure NF_{50} vs. I_C at $V_{CE} = 5\text{ V}$, $Z_S = 50\ \Omega$, $f = \text{Parameter}$

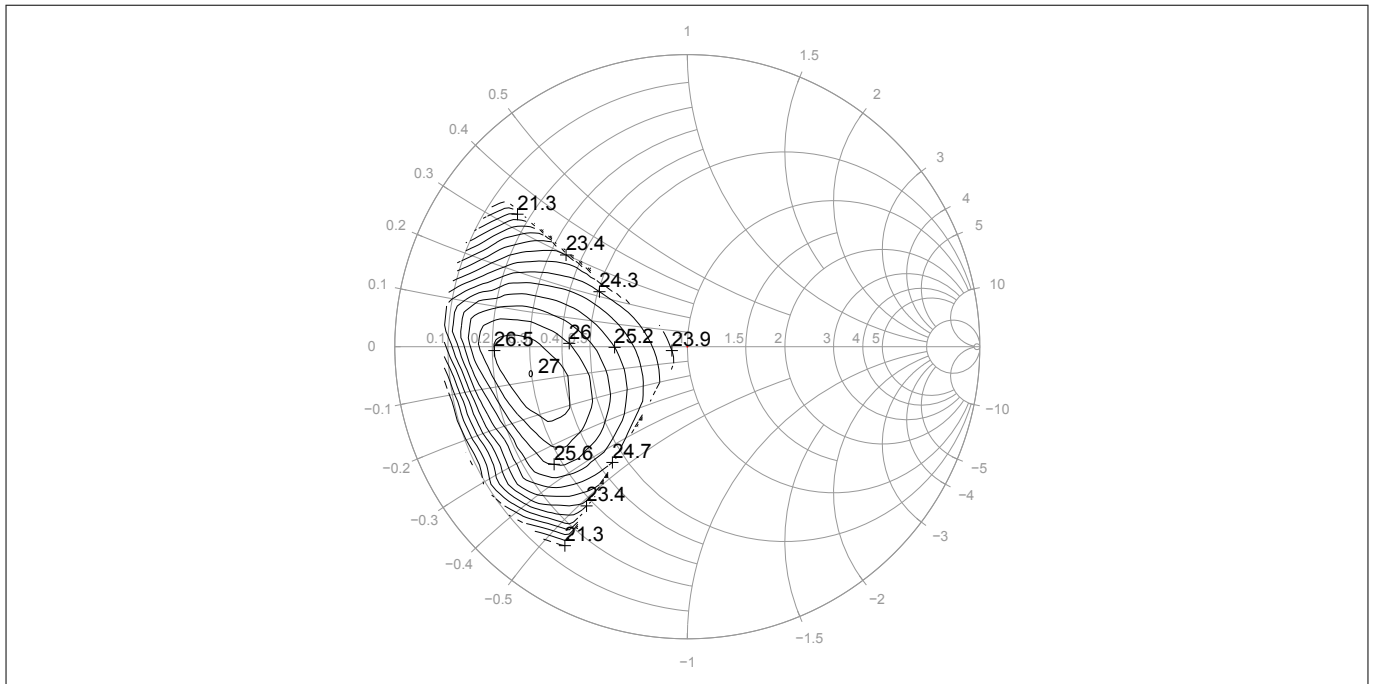

Figure 17 Load Pull Contour OP1dB [dBm] at $V_{CE} = 5\text{ V}$, $I_C = 250\text{ mA}$, $f = 0.9\text{ GHz}$, $Z_1 = Z_{opt}$

Electrical Performance in Test Fixture

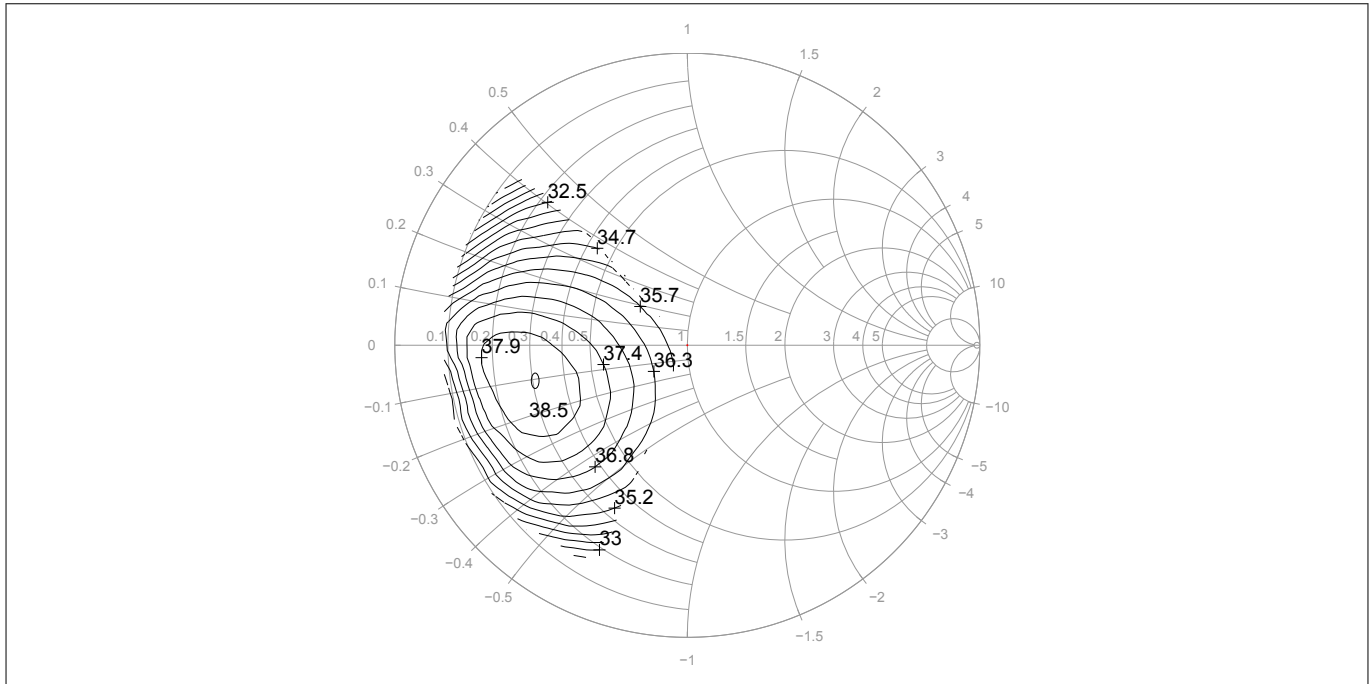

Figure 18 Load Pull Contour OIP3 [dBm] at $V_{CE} = 5\text{ V}$, $I_C = 250\text{ mA}$, $f = 0.9\text{ GHz}$, $Z_l = Z_{opt}$

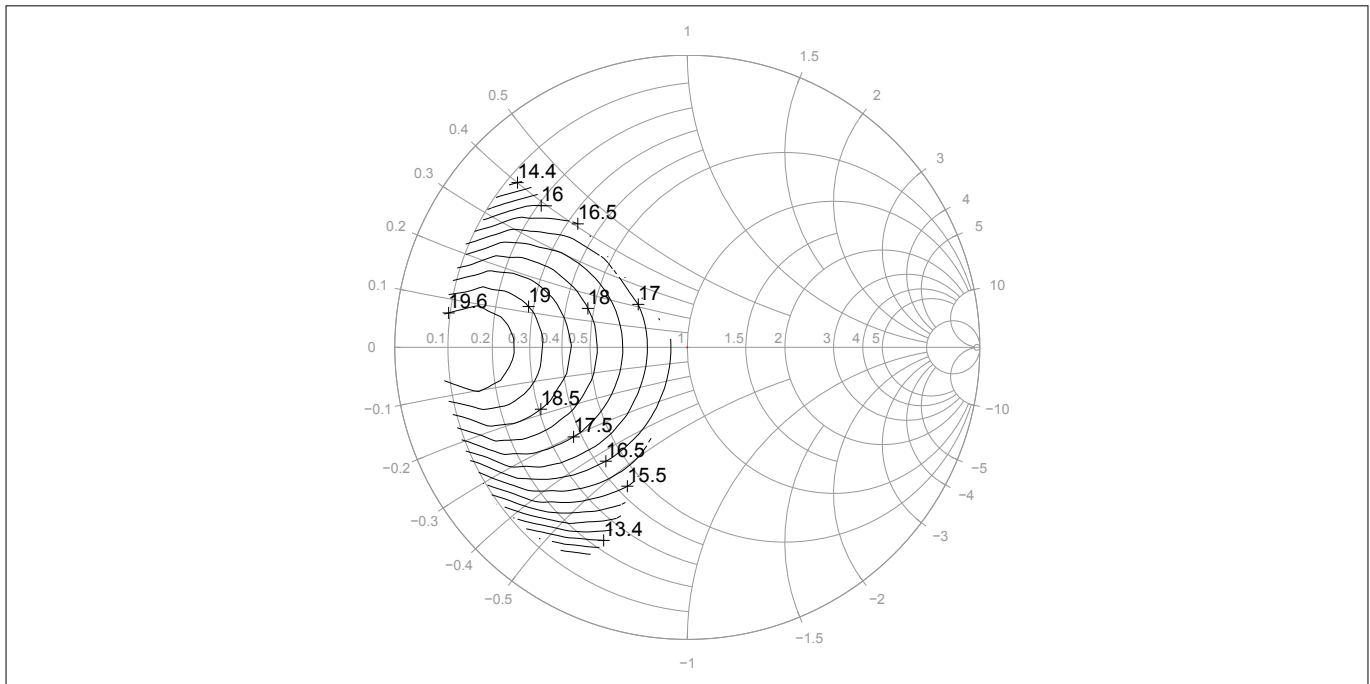

Figure 19 Load Pull Contour Gain G [dB] at $V_{CE} = 5\text{ V}$, $I_C = 250\text{ mA}$, $f = 0.9\text{ GHz}$, $Z_l = Z_{opt}$

Electrical Performance in Test Fixture

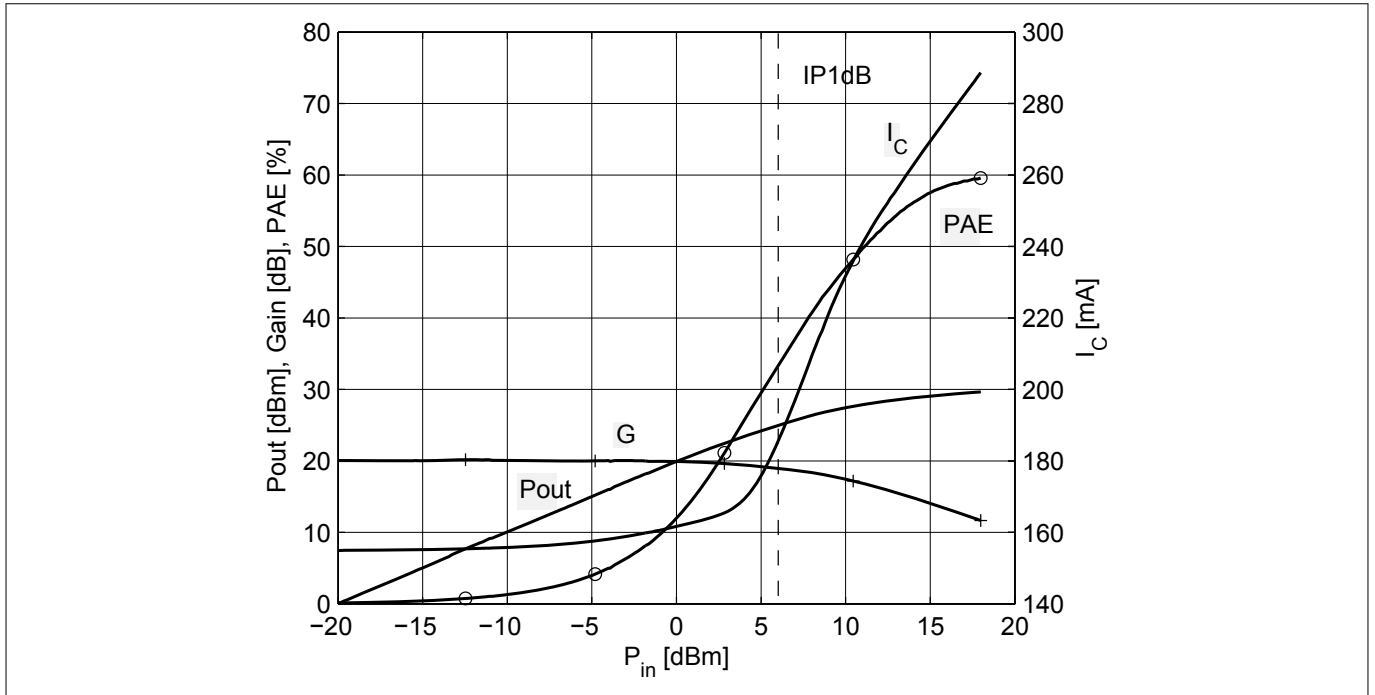

Figure 20 P_{out} , Gain, I_C , PAE vs. P_{in} at $V_{CE} = 5\text{ V}$, $I_{Cq} = 155\text{ mA}$, $f = 0.9\text{ GHz}$, $Z_l = Z_{opt}$

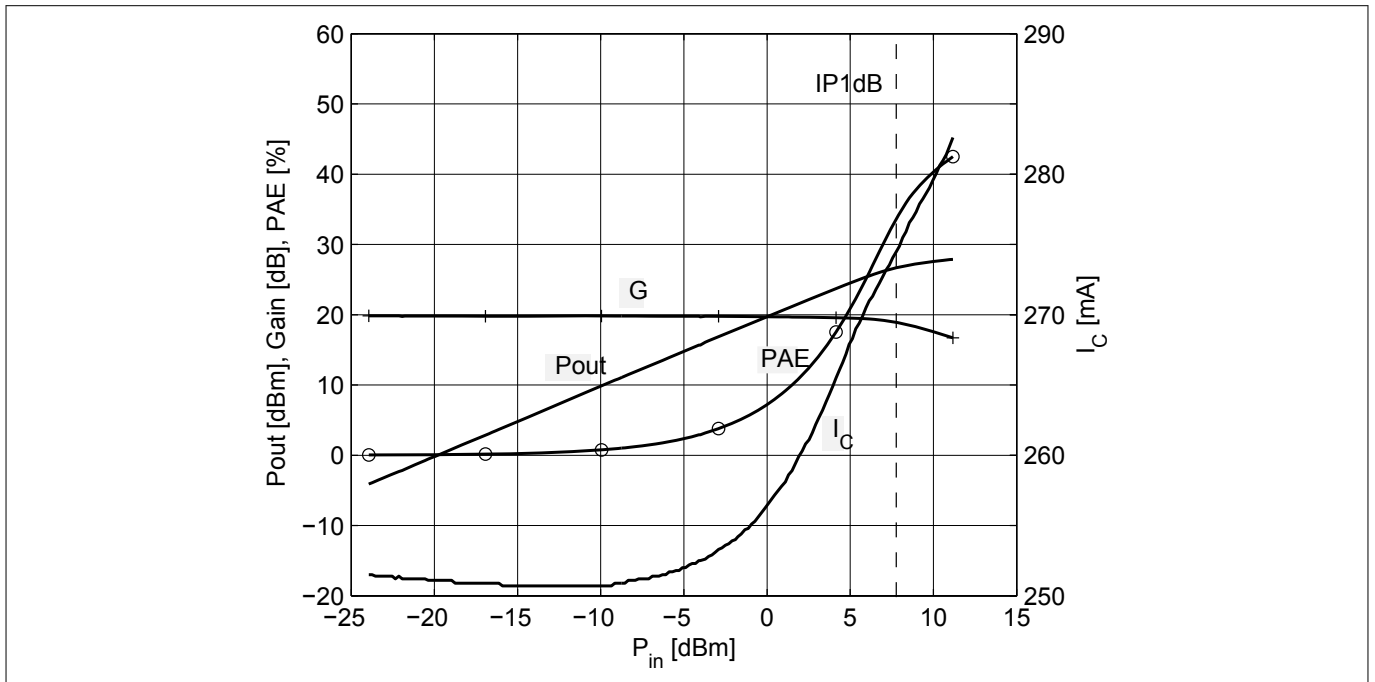

Figure 21 P_{out} , Gain, I_C , PAE vs. P_{in} at $V_{CE} = 5\text{ V}$, $I_{Cq} = 250\text{ mA}$, $f = 0.9\text{ GHz}$, $Z_l = Z_{opt}$

Electrical Performance in Test Fixture

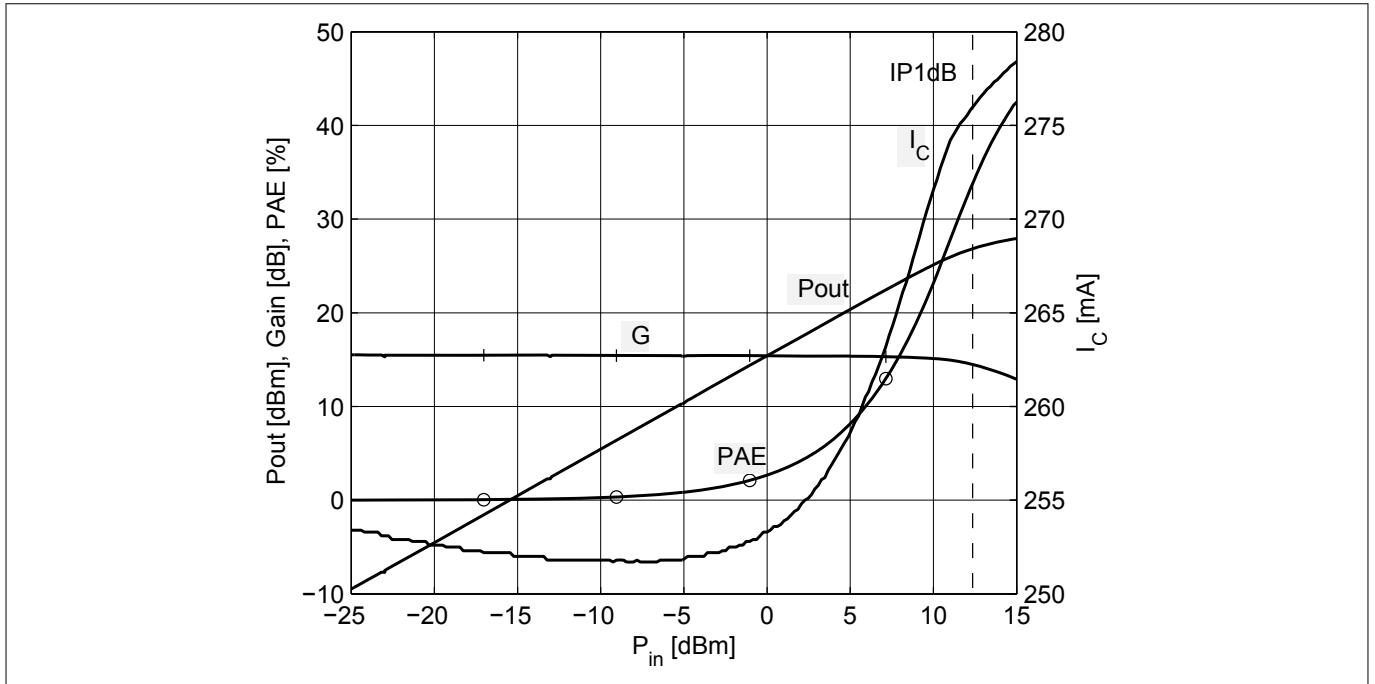

Figure 22 P_{out} , Gain, I_C , PAE vs. P_{in} at $V_{CE} = 5\text{ V}$, $I_{Cq} = 250\text{ mA}$, $f = 2.6\text{ GHz}$, $Z_l = Z_{opt}$

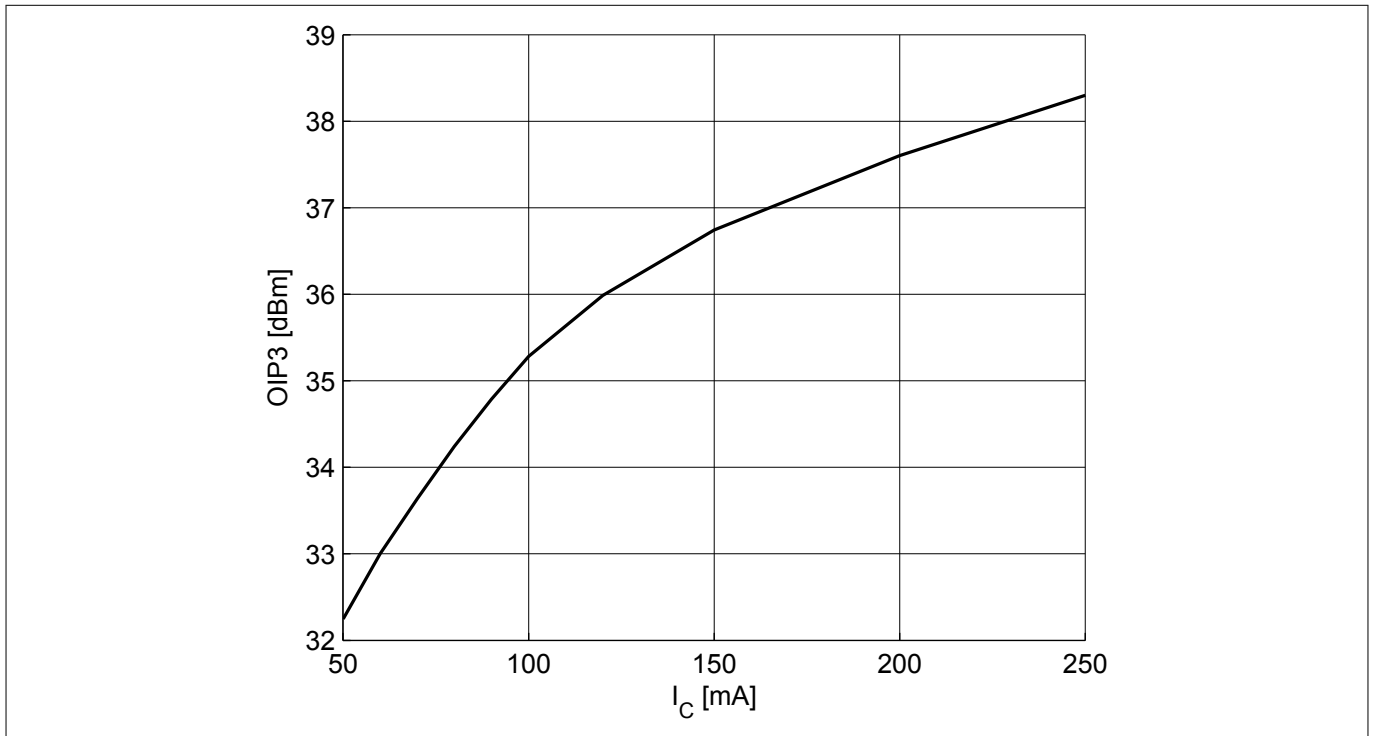

Figure 23 OIP3 vs. I_C at $V_{CE} = 5\text{ V}$, $f = 0.9\text{ GHz}$, $Z_L = Z_{Lopt}$

Note: The curves shown in this chapter have been generated using typical devices but shall not be understood as a guarantee that all devices have identical characteristic curves. $T_A = 25\text{ }^\circ\text{C}$.

5 Simulation Data

For the BFQ790 a large signal model exists. It is a VBIC model, which is an advancement of the SPICE Gummel-Poon model. It covers properties of a power transistor which are not known by the standard SPICE Gummel-Poon model, such as self-heating, quasi-saturation and voltage breakdown. The VBIC model can be used in standard simulation tools such as ADS and MWO as easily as the SPICE Gummel-Poon model. On the BFQ790 internet page the VBIC model is provided as a netlist. The model already contains the package parasitics and is ready to use for DC and high frequency simulations. Besides the DC characteristics all S-parameters in magnitude and phase, noise figure (including optimum source impedance and equivalent noise resistance), intermodulation and compression have been extracted.

On the BFQ790 internet page you also find the S-parameters (including noise parameters) for linear simulation. In any case please consult our website and download the latest versions before actually starting your design.

Package Information SOT89

6 Package Information SOT89

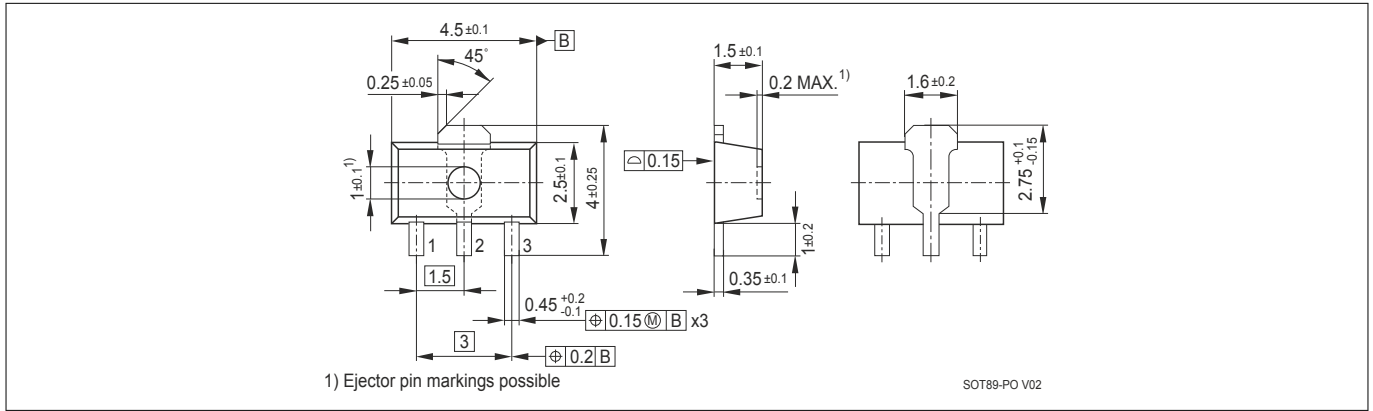

Figure 24 Package Outline (dimension in mm)

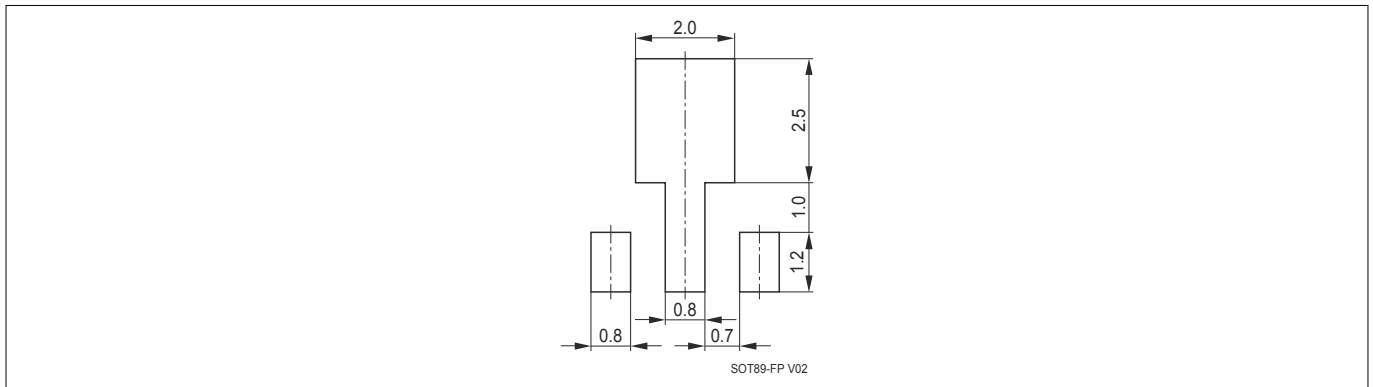

Figure 25 Package Footprint (dimension in mm)

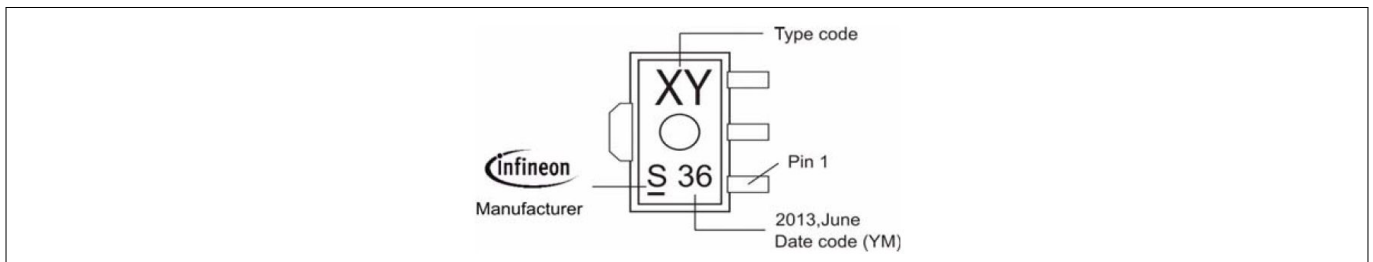

Figure 26 Marking Example (marking BFQ790: R3)

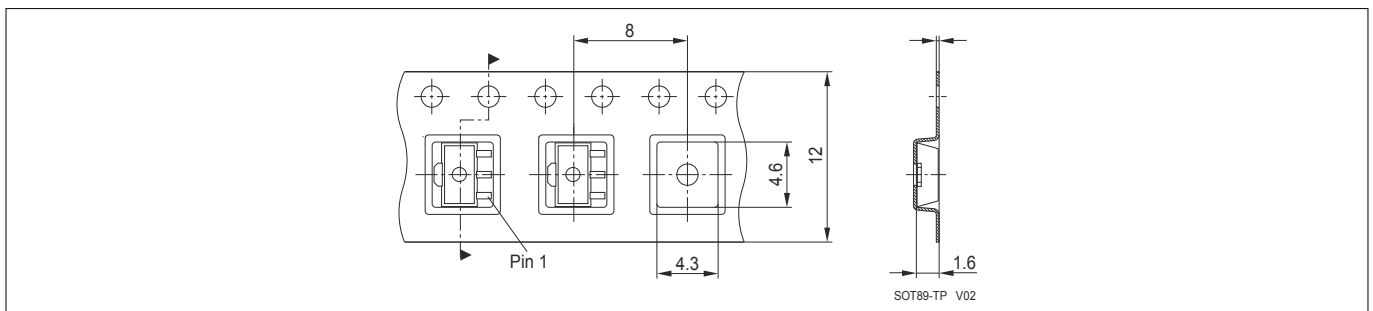

Figure 27 Tape Dimensions (dimension in mm)

Revision History

Revision History

Major changes since previous revision

Revision History

Reference	Description
Revision History: 2014-08-26, Revision 2.0	
	Preliminary datasheet based on measurements of engineering samples, replaces target datasheet.
	...

Trademarks of Infineon Technologies AG

μ HVIC™, μ IPM™, μ PFC™, AU-ConvertIR™, AURIX™, C166™, CanPAK™, CIPOS™, CIPURSE™, CoolDP™, CoolGaN™, COOLiR™, CoolMOS™, CoolSET™, CoolSiC™, DAVE™, DI-POL™, DirectFET™, DrBlade™, EasyPIM™, EconoBRIDGE™, EconoDUAL™, EconoPACK™, EconoPIM™, EiceDRIVER™, eupec™, FCOS™, GaNpowIR™, HEXFET™, HITFET™, HybridPACK™, iMOTION™, IRAM™, ISOFACE™, IsoPACK™, LEDriviR™, LITIX™, MIPAQ™, ModSTACK™, my-d™, NovalithIC™, OPTIGA™, OptiMOS™, ORIGA™, PowIRaudio™, PowIRstage™, PrimePACK™, PrimeSTACK™, PROFET™, PRO-SIL™, RASIC™, REAL3™, SmartLEWIS™, SOLID FLASH™, SPOC™, StrongIRFET™, SuplIRBuck™, TEMPFET™, TRENCHSTOP™, TriCore™, UHVIC™, XHP™, XMC™.

Trademarks Update 2015-12-22

Other Trademarks

All referenced product or service names and trademarks are the property of their respective owners.

Edition 2017-02-16

Published by
Infineon Technologies AG
81726 Munich, Germany

© 2017 Infineon Technologies AG
All Rights Reserved.

Do you have a question about any aspect of this document?

Email: erratum@infineon.com

Document reference
IFX-hws1468299808712

IMPORTANT NOTICE

The information given in this document shall in no event be regarded as a guarantee of conditions or characteristics ("Beschaffenhheitsgarantie").

With respect to any examples, hints or any typical values stated herein and/or any information regarding the application of the product, Infineon Technologies hereby disclaims any and all warranties and liabilities of any kind, including without limitation warranties of non-infringement of intellectual property rights of any third party.

In addition, any information given in this document is subject to customer's compliance with its obligations stated in this document and any applicable legal requirements, norms and standards concerning customer's products and any use of the product of Infineon Technologies in customer's applications.

The data contained in this document is exclusively intended for technically trained staff. It is the responsibility of customer's technical departments to evaluate the suitability of the product for the intended application and the completeness of the product information given in this document with respect to such application.

WARNINGS

Due to technical requirements products may contain dangerous substances. For information on the types in question please contact your nearest Infineon Technologies office.

Except as otherwise explicitly approved by Infineon Technologies in a written document signed by authorized representatives of Infineon Technologies, Infineon Technologies' products may not be used in any applications where a failure of the product or any consequences of the use thereof can reasonably be expected to result in personal injury

Mouser Electronics

Authorized Distributor

Click to View Pricing, Inventory, Delivery & Lifecycle Information:

[Infineon:](#)

[BFQ790H6327XTSA1](#)