

# BFP740F

## SiGe:C NPN RF bipolar transistor



### Product description

The BFP740F is a wideband NPN RF heterojunction bipolar transistor (HBT).



### Feature list

- Low noise figure  $NF_{min} = 1$  dB at 5.5 GHz, 3 V, 6 mA
- High gain  $G_{ms} = 21$  dB at 5.5 GHz, 3 V, 15 mA
- $OIP_3 = 24$  dBm at 5.5 GHz, 3 V, 15 mA

### Product validation

Qualified for industrial applications according to the relevant tests of JEDEC47/20/22.

### Potential applications

- Wireless communications: WLAN, WiMax and UWB
- Satellite communication systems: GNSS navigation systems (GPS, GLONASS, BeiDou, Galileo), satellite radio (SDARs, DAB) and C-band LNB
- Multimedia applications such as portable TV, CATV and FM radio
- ISM applications like RKE, AMR and Zigbee, as well as for emerging wireless applications

### Device information

**Table 1** Part information

| Product name / Ordering code | Package  | Pin configuration |       |       |       | Marking | Pieces / Reel |
|------------------------------|----------|-------------------|-------|-------|-------|---------|---------------|
| BFP740F / BFP740FH6327XTSA1  | TSFP-4-1 | 1 = B             | 2 = E | 3 = C | 4 = E | R7s     | 3000          |

**Attention:** ESD (Electrostatic discharge) sensitive device, observe handling precautions

## Table of contents

|          |  |    |
|----------|--|----|
|          | <b>Product description</b> .....             | 1  |
|          | <b>Feature list</b> .....                    | 1  |
|          | <b>Product validation</b> .....              | 1  |
|          | <b>Potential applications</b> .....          | 1  |
|          | <b>Device information</b> .....              | 1  |
|          | <b>Table of contents</b> .....               | 2  |
| <b>1</b> | <b>Absolute maximum ratings</b> .....        | 3  |
| <b>2</b> | <b>Thermal characteristics</b> .....         | 4  |
| <b>3</b> | <b>Electrical characteristics</b> .....      | 5  |
| 3.1      | DC characteristics .....                     | 5  |
| 3.2      | General AC characteristics .....             | 5  |
| 3.3      | Frequency dependent AC characteristics ..... | 6  |
| 3.4      | Characteristic DC diagrams .....             | 10 |
| 3.5      | Characteristic AC diagrams .....             | 13 |
| <b>4</b> | <b>Package information TSFP-4-1</b> .....    | 20 |
|          | <b>Revision history</b> .....                | 21 |
|          | <b>Disclaimer</b> .....                      | 22 |

**Absolute maximum ratings**

**1 Absolute maximum ratings**

**Table 2 Absolute maximum ratings  $T_A = 25\text{ °C}$  (unless otherwise specified)**

| Parameter                             | Symbol    | Values |      | Unit | Note or test condition            |
|---------------------------------------|-----------|--------|------|------|-----------------------------------|
|                                       |           | Min.   | Max. |      |                                   |
| Collector emitter voltage             | $V_{CEO}$ | -      | 4.0  | V    | Open base                         |
|                                       |           |        | 3.5  |      | $T_A = -55\text{ °C}$ , open base |
| Collector emitter voltage             | $V_{CES}$ |        | 13   |      | E-B short circuited               |
| Collector base voltage                | $V_{CBO}$ |        | 13   |      | Open emitter                      |
| Emitter base voltage                  | $V_{EBO}$ |        | 1.2  |      | Open collector                    |
| Base current                          | $I_B$     |        | 4    | mA   | -                                 |
| Collector current                     | $I_C$     |        | 45   |      |                                   |
| Total power dissipation <sup>1)</sup> | $P_{tot}$ |        | 160  | mW   | $T_S \leq 102\text{ °C}$          |
| Junction temperature                  | $T_J$     |        | 150  | °C   | -                                 |
| Storage temperature                   | $T_{Stg}$ | -55    |      |      |                                   |

**Attention:** *Stresses above the max. values listed here may cause permanent damage to the device. Exposure to absolute maximum rating conditions for extended periods may affect device reliability. Exceeding only one of these values may cause irreversible damage to the integrated circuit.*

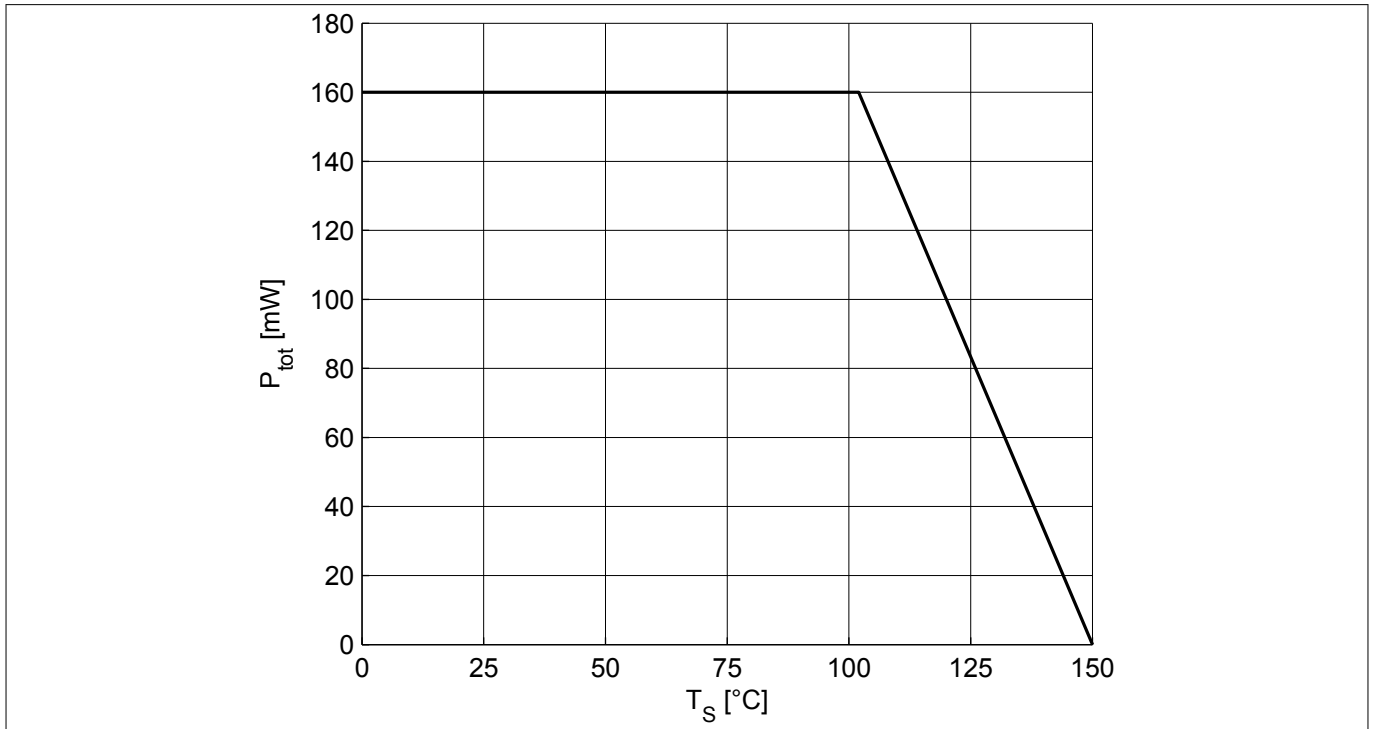
<sup>1</sup>  $T_S$  is the soldering point temperature.  $T_S$  is measured on the emitter lead at the soldering point of the PCB.

Thermal characteristics

## 2 Thermal characteristics

**Table 3 Thermal resistance**

| Parameter                  | Symbol     | Values |      |      | Unit | Note or test condition |
|----------------------------|------------|--------|------|------|------|------------------------|
|                            |            | Min.   | Typ. | Max. |      |                        |
| Junction - soldering point | $R_{thJS}$ | -      | 300  | -    | K/W  | -                      |



**Figure 1 Total power dissipation  $P_{tot} = f(T_S)$**

**Electrical characteristics**

**3 Electrical characteristics**

**3.1 DC characteristics**

**Table 4 DC characteristics at  $T_A = 25\text{ °C}$**

| Parameter                           | Symbol        | Values |      |                   | Unit | Note or test condition   |
|-------------------------------------|---------------|--------|------|-------------------|------|--|
|                                     |               | Min.   | Typ. | Max.              |      |  |
| Collector emitter breakdown voltage | $V_{(BR)CEO}$ | 4.0    | 4.7  | –                 | V    | $I_C = 1\text{ mA}$ , $I_B = 0$ , open base  |
| Collector emitter leakage current   | $I_{CES}$     | –      | 1    | 400 <sup>1)</sup> | nA   | $V_{CE} = 13\text{ V}$ , $V_{BE} = 0$<br>$V_{CE} = 5\text{ V}$ , $V_{BE} = 0$ ,<br>E-B short circuited |
| Collector base leakage current      | $I_{CBO}$     |        | 1    | 40 <sup>1)</sup>  |      |  |
| Emitter base leakage current        | $I_{EBO}$     |        | 1    | 40 <sup>1)</sup>  |      |  |
| DC current gain                     | $h_{FE}$      | 160    | 250  | 400               | –    | $V_{CE} = 3\text{ V}$ , $I_C = 25\text{ mA}$ , pulse measured  |

**3.2 General AC characteristics**

**Table 5 General AC characteristics at  $T_A = 25\text{ °C}$**

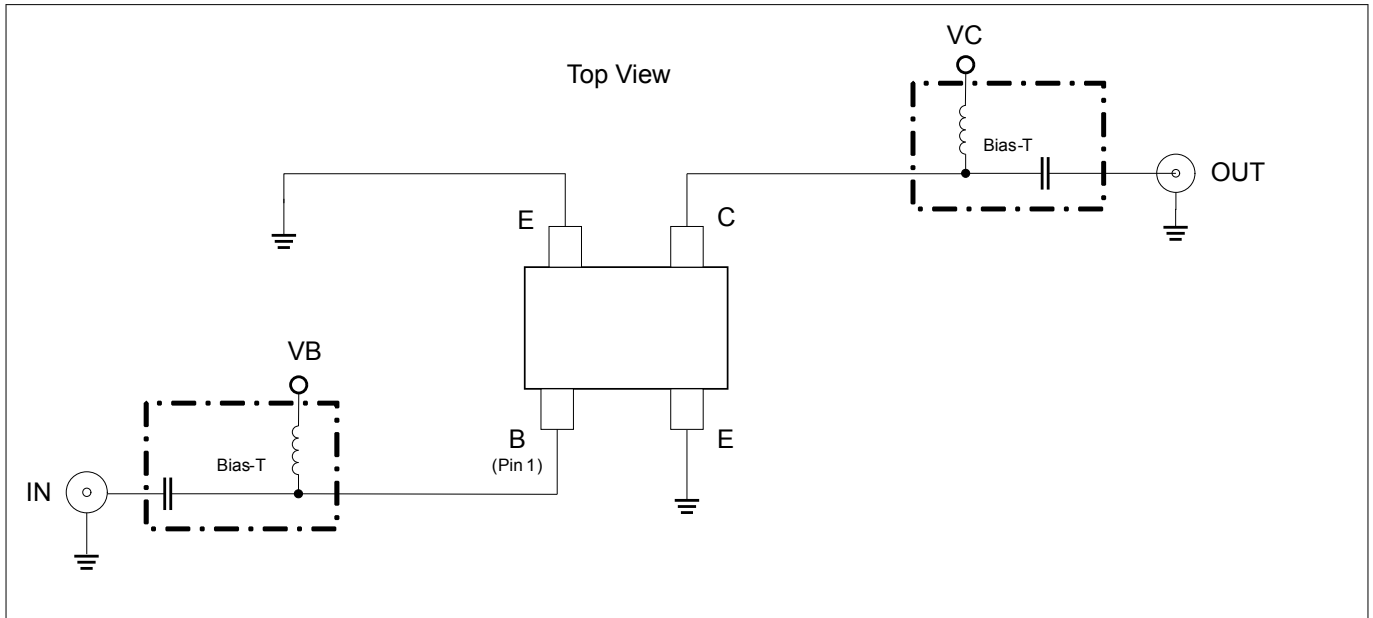
| Parameter                     | Symbol   | Values |      |      | Unit | Note or test condition   |
|-------------------------------|----------|--------|------|------|------|--|
|                               |          | Min.   | Typ. | Max. |      |  |
| Transition frequency          | $f_T$    | –      | 45   | –    | GHz  | $V_{CE} = 3\text{ V}$ , $I_C = 25\text{ mA}$ ,<br>$f = 2\text{ GHz}$                   |
| Collector base capacitance    | $C_{CB}$ |        | 0.08 | 0.12 | pF   | $V_{CB} = 3\text{ V}$ , $V_{BE} = 0$ ,<br>$f = 1\text{ MHz}$ ,<br>emitter grounded     |
| Collector emitter capacitance | $C_{CE}$ |        | 0.3  | –    |      |  |
| Emitter base capacitance      | $C_{EB}$ |        | 0.4  |      |      |  |
|                               |          |        |      |      |      | $V_{EB} = 0.5\text{ V}$ , $V_{CB} = 0$ ,<br>$f = 1\text{ MHz}$ ,<br>collector grounded |

<sup>1</sup> Maximum values not limited by the device but by the short cycle time of the 100% test

**Electrical characteristics**

**3.3 Frequency dependent AC characteristics**

Measurement setup is a test fixture with Bias-T's in a 50 Ω system,  $T_A = 25\text{ °C}$ .



**Figure 2**

**Table 6 AC characteristics,  $V_{CE} = 3\text{ V}$ ,  $f = 450\text{ MHz}$**

| Parameter  | Symbol                   | Values |             |      | Unit | Note or test condition                                |
|--|--------------------------|--------|-------------|------|------|---|
|  |                          | Min.   | Typ.        | Max. |      |   |
| Power gain   |                          | -      |             | -    | dB   | $I_C = 15\text{ mA}$                                  |
| <ul style="list-style-type: none"> <li>Maximum power gain</li> <li>Transducer gain</li> </ul>  | $G_{ms}$<br>$ S_{21} ^2$ |        | 32<br>30    |      |      |   |
| Noise figure   |                          |        |             |      | dB   | $I_C = 6\text{ mA}$                                   |
| <ul style="list-style-type: none"> <li>Minimum noise figure</li> <li>Associated gain</li> </ul>                                      | $NF_{min}$<br>$G_{ass}$  |        | 0.4<br>26.5 |      |      |   |
| Linearity  |                          |        |             |      | dBm  | $Z_S = Z_L = 50\text{ }\Omega$ , $I_C = 15\text{ mA}$ |
| <ul style="list-style-type: none"> <li>3rd order intercept point at output</li> <li>1 dB gain compression point at output</li> </ul> | $OIP_3$<br>$OP_{1dB}$    |        | 22.5<br>6.5 |      |      |   |

**Electrical characteristics**

**Table 7 AC characteristics,  $V_{CE} = 3\text{ V}$ ,  $f = 900\text{ MHz}$**

| Parameter                               | Symbol                   | Values |      |      | Unit | Note or test condition                          |
|---|--------------------------|--------|------|------|------|---|
|   |                          | Min.   | Typ. | Max. |      |   |
| Power gain                              | $G_{ms}$<br>$ S_{21} ^2$ | –      | 29   | –    | dB   | $I_C = 15\text{ mA}$                            |
| • Maximum power gain                    |                          |        |      |      |      |   |
| • Transducer gain                       |                          |        | 28   |      |      |   |
| Noise figure                            | $NF_{min}$<br>$G_{ass}$  |        | 0.45 | 25   |      | $I_C = 6\text{ mA}$                             |
| • Minimum noise figure                  |                          |        |      |      |      |   |
| • Associated gain                       |                          |        |      |      |      |   |
| Linearity                               | $OIP_3$<br>$OP_{1dB}$    |        | 23   | 8    | dBm  | $Z_S = Z_L = 50\ \Omega$ , $I_C = 15\text{ mA}$ |
| • 3rd order intercept point at output   |                          |        |      |      |      |   |
| • 1 dB gain compression point at output |                          |        |      |      |      |   |

**Table 8 AC characteristics,  $V_{CE} = 3\text{ V}$ ,  $f = 1.5\text{ GHz}$**

| Parameter                               | Symbol                   | Values |      |      | Unit | Note or test condition                          |
|---|--------------------------|--------|------|------|------|---|
|   |                          | Min.   | Typ. | Max. |      |   |
| Power gain                              | $G_{ms}$<br>$ S_{21} ^2$ | –      | 26.5 | –    | dB   | $I_C = 15\text{ mA}$                            |
| • Maximum power gain                    |                          |        |      |      |      |   |
| • Transducer gain                       |                          |        | 25.5 |      |      |   |
| Noise figure                            | $NF_{min}$<br>$G_{ass}$  |        | 0.5  | 23   |      | $I_C = 6\text{ mA}$                             |
| • Minimum noise figure                  |                          |        |      |      |      |   |
| • Associated gain                       |                          |        |      |      |      |   |
| Linearity                               | $OIP_3$<br>$OP_{1dB}$    |        | 22.5 | 8    | dBm  | $Z_S = Z_L = 50\ \Omega$ , $I_C = 15\text{ mA}$ |
| • 3rd order intercept point at output   |                          |        |      |      |      |   |
| • 1 dB gain compression point at output |                          |        |      |      |      |   |

**Table 9 AC characteristics,  $V_{CE} = 3\text{ V}$ ,  $f = 1.9\text{ GHz}$**

| Parameter                               | Symbol                   | Values |      |      | Unit | Note or test condition                          |
|---|--------------------------|--------|------|------|------|---|
|   |                          | Min.   | Typ. | Max. |      |   |
| Power gain                              | $G_{ms}$<br>$ S_{21} ^2$ | –      | 25.5 | –    | dB   | $I_C = 15\text{ mA}$                            |
| • Maximum power gain                    |                          |        |      |      |      |   |
| • Transducer gain                       |                          |        | 24   |      |      |   |
| Noise figure                            | $NF_{min}$<br>$G_{ass}$  |        | 0.55 | 21.5 |      | $I_C = 6\text{ mA}$                             |
| • Minimum noise figure                  |                          |        |      |      |      |   |
| • Associated gain                       |                          |        |      |      |      |   |
| Linearity                               | $OIP_3$<br>$OP_{1dB}$    |        | 23.5 | 8    | dBm  | $Z_S = Z_L = 50\ \Omega$ , $I_C = 15\text{ mA}$ |
| • 3rd order intercept point at output   |                          |        |      |      |      |   |
| • 1 dB gain compression point at output |                          |        |      |      |      |   |

**Electrical characteristics**

**Table 10 AC characteristics,  $V_{CE} = 3\text{ V}$ ,  $f = 2.4\text{ GHz}$**

| Parameter  | Symbol                   | Values |      |      | Unit | Note or test condition                          |
|--|--------------------------|--------|------|------|------|---|
|  |                          | Min.   | Typ. | Max. |      |   |
| Power gain   | $G_{ms}$<br>$ S_{21} ^2$ | -      | 24.5 | -    | dB   | $I_C = 15\text{ mA}$                            |
| <ul style="list-style-type: none"> <li>Maximum power gain</li> <li>Transducer gain</li> </ul>  |                          |        | 22   |      |      |   |
| Noise figure   | $NF_{min}$<br>$G_{ass}$  |        | 0.6  |      |      | $I_C = 6\text{ mA}$                             |
| <ul style="list-style-type: none"> <li>Minimum noise figure</li> <li>Associated gain</li> </ul>                                      |                          |        | 20   |      |      |   |
| Linearity  | $OIP_3$<br>$OP_{1dB}$    |        | 24   |      | dBm  | $Z_S = Z_L = 50\ \Omega$ , $I_C = 15\text{ mA}$ |
| <ul style="list-style-type: none"> <li>3rd order intercept point at output</li> <li>1 dB gain compression point at output</li> </ul> |                          |        | 8    |      |      |   |

**Table 11 AC characteristics,  $V_{CE} = 3\text{ V}$ ,  $f = 3.5\text{ GHz}$**

| Parameter  | Symbol                   | Values |      |      | Unit | Note or test condition                          |
|--|--------------------------|--------|------|------|------|---|
|  |                          | Min.   | Typ. | Max. |      |   |
| Power gain   | $G_{ms}$<br>$ S_{21} ^2$ | -      | 23   | -    | dB   | $I_C = 15\text{ mA}$                            |
| <ul style="list-style-type: none"> <li>Maximum power gain</li> <li>Transducer gain</li> </ul>  |                          |        | 19   |      |      |   |
| Noise figure   | $NF_{min}$<br>$G_{ass}$  |        | 0.75 |      |      | $I_C = 6\text{ mA}$                             |
| <ul style="list-style-type: none"> <li>Minimum noise figure</li> <li>Associated gain</li> </ul>                                      |                          |        | 17.5 |      |      |   |
| Linearity  | $OIP_3$<br>$OP_{1dB}$    |        | 24.5 |      | dBm  | $Z_S = Z_L = 50\ \Omega$ , $I_C = 15\text{ mA}$ |
| <ul style="list-style-type: none"> <li>3rd order intercept point at output</li> <li>1 dB gain compression point at output</li> </ul> |                          |        | 8    |      |      |   |

**Table 12 AC characteristics,  $V_{CE} = 3\text{ V}$ ,  $f = 5.5\text{ GHz}$**

| Parameter  | Symbol                   | Values |      |      | Unit | Note or test condition                          |
|--|--------------------------|--------|------|------|------|---|
|  |                          | Min.   | Typ. | Max. |      |   |
| Power gain   | $G_{ms}$<br>$ S_{21} ^2$ | -      | 21   | -    | dB   | $I_C = 15\text{ mA}$                            |
| <ul style="list-style-type: none"> <li>Maximum power gain</li> <li>Transducer gain</li> </ul>  |                          |        | 15.5 |      |      |   |
| Noise figure   | $NF_{min}$<br>$G_{ass}$  |        | 0.8  |      |      | $I_C = 6\text{ mA}$                             |
| <ul style="list-style-type: none"> <li>Minimum noise figure</li> <li>Associated gain</li> </ul>                                      |                          |        | 14   |      |      |   |
| Linearity  | $OIP_3$<br>$OP_{1dB}$    |        | 24   |      | dBm  | $Z_S = Z_L = 50\ \Omega$ , $I_C = 15\text{ mA}$ |
| <ul style="list-style-type: none"> <li>3rd order intercept point at output</li> <li>1 dB gain compression point at output</li> </ul> |                          |        | 8    |      |      |   |



**Electrical characteristics**

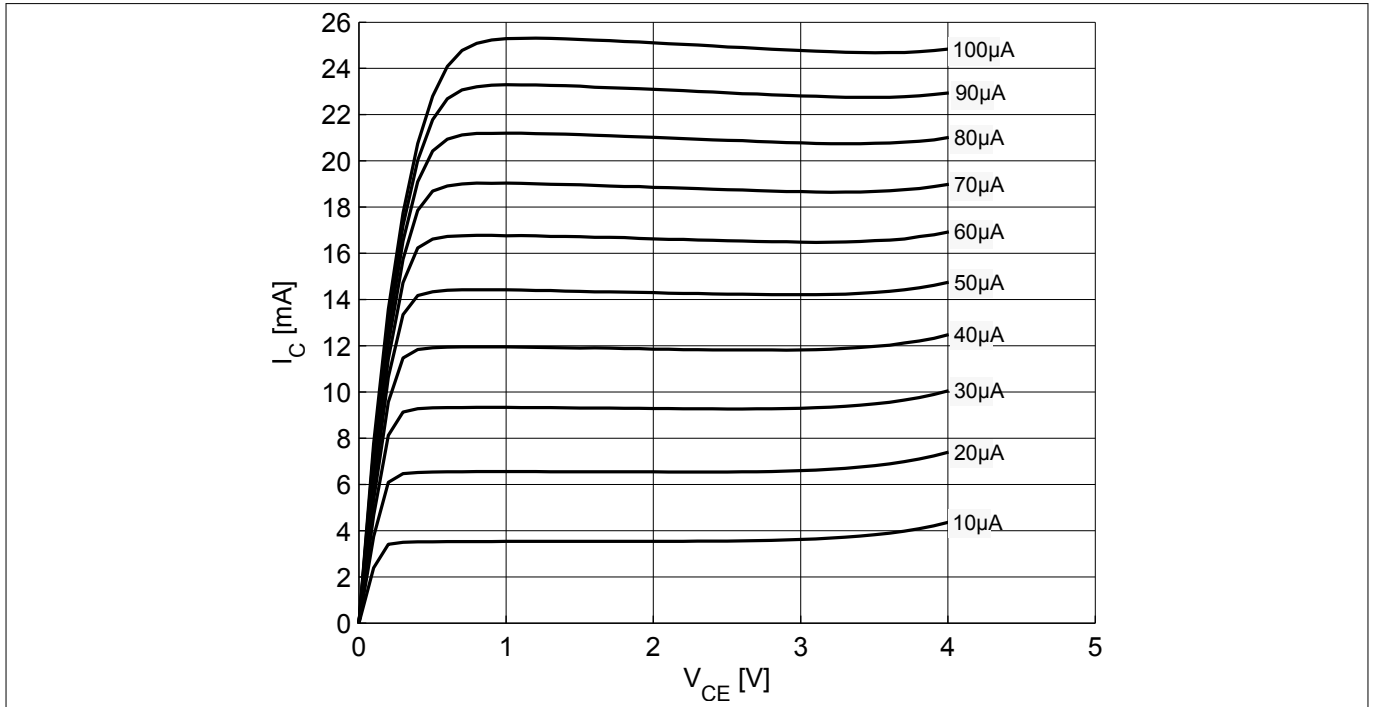
**Table 13 AC characteristics,  $V_{CE} = 3\text{ V}$ ,  $f = 10\text{ GHz}$**

| Parameter  | Symbol                   | Values    |         |      | Unit      | Note or test condition                          |    |                     |
|--|--------------------------|-----------|---------|------|-----------|---|----|---------------------|
|  |                          | Min.      | Typ.    | Max. |           |   |    |                     |
| Power gain   |                          | -         |         | -    | dB        | $I_C = 15\text{ mA}$                            |    |                     |
| <ul style="list-style-type: none"> <li>Maximum power gain</li> <li>Transducer gain</li> </ul>  | $G_{ma}$<br>$ S_{21} ^2$ |           | 14<br>9 |      |           |   |    |                     |
| Noise figure   |                          |           | -       |      |           | -   | dB | $I_C = 6\text{ mA}$ |
| <ul style="list-style-type: none"> <li>Minimum noise figure</li> <li>Associated gain</li> </ul>                                      | $NF_{min}$<br>$G_{ass}$  |           |         |      | 1.5<br>10 |   |    |                     |
| Linearity  |                          |           |         |      | dBm       | $Z_S = Z_L = 50\ \Omega$ , $I_C = 15\text{ mA}$ |    |                     |
| <ul style="list-style-type: none"> <li>3rd order intercept point at output</li> <li>1 dB gain compression point at output</li> </ul> | $OIP_3$<br>$OP_{1dB}$    | 23.5<br>8 |         |      |           |   |    |                     |

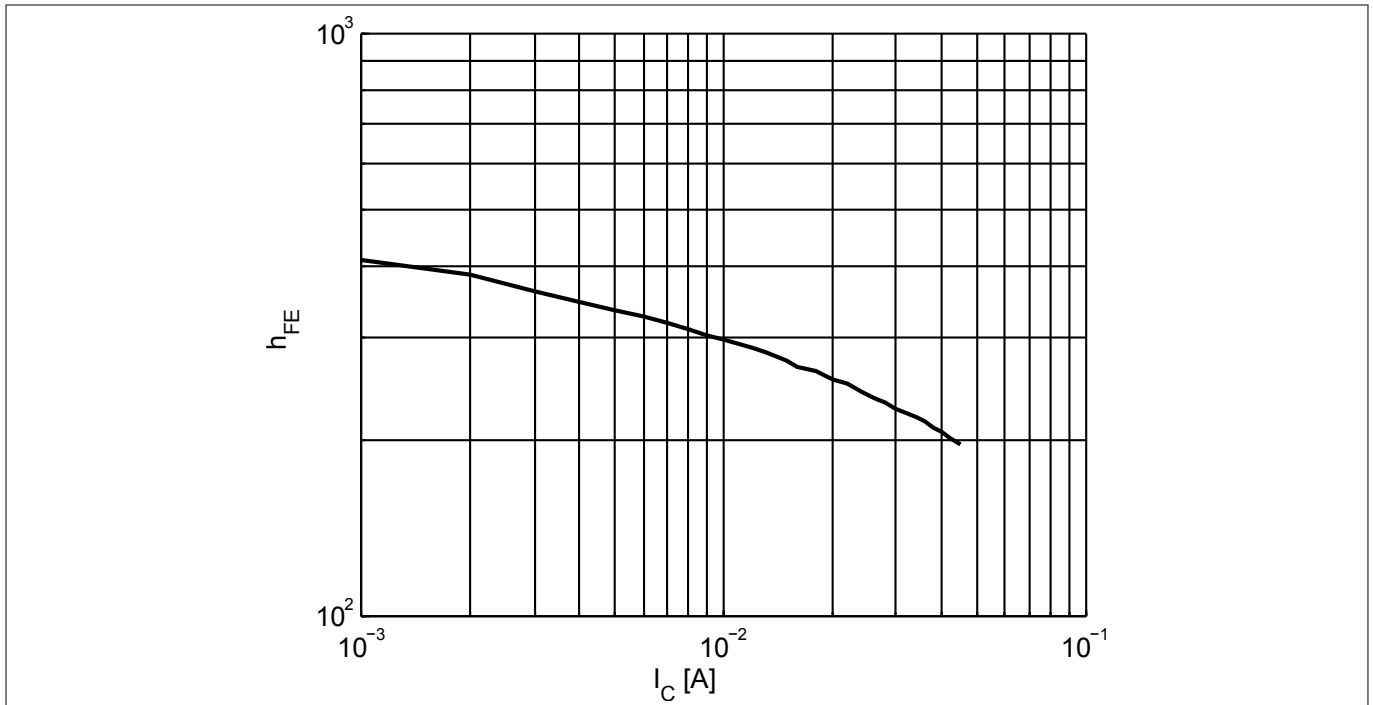
Note:  $G_{ms} = |S_{21}/S_{12}|$  for  $k < 1$ ;  $G_{ma} = |S_{21}/S_{12}|(k-(k^2-1)^{1/2})$  for  $k > 1$ . In order to get the  $NF_{min}$  values stated in this chapter, the test fixture losses have been subtracted from all measured results.  $OIP_3$  value depends on termination of all intermodulation frequency components. Termination used for this measurement is  $50\ \Omega$  from 0.2 MHz to 12 GHz.

**Electrical characteristics**

**3.4 Characteristic DC diagrams**

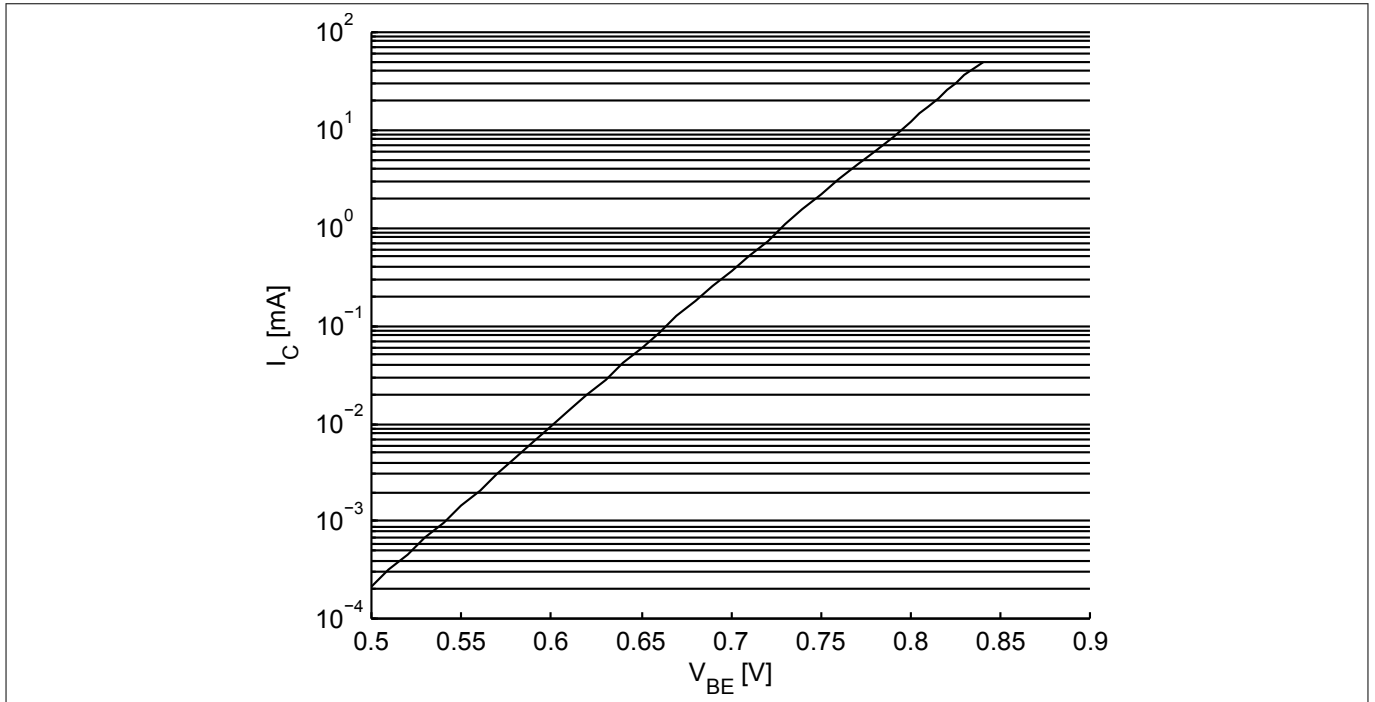


**Figure 3** Collector current vs. collector emitter voltage  $I_C = f(V_{CE})$ ,  $I_B = \text{parameter}$

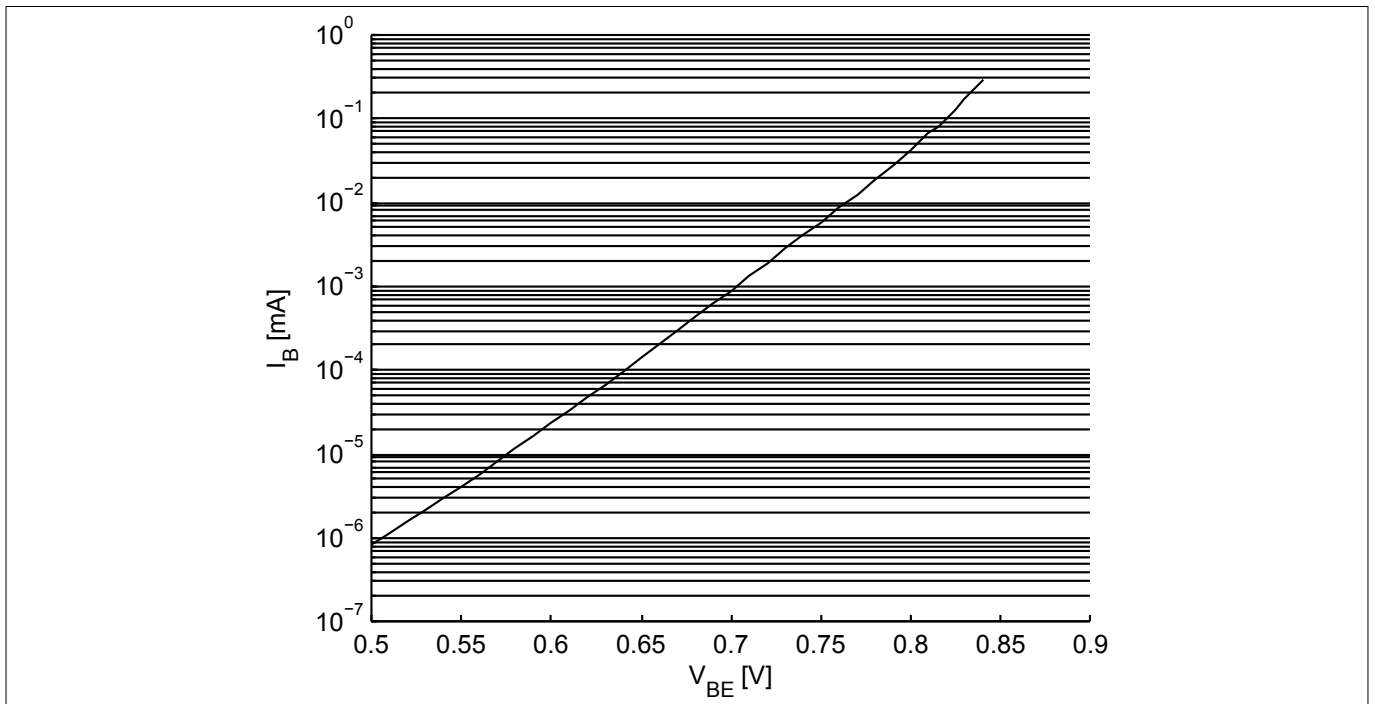


**Figure 4** DC current gain  $h_{FE} = f(I_C)$ ,  $V_{CE} = 3 \text{ V}$

**Electrical characteristics**

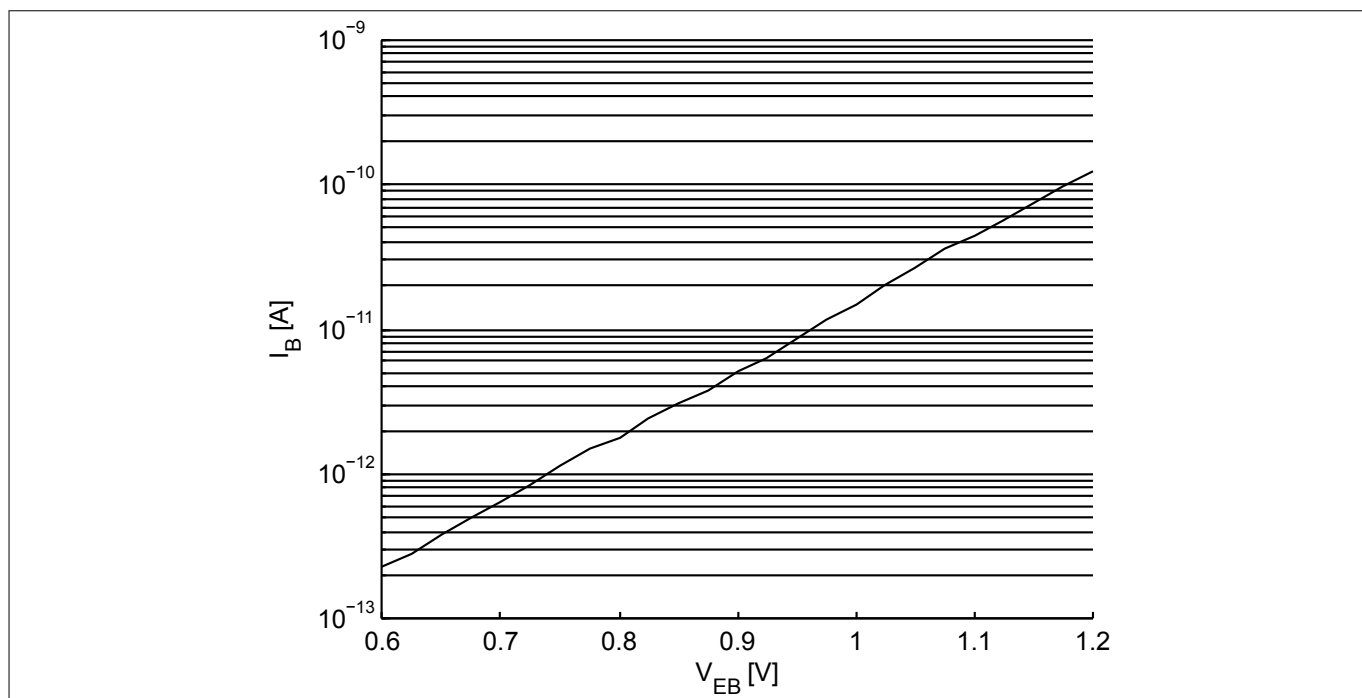


**Figure 5** Collector current vs. base emitter forward voltage  $I_C = f(V_{BE}), V_{CE} = 2\text{ V}$



**Figure 6** Base current vs. base emitter forward voltage  $I_B = f(V_{BE}), V_{CE} = 2\text{ V}$

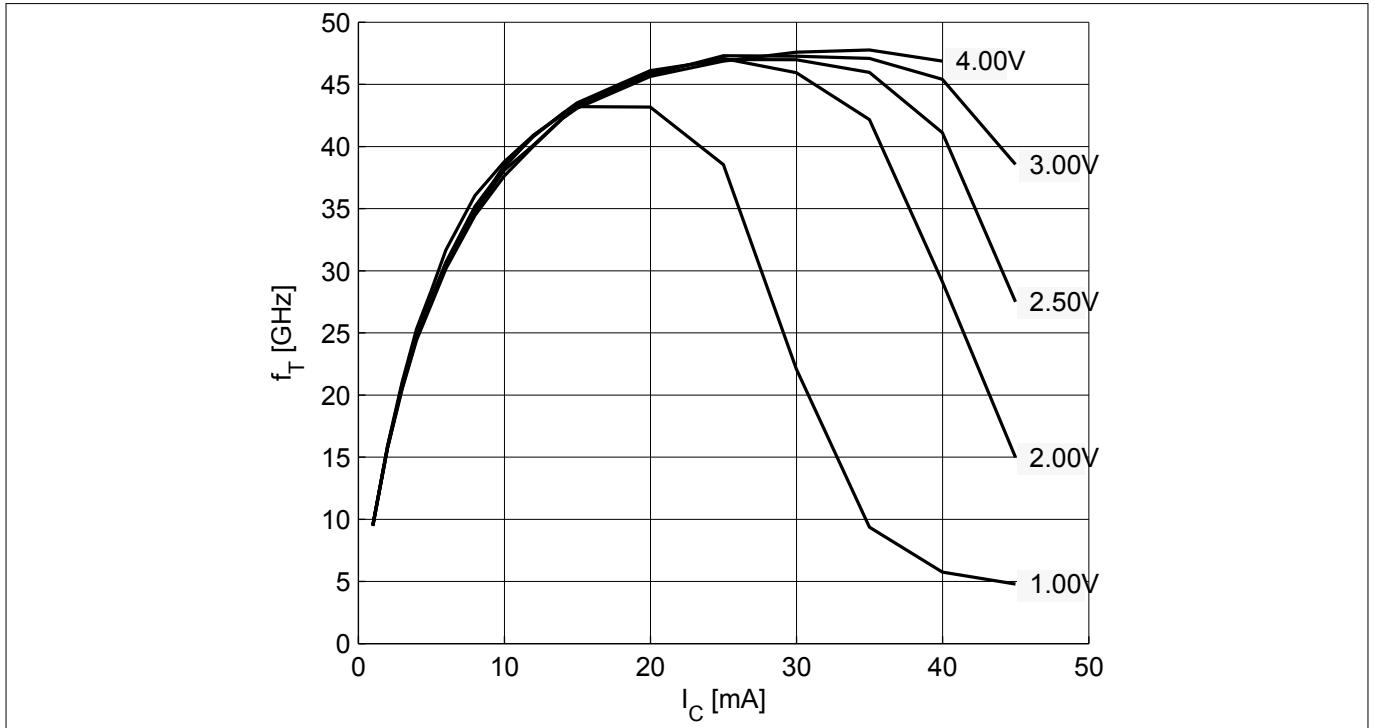
**Electrical characteristics**



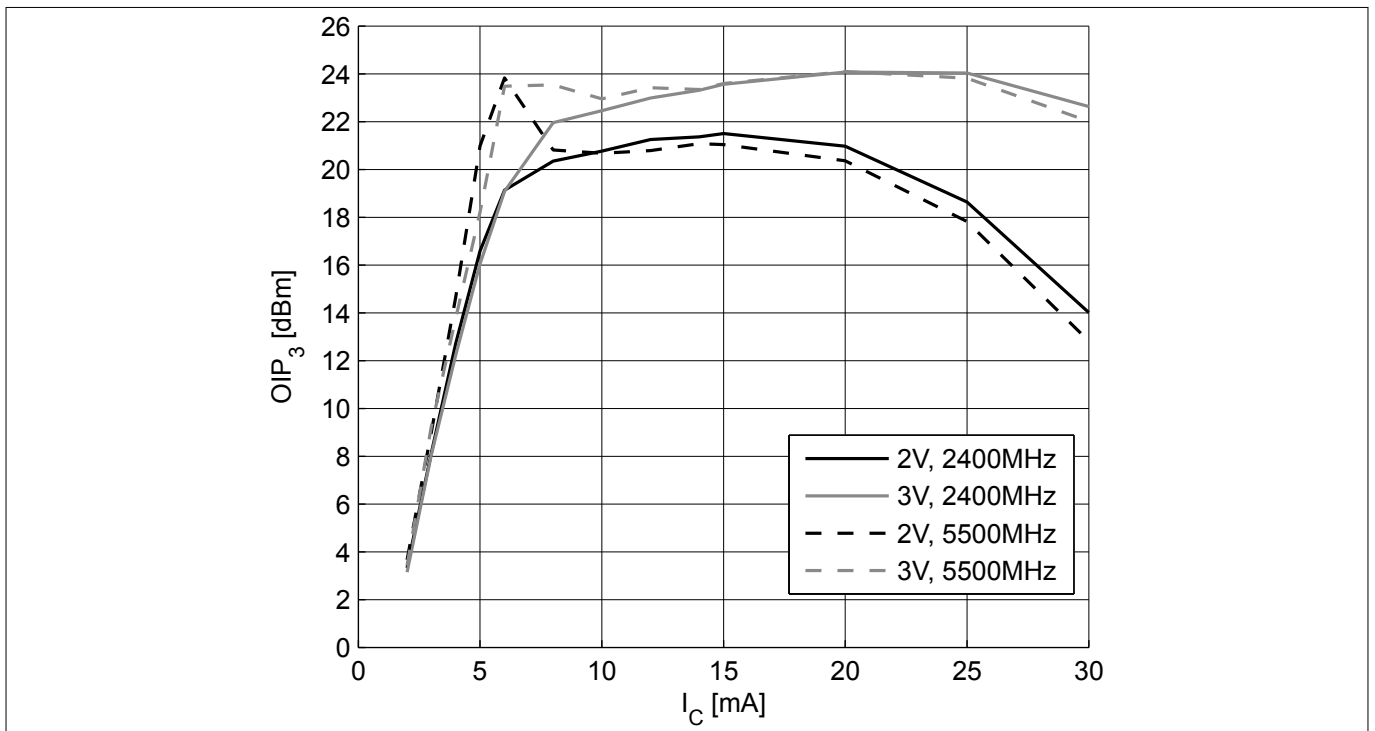
**Figure 7** Base current vs. base emitter reverse voltage  $I_B = f(V_{EB})$ ,  $V_{CE} = 2$  V

Electrical characteristics

**3.5 Characteristic AC diagrams**

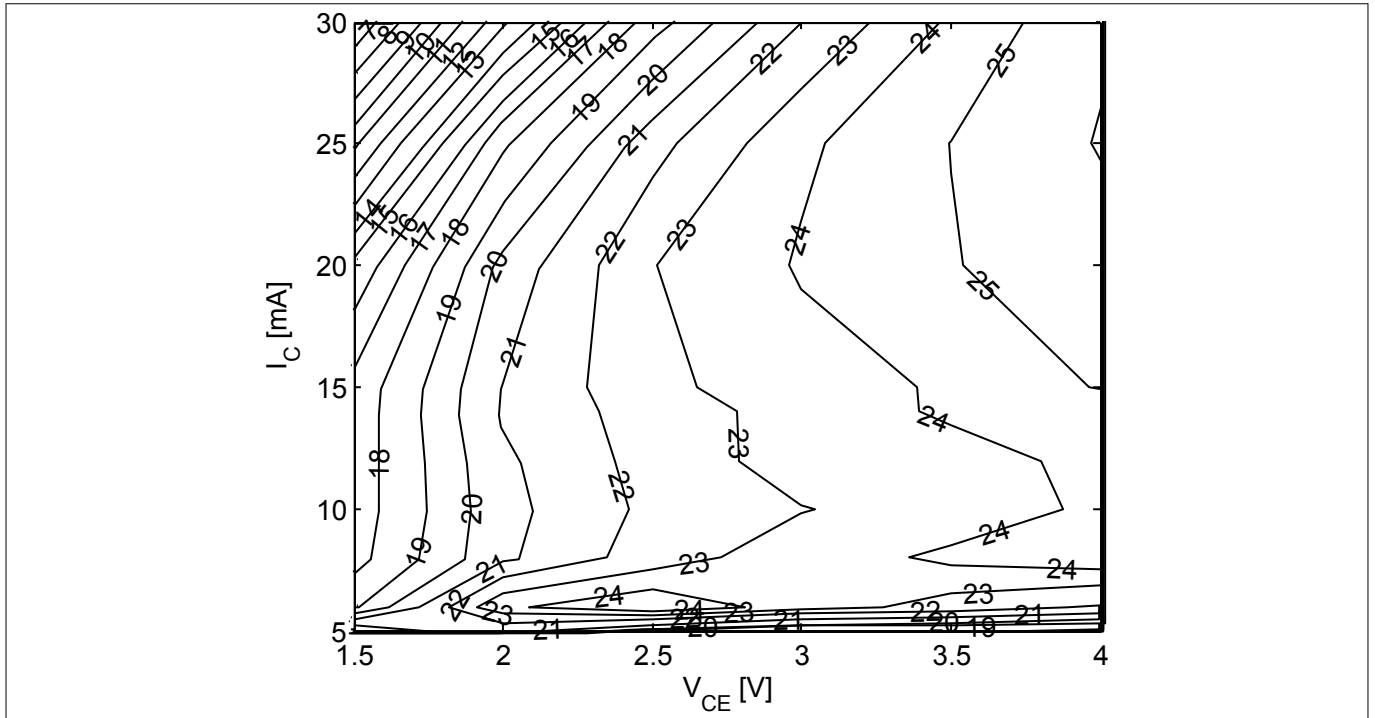


**Figure 8** Transition frequency  $f_T = f(I_C)$ ,  $f = 2$  GHz,  $V_{CE} =$  parameter

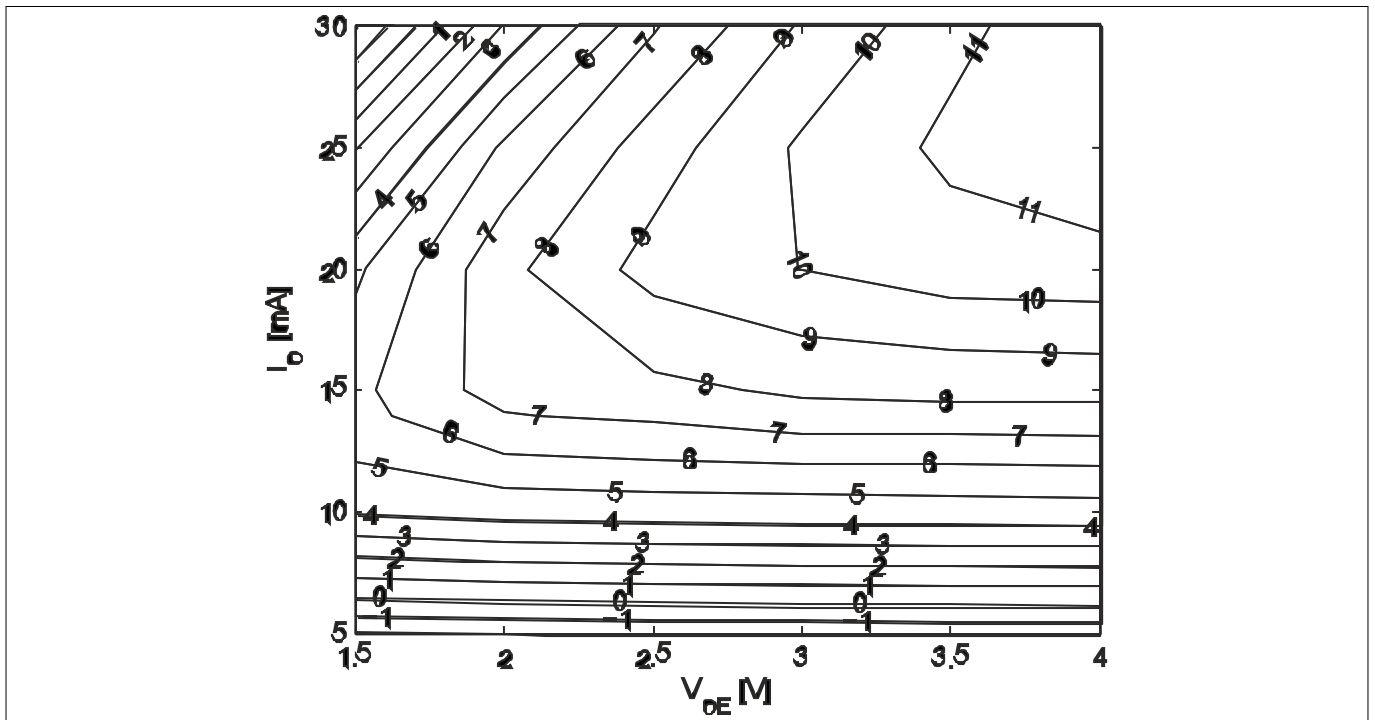


**Figure 9** 3rd order intercept point  $OIP_3 = f(I_C)$ ,  $Z_S = Z_L = 50 \Omega$ ,  $V_{CE}$ ,  $f =$  parameters

**Electrical characteristics**

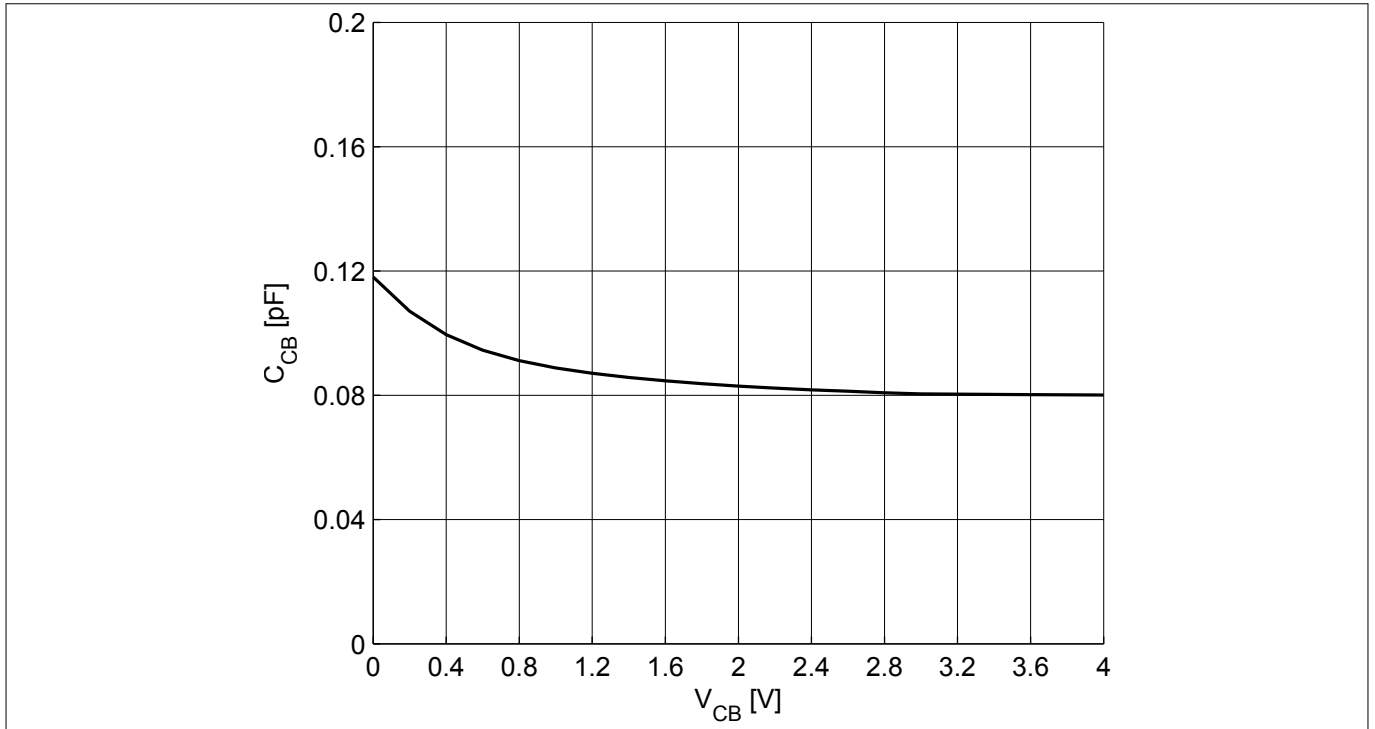


**Figure 10** 3rd order intercept point at output  $OIP_3$  [dBm] =  $f(I_C, V_{CE})$ ,  $Z_S = Z_L = 50 \Omega$ ,  $f = 5.5$  GHz

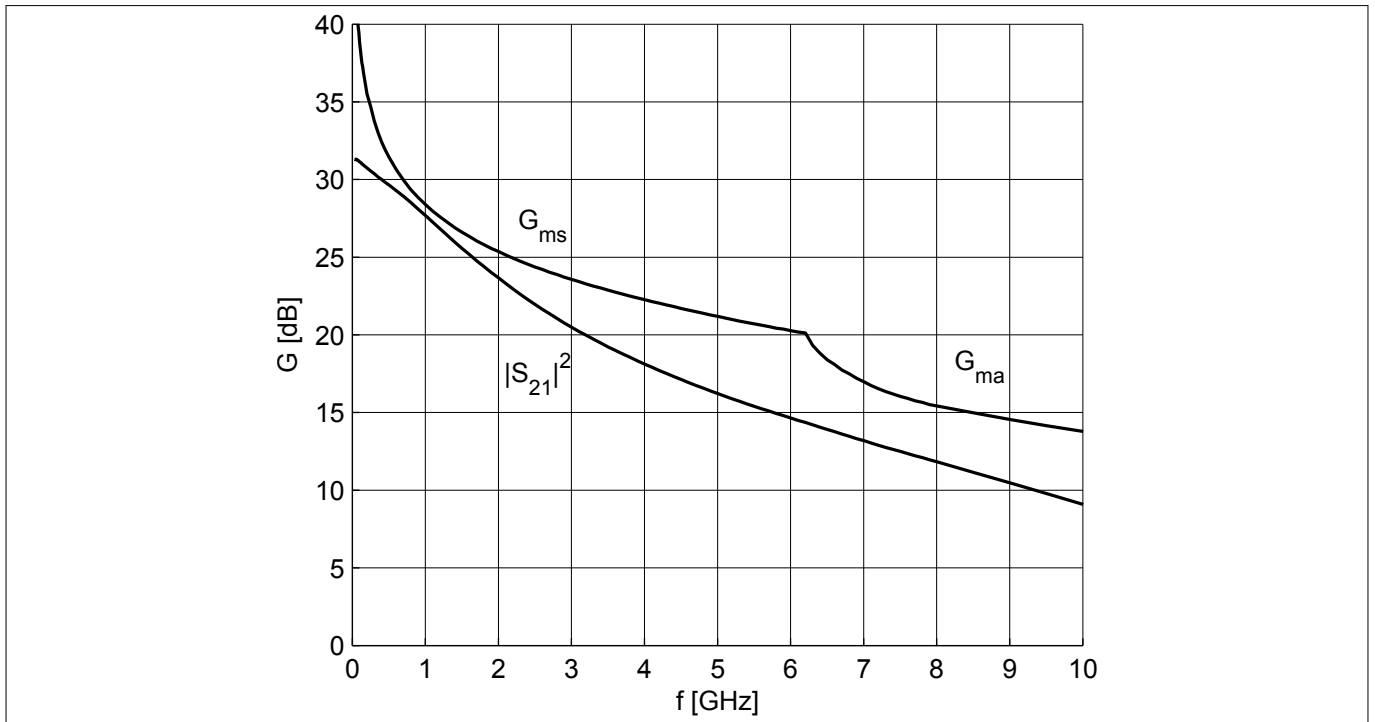


**Figure 11** Compression point at output  $OP_{1dB}$  [dBm] =  $f(I_C, V_{CE})$ ,  $Z_S = Z_L = 50 \Omega$ ,  $f = 5.5$  GHz

**Electrical characteristics**

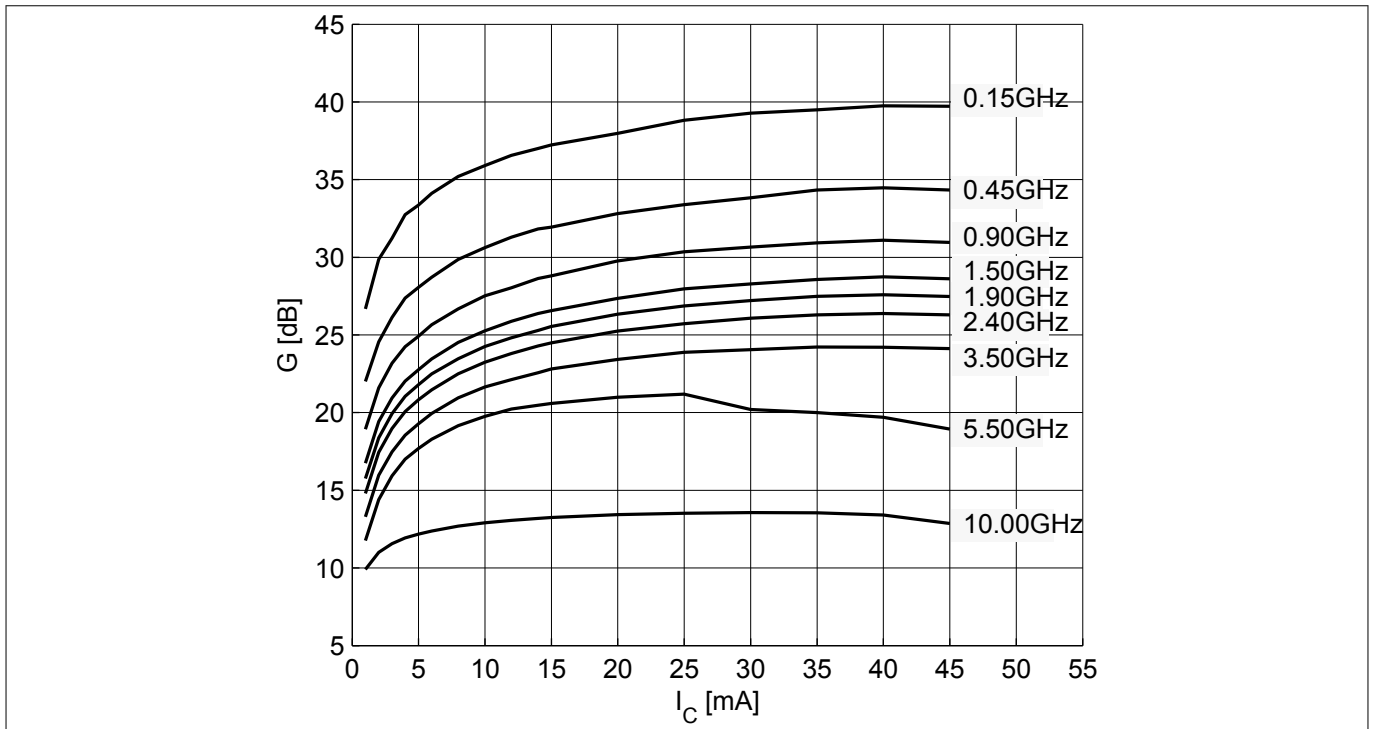


**Figure 12** Collector base capacitance  $C_{CB} = f(V_{CB})$ ,  $f = 1$  MHz

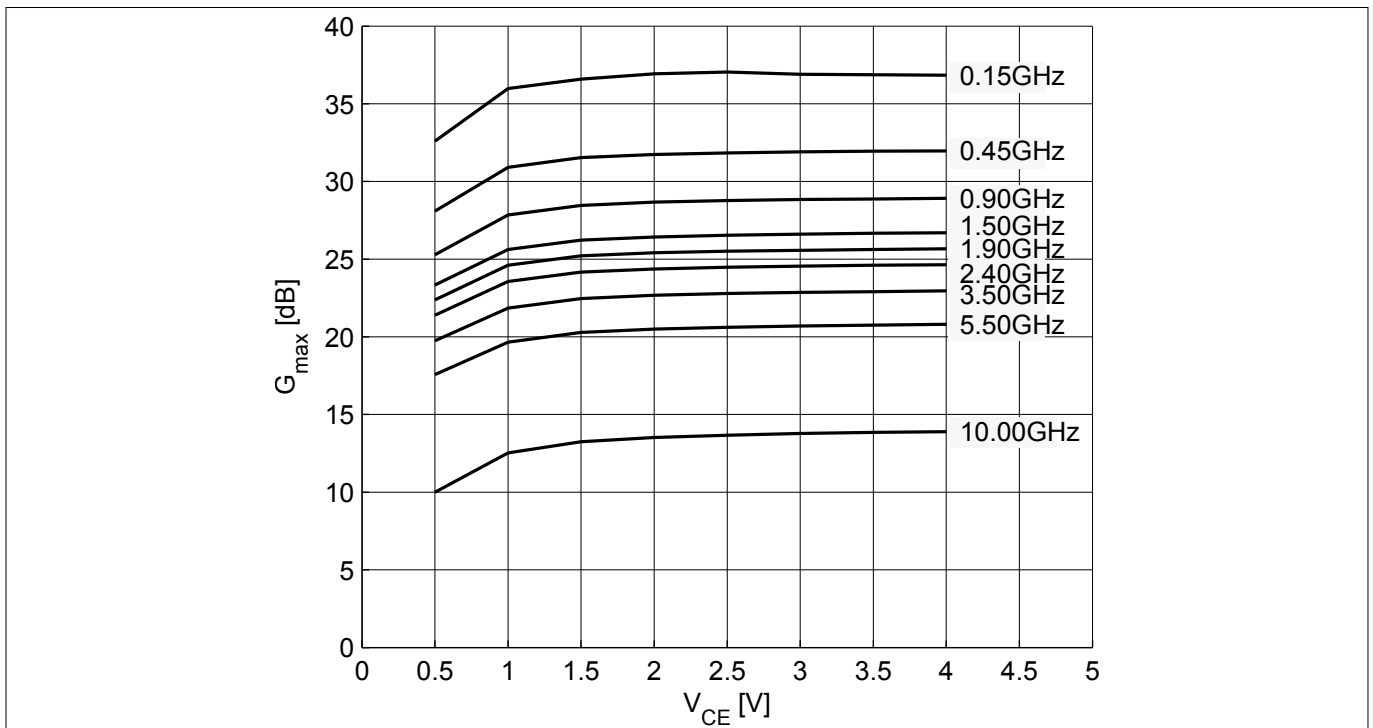


**Figure 13** Gain  $G_{ma}$ ,  $G_{ms}$ ,  $|S_{21}|^2 = f(f)$ ,  $V_{CE} = 3$  V,  $I_C = 15$  mA

**Electrical characteristics**



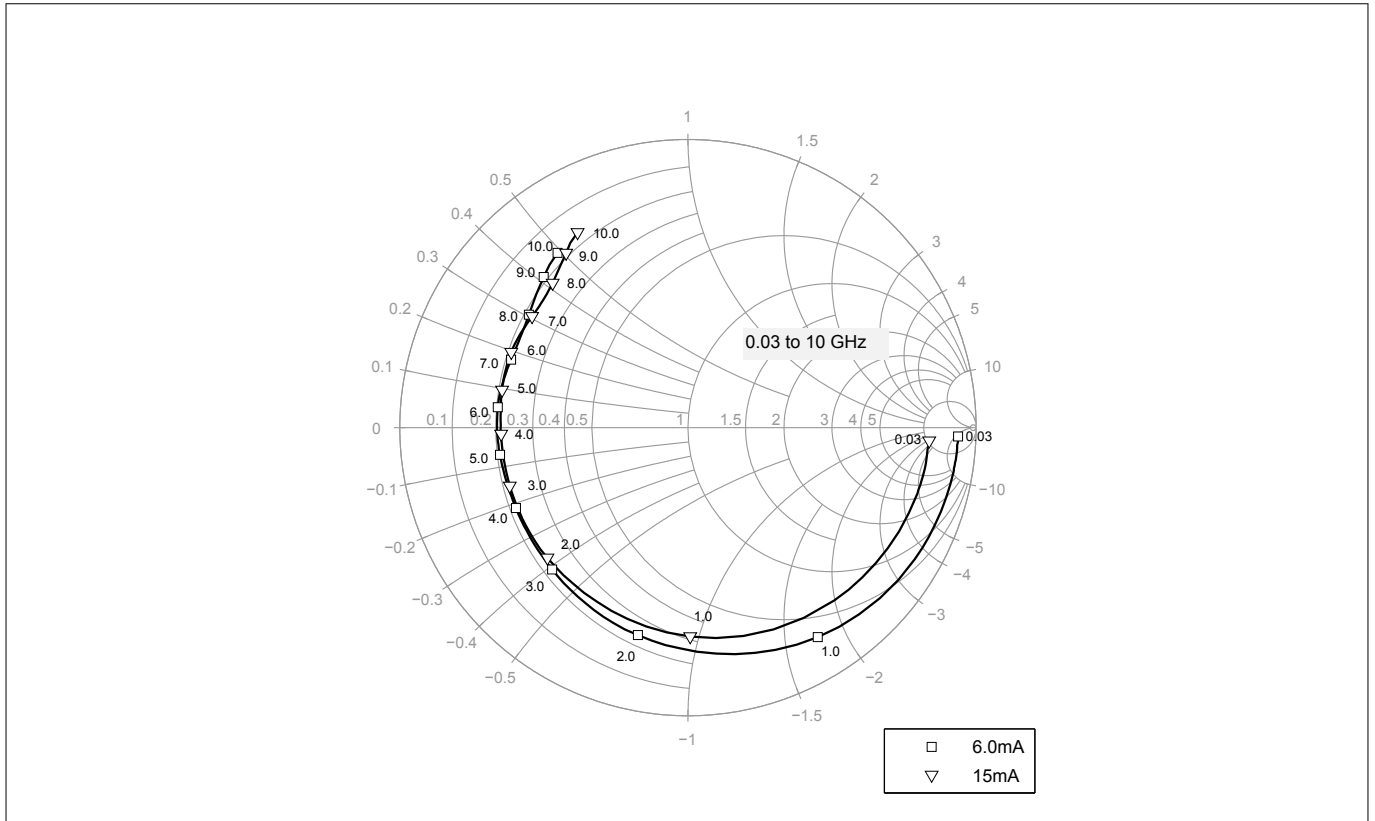
**Figure 14** Maximum power gain  $G_{\max} = f(I_C)$ ,  $V_{CE} = 3\text{ V}$ ,  $f = \text{parameter in GHz}$



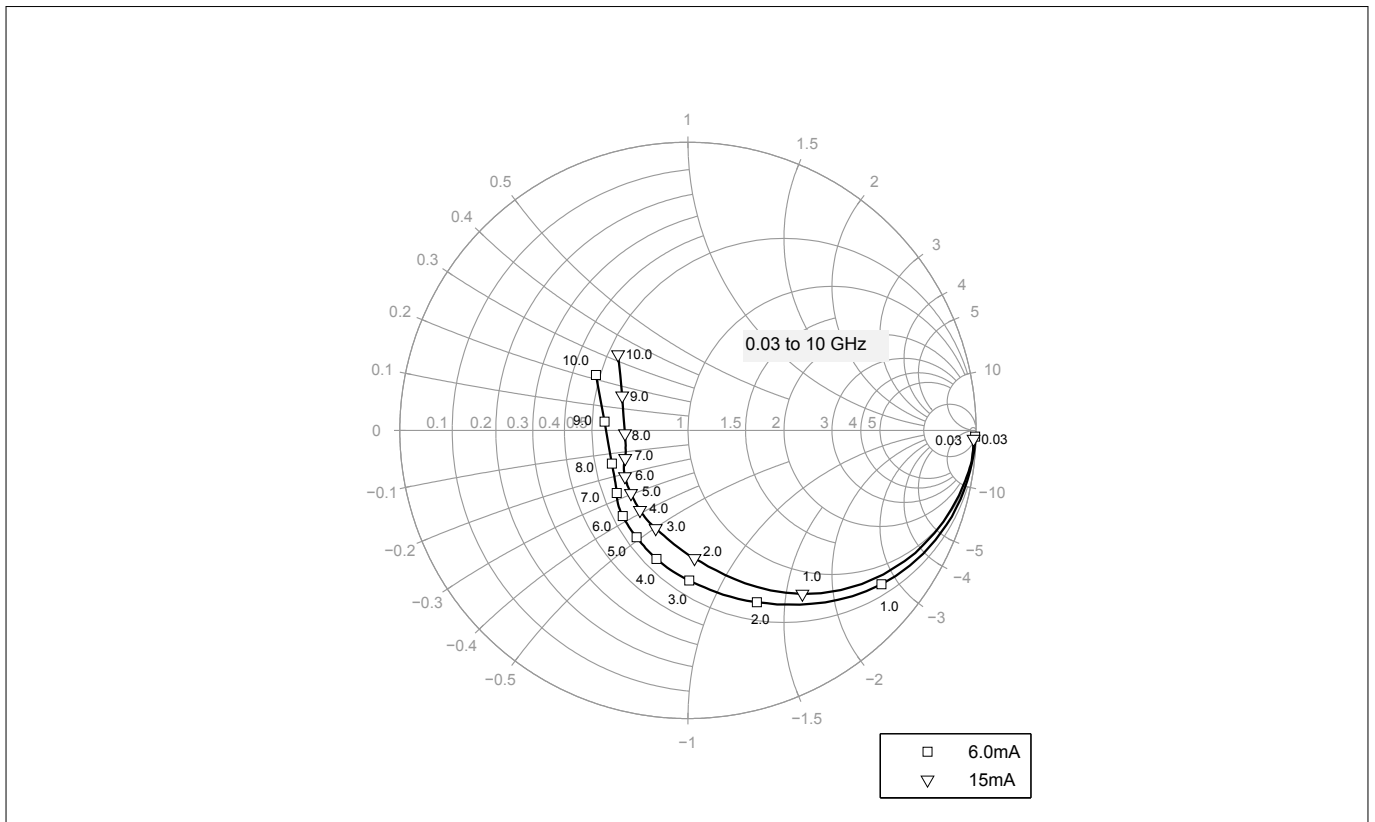
**Figure 15** Maximum power gain  $G_{\max} = f(V_{CE})$ ,  $I_C = 15\text{ mA}$ ,  $f = \text{parameter in GHz}$



**Electrical characteristics**

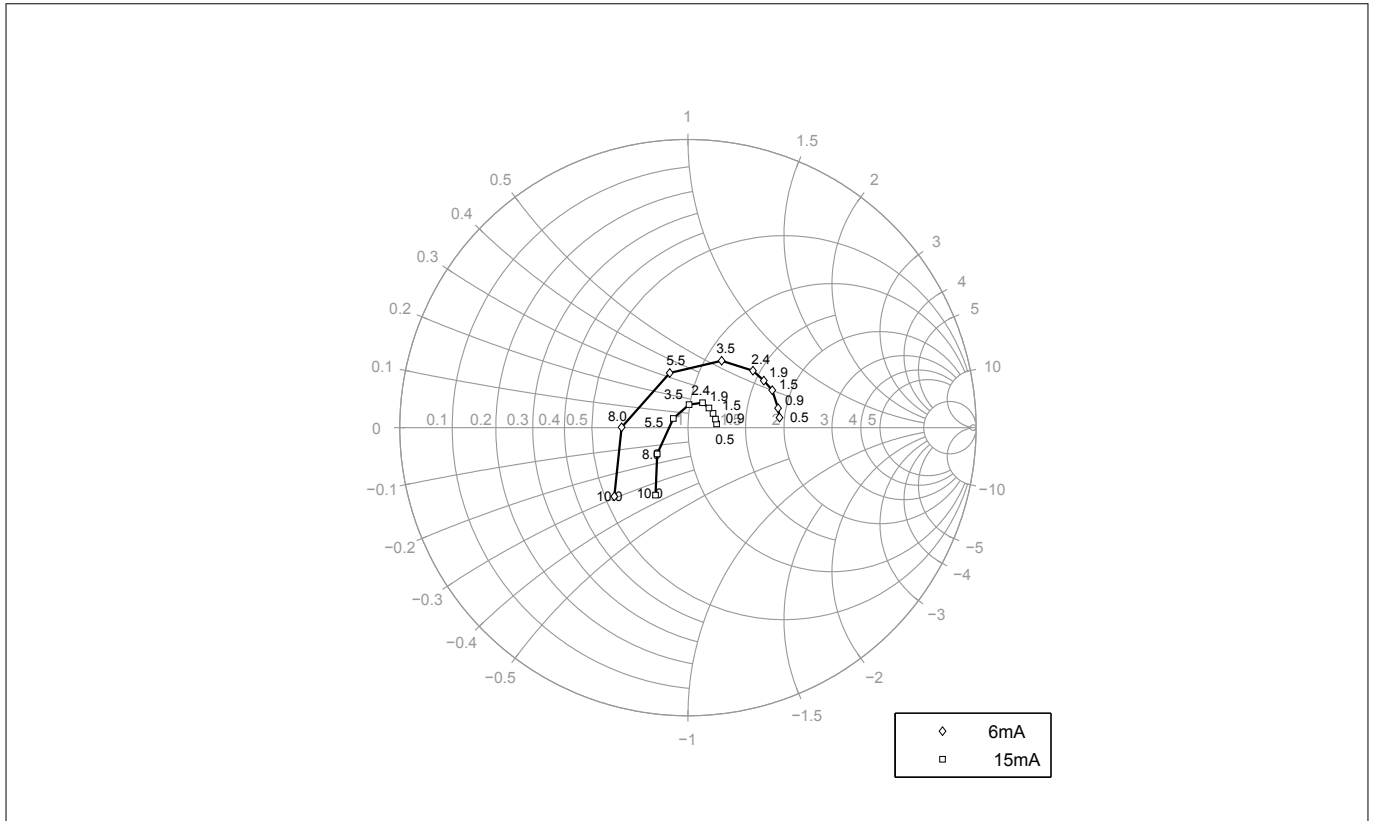


**Figure 16** Input reflection coefficient  $S_{11} = f(f)$ ,  $V_{CE} = 3\text{ V}$ ,  $I_C = 6 / 15\text{ mA}$

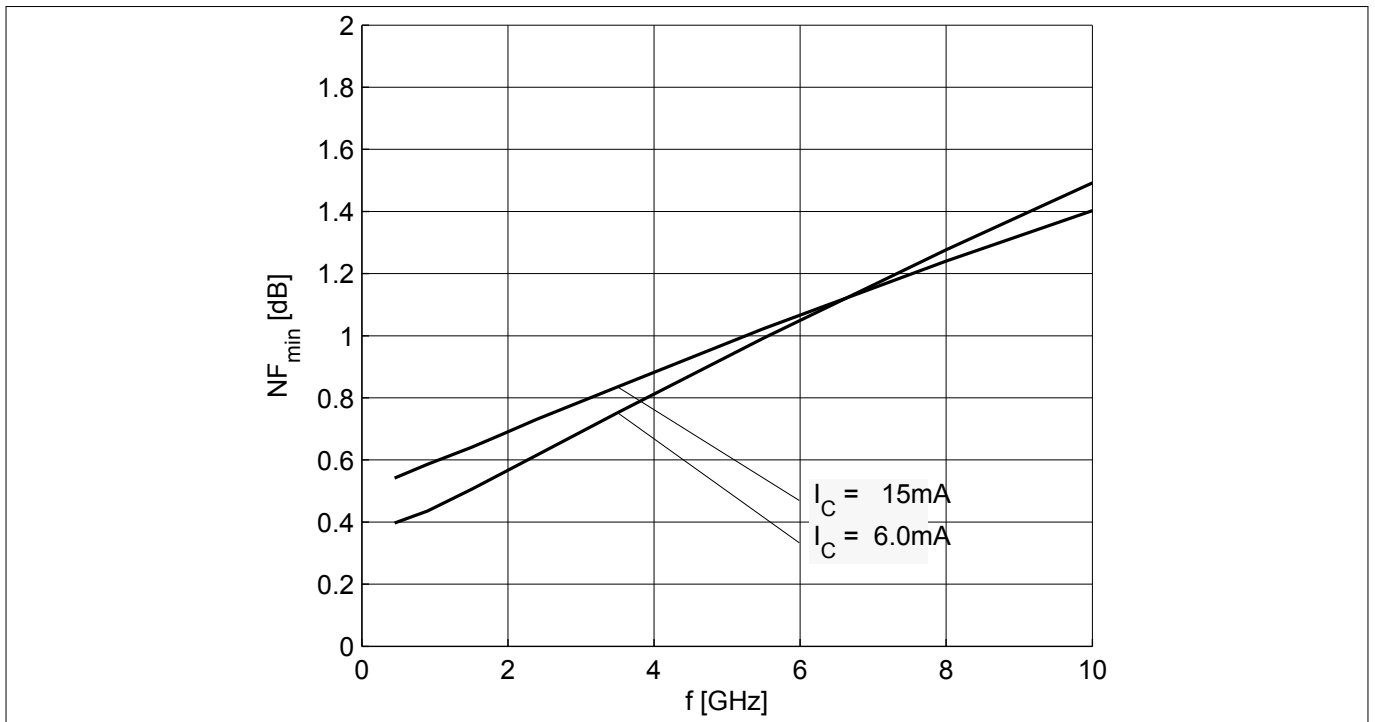


**Figure 17** Output reflection coefficient  $S_{22} = f(f)$ ,  $V_{CE} = 3\text{ V}$ ,  $I_C = 6 / 15\text{ mA}$

**Electrical characteristics**

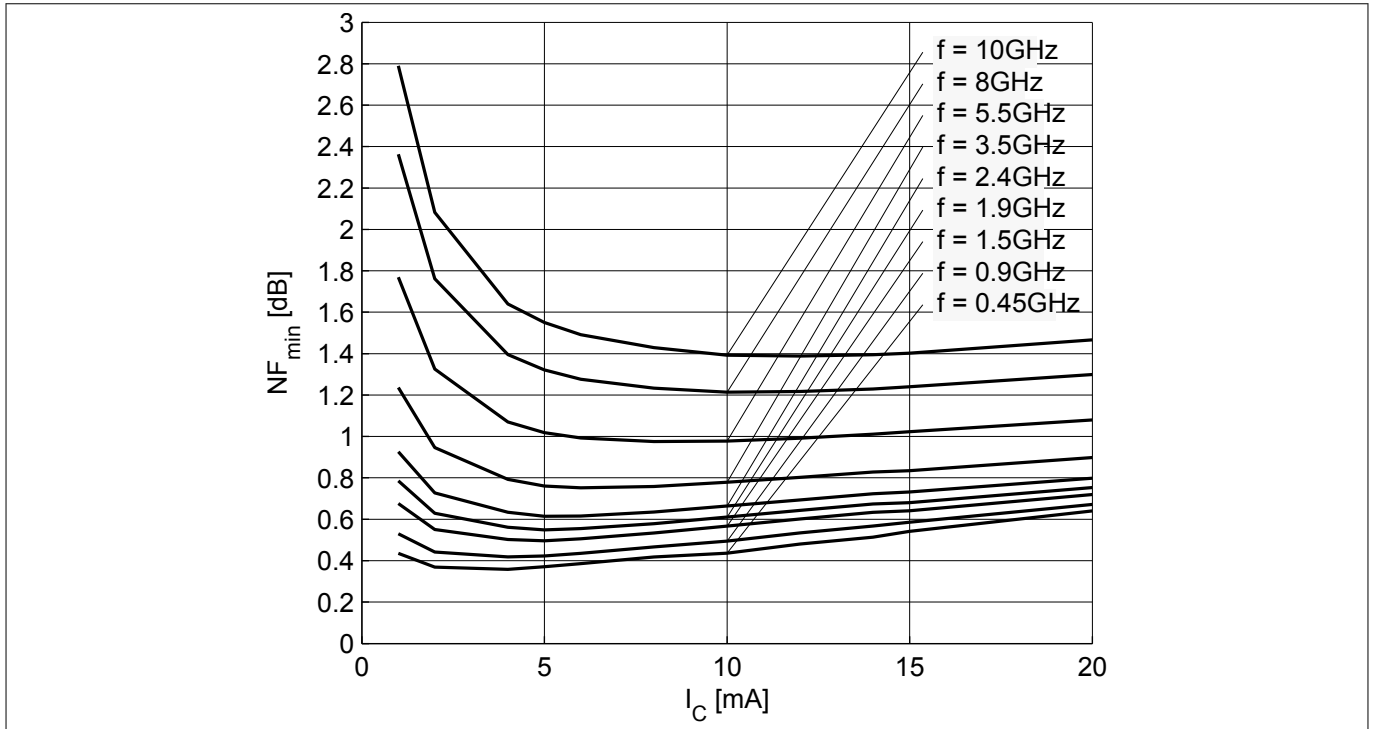


**Figure 18** Source impedance for minimum noise figure  $Z_{S,opt} = f(f)$ ,  $V_{CE} = 3\text{ V}$ ,  $I_C = 6 / 15\text{ mA}$

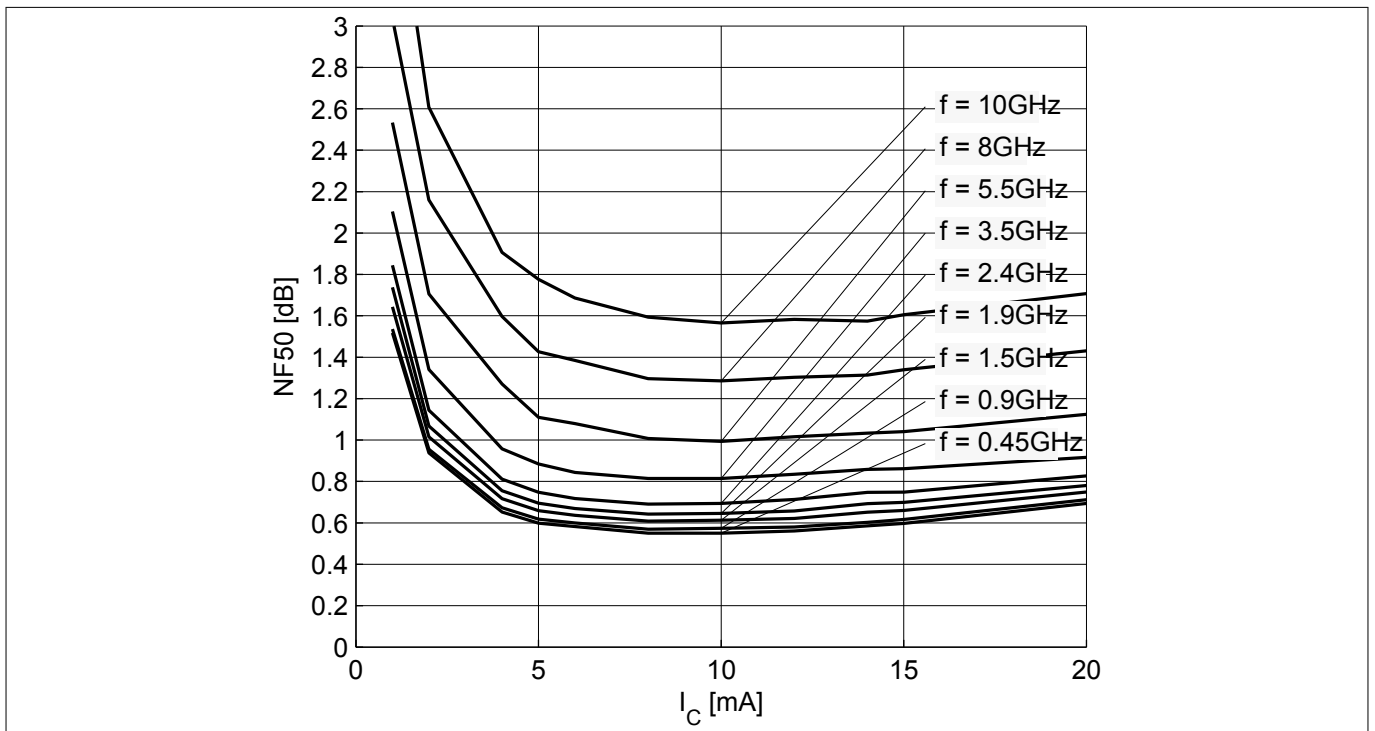


**Figure 19** Noise figure  $NF_{min} = f(f)$ ,  $V_{CE} = 3\text{ V}$ ,  $Z_S = Z_{S,opt}$ ,  $I_C = 6 / 15\text{ mA}$

**Electrical characteristics**



**Figure 20** Noise figure  $NF_{min} = f(I_C)$ ,  $V_{CE} = 3\text{ V}$ ,  $Z_S = Z_{S,opt}$ ,  $f =$  parameter in GHz

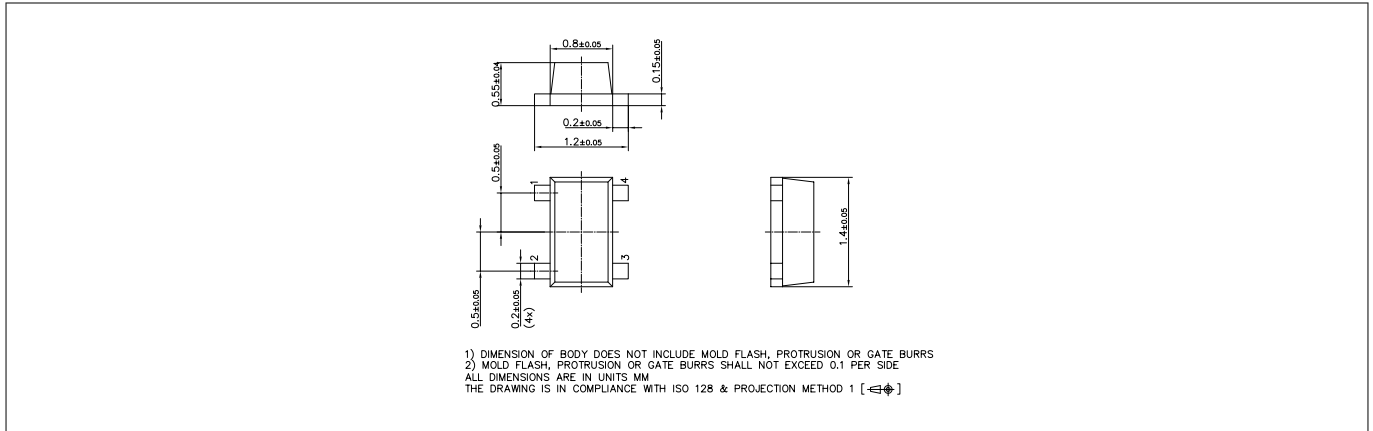


**Figure 21** Noise figure  $NF_{50} = f(I_C)$ ,  $V_{CE} = 3\text{ V}$ ,  $Z_S = 50\ \Omega$ ,  $f =$  parameter in GHz

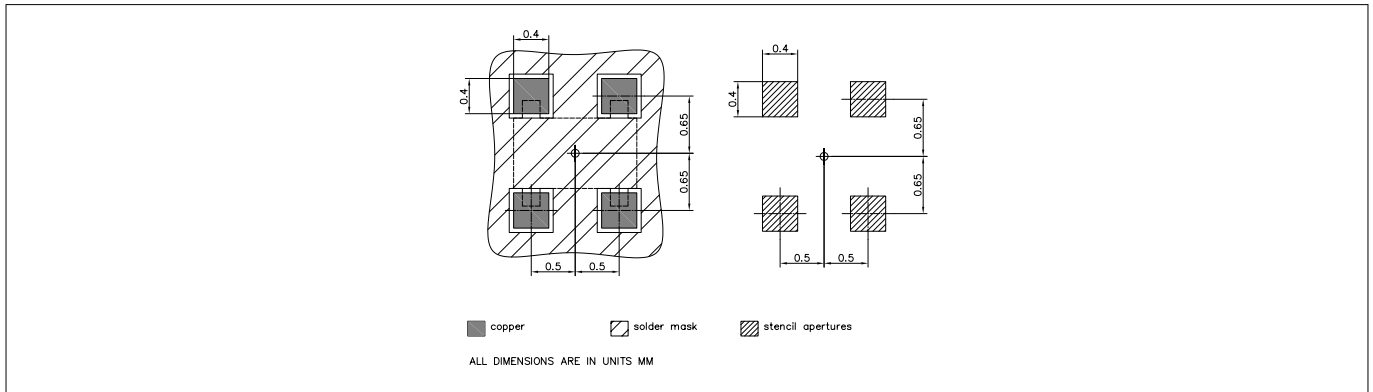
*Note:* The curves shown in this chapter have been generated using typical devices but shall not be considered as a guarantee that all devices have identical characteristic curves.  $T_A = 25\text{ }^\circ\text{C}$ .

**Package information TSFP-4-1**

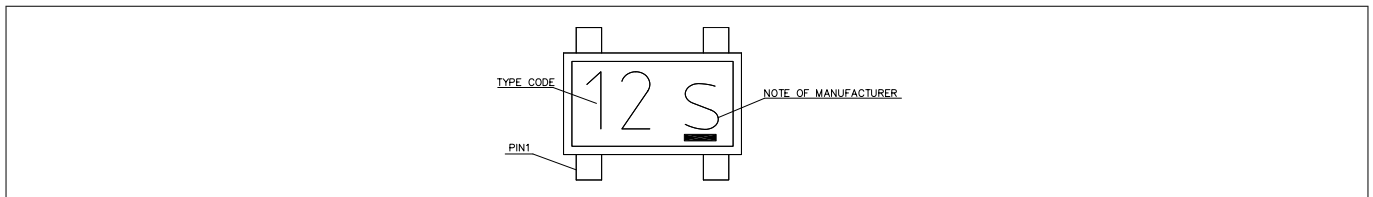
**4 Package information TSFP-4-1**



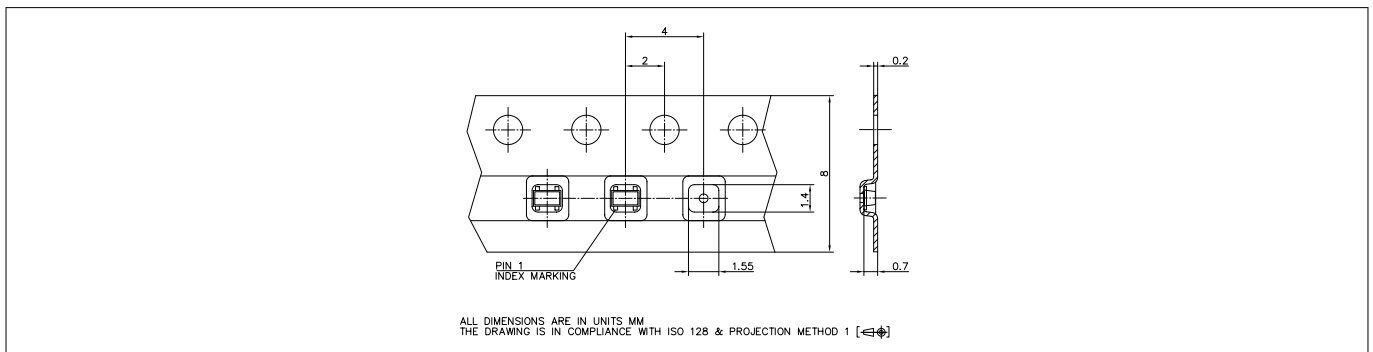
**Figure 22 Package outline**



**Figure 23 Foot print**



**Figure 24 Marking layout example**



**Figure 25 Tape dimensions**

---

Revision history

## Revision history

| Document version | Date of release | Description of changes |
|------------------|-----------------|------------------------|
| 3.0              | 2018-09-26      | New datasheet layout.  |

## Trademarks

All referenced product or service names and trademarks are the property of their respective owners.

**Edition 2018-09-26**

**Published by**  
**Infineon Technologies AG**  
**81726 Munich, Germany**

**© 2018 Infineon Technologies AG**  
**All Rights Reserved.**

**Do you have a question about any**  
**aspect of this document?**  
**Email: [erratum@infineon.com](mailto:erratum@infineon.com)**

**Document reference**  
**IFX-akc1519904148732**

## IMPORTANT NOTICE

The information given in this document shall in no event be regarded as a guarantee of conditions or characteristics ("Beschaffheitsgarantie").

With respect to any examples, hints or any typical values stated herein and/or any information regarding the application of the product, Infineon Technologies hereby disclaims any and all warranties and liabilities of any kind, including without limitation warranties of non-infringement of intellectual property rights of any third party.

In addition, any information given in this document is subject to customer's compliance with its obligations stated in this document and any applicable legal requirements, norms and standards concerning customer's products and any use of the product of Infineon Technologies in customer's applications.

The data contained in this document is exclusively intended for technically trained staff. It is the responsibility of customer's technical departments to evaluate the suitability of the product for the intended application and the completeness of the product information given in this document with respect to such application.

## WARNINGS

Due to technical requirements products may contain dangerous substances. For information on the types in question please contact your nearest Infineon Technologies office.

Except as otherwise explicitly approved by Infineon Technologies in a written document signed by authorized representatives of Infineon Technologies, Infineon Technologies' products may not be used in any applications where a failure of the product or any consequences of the use thereof can reasonably be expected to result in personal injury

# Mouser Electronics

Authorized Distributor

Click to View Pricing, Inventory, Delivery & Lifecycle Information:

[Infineon:](#)

[BFP740FH6327XTSA1](#)