

# SDP8475-201

## Low Light Rejection Phototransistor

### FEATURES

- T-1 plastic package
- Low light level immunity
- 20° (nominal) acceptance angle
- Mechanically and spectrally matched to SEP8505 and SEP8705 infrared emitting diodes

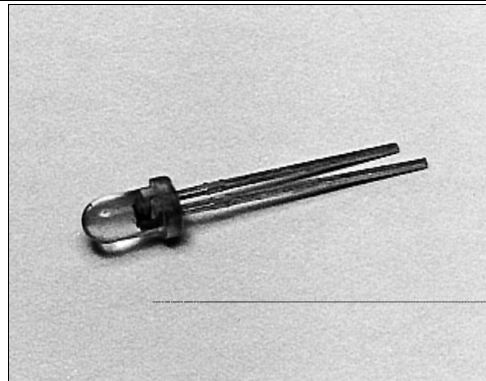

INFRA-22.TIF

### DESCRIPTION

The SDP8475 is an NPN silicon phototransistor which internal base- emitter shunt resistance. Transfer molding of this device in a clear T- 1 plastic package assures superior optical centerline performance compared to other molding processes. Lead lengths are staggered to provide a simple method of polarity identification.

#### Distinguishing Feature:

This device incorporates all of the desired features of a standard phototransistor with the advantage of low light immunity. The phototransistor switching occurs when the incident light increases above the threshold (knee point). When the light level exceeds the knee point of the device, it will function as a standard phototransistor. Chart A illustrates the light current output of the low light rejection phototransistor as compared to a standard phototransistor with similar sensitivity.

#### Typical Application Uses:

Ideally suited for use in applications which require ambient light rejection, or in transmissive applications where the interrupter media is semi-transparent to infrared energy. This device also provides high contrast ratio in reflective applications where unwanted background reflection is a possibility.

### OUTLINE DIMENSIONS in inches (mm)

Tolerance	3 plc decimals	±0.005(0.12)
	2 plc decimals	±0.020(0.51)

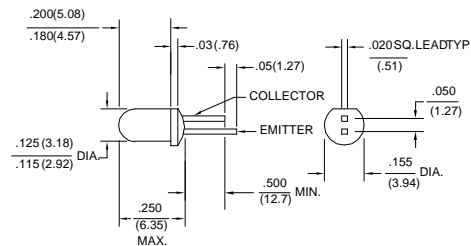

DIM\_100.dwg

# SDP8475-201

## Low Light Rejection Phototransistor

### ELECTRICAL CHARACTERISTICS (25°C unless otherwise noted)

PARAMETER	SYMBOL	MIN	TYP	MAX	UNITS	TEST CONDITIONS
Light Current Slope <sup>(1)</sup> <sup>(2)</sup> SDP8475-201	I <sub>L</sub> Slope	4.0		14.0	mA/mW/cm <sup>2</sup>	V <sub>CE</sub> =5 V H <sub>1</sub> = 0.5 mW/cm <sup>2</sup> H <sub>2</sub> = 0.25 mW/cm <sup>2</sup>
Knee Point <sup>(3)</sup>			0.125		mW/cm <sup>2</sup>	V <sub>CE</sub> =5 V
Collector Dark Current	I <sub>CEO</sub>			100	nA	H=0 mW/cm <sup>2</sup> , V <sub>CE</sub> =15 V
Collector-Emitter Breakdown Voltage	V <sub>(BR)CEO</sub>	30			V	I <sub>C</sub> =100 μA
Collector-Emitter Saturation Voltage	V <sub>CE(SAT)</sub>		0.4		V	I <sub>C</sub> =I <sub>L</sub> /8 H=0.25mW/cm <sup>2</sup>
Reverse Current	I <sub>R</sub>			40	mA	V <sub>CE</sub> =-5.0 V
Angular Response <sup>(4)</sup>	∅		20		degr.	I <sub>F</sub> =Constant
Rise And Fall Time	t <sub>r</sub> , t <sub>f</sub>		15		μs	V <sub>CC</sub> =5 V, I <sub>L</sub> =1 mA R <sub>L</sub> =1000 Ω

#### Notes

- The Slope is calculated with the following equation:  $(I_L @ H_1) - I_L @ H_2) / (H_1 - H_2)$ .
- The radiation source is an IRED with a peak wavelength of 935 nm.
- Knee Point is defined as being the source irradiance required to increase I<sub>L</sub> to 50 μA.
- Angular response is defined as the total included angle between the half sensitivity points.

### ABSOLUTE MAXIMUM RATINGS

(25°C Free-Air Temperature unless otherwise noted)

Collector-Emitter Voltage	30 V
Power Dissipation	70 mW <sup>(1)</sup>
Operating Temperature Range	-40°C to 85°C
Storage Temperature Range	-40°C to 85°C
Soldering Temperature (5 sec)	240°C

#### Notes

- Derate linearly from 25°C free-air temperature at the rate of 0.18 mW/°C.

### SCHEMATIC

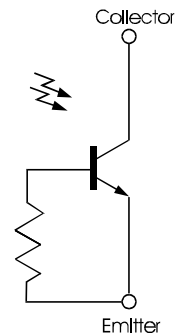

Honeywell reserves the right to make changes in order to improve design and supply the best products possible.

# Honeywell

# SDP8475-201

## Low Light Rejection Phototransistor

SWITCHING TIME TEST CIRCUIT

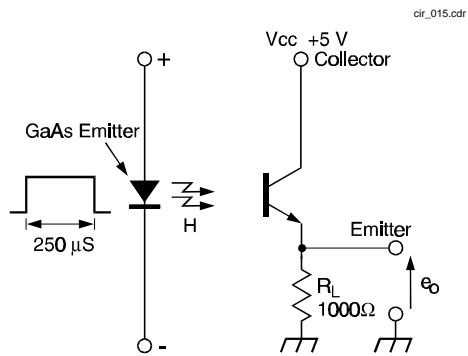

Fig. 1 Responsivity vs Angular Displacement

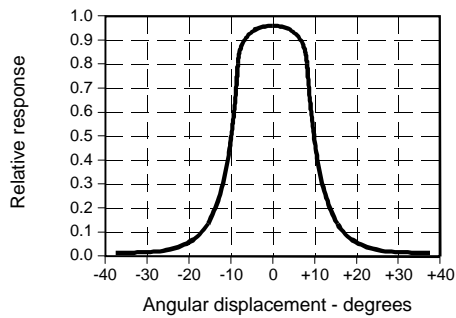
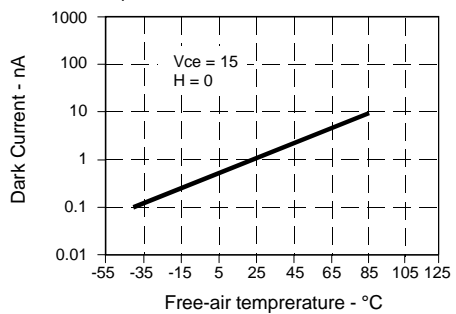

Fig. 3 Dark Current vs Temperature



SWITCHING WAVEFORM

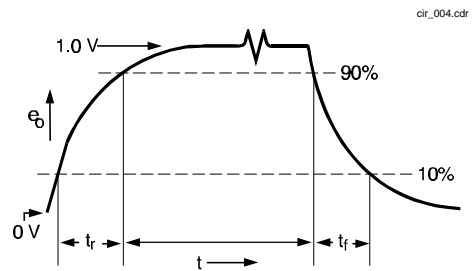

Fig. 2 Spectral Responsivity

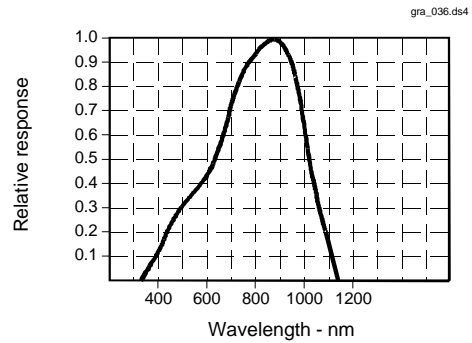
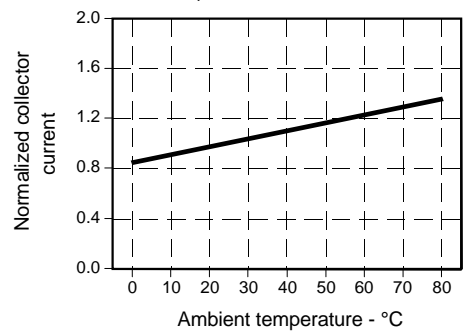

Fig. 4 Collector Current vs Ambient Temperature



All Performance Curves Show Typical Values

# SDP8475-201

## Low Light Rejection Phototransistor

Chart A. Low Light Rejection Phototransistor vs. Standard Phototransistor

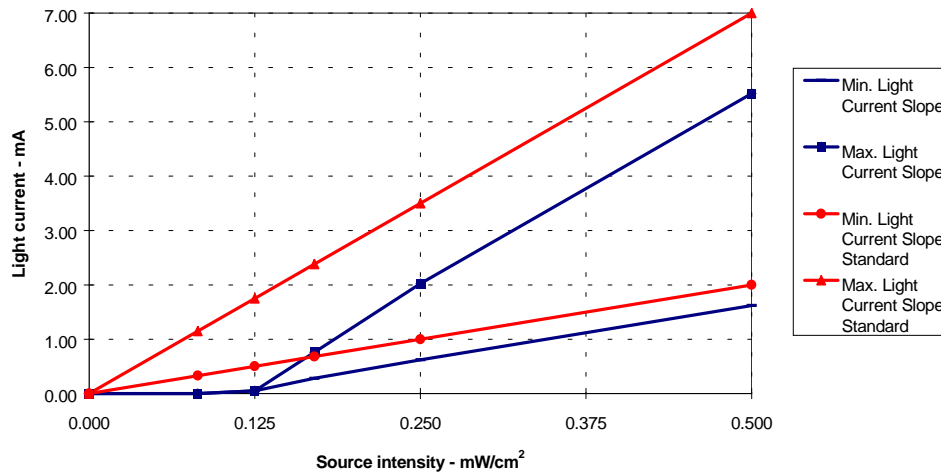

### Designing with the Low Light Rejection Phototransistor:

The Low Light Rejection detector is tested at different incident light levels to determine adherence to the specified knee point and light current slope. This method assures proper functionality vs. standard phototransistors, and guarantees required light current output.

The light current slope is the change in light current output at two given source irradiances divided by the change in the two source irradiances.

#### (Formula # 1)

$$I_L \text{ Slope} = [I_{L1} (@ H_1) - I_{L2} (@ H_2)] / [H_1 - H_2]$$

Where:

- $I_L$  slope is the light current slope in mA/mW/cm<sup>2</sup>
- $I_L$  is the light current output in mA
- $H$  is the source intensity in mW/cm<sup>2</sup>

Chart A shows the specified limits of light current slope for the low light rejection phototransistor which begins its slope at the typical knee point, 0.125mW/cm<sup>2</sup>. To make a clear distinction between this device and a standard phototransistor, light current slopes for high and low sensitivity standard phototransistors are also shown. Note that for phototransistors of the same gain, the slopes of the two products are parallel.

The knee point, the source irradiance needed to increase  $I_L$  to 50uA, is a necessary parameter for circuit design. All variation in the knee point will be offset by the internally guardbanded light current slope limits. The appropriate formula for circuit design is the following:

#### (Formula # 2)

$$I_L = I_L \text{ slope}_{\text{MIN.}} * (H_A - H_{\text{KP}})$$

Where:

- $I_L$  is the light current output in mA
- $I_L \text{ slope}_{\text{MIN.}}$  is the minimum limit on the light current slope (i.e. 4.0mA/mW/cm<sup>2</sup>)
- $H_A$  is the source light incident on the detector for the application
- $H_{\text{KP}}$  is the specified level of source light incident on the detector at the typical knee point (i.e. 0.125 mW/cm<sup>2</sup>)

#### Example :

To design a transmissive sensor with two of Honeywell's standard components, the SEP8505-002 and the SDP8475-201, it is first necessary to determine the irradiance level in mW/cm<sup>2</sup> that will be incident on the detector. The application conditions are the following:

# SDP8475-201

## Low Light Rejection Phototransistor

---

Supply voltage = 5V

Distance between emitter and detector = 0.4 in.  
(10.16mm)

IRED drive current = 20mA

The SEP8505-002 gives 1.0mW/cm<sup>2</sup> min. to 4.0mW/cm<sup>2</sup> max. under the above conditions. To obtain minimum light current output, use the minimum irradiance limit.

Light current output =  $I_L \text{ slope}_{\text{min}} * (H_{\lambda} - H_{\lambda p})$

Light current output = 4.0 mA/mW/cm<sup>2</sup> min. \* (1.0 mW/cm<sup>2</sup> min. - 0.125 mW/cm<sup>2</sup>) = 3.5mA min.

# Mouser Electronics

Authorized Distributor

Click to View Pricing, Inventory, Delivery & Lifecycle Information:

[Honeywell:](#)

[SDP8475-201](#)