

ELV. RoHS COMPLIANT

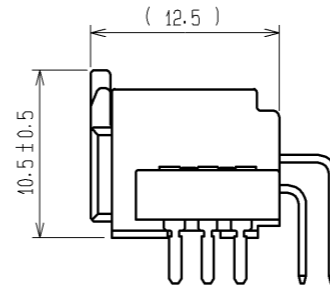

MATED CONNECTORS

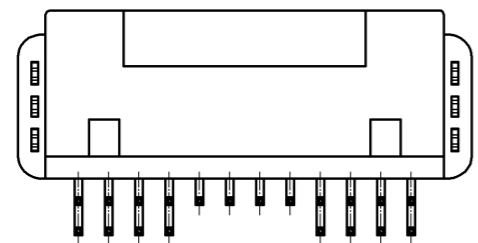
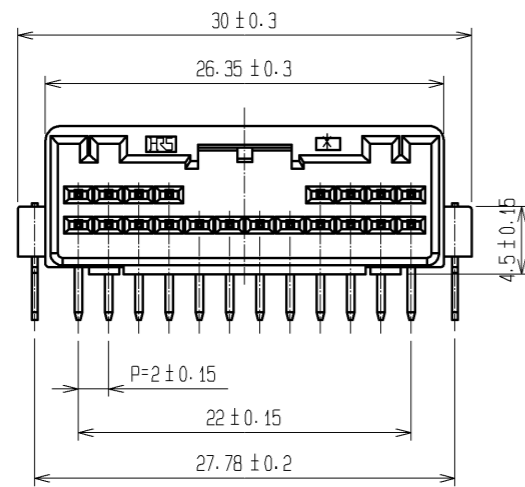
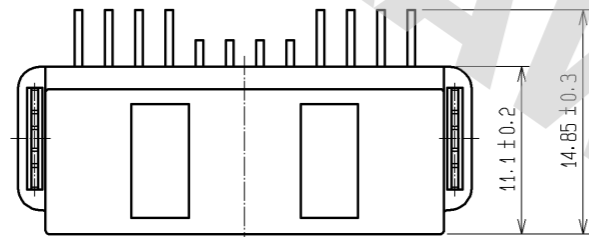
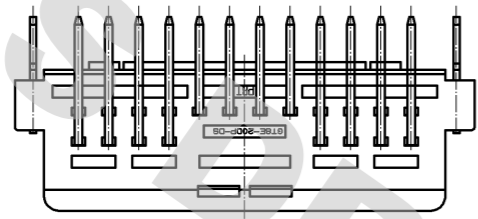
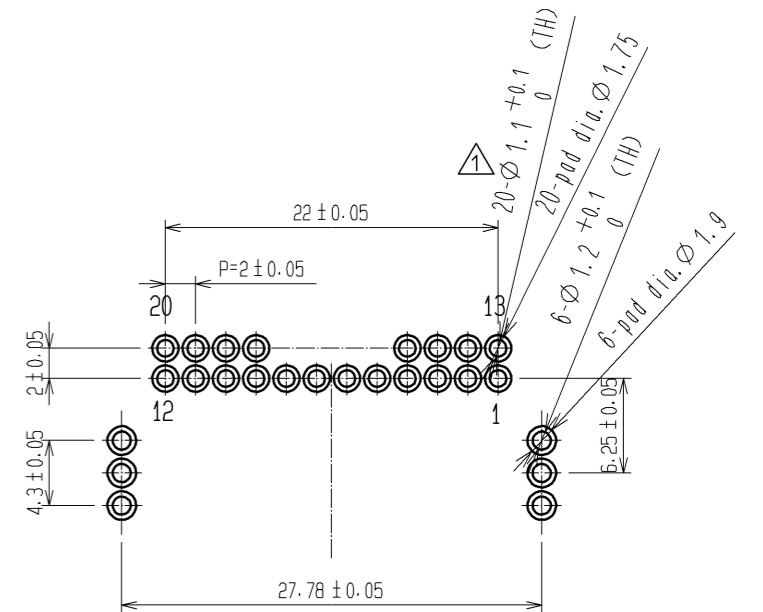

RECOMMENDED PC BOARD PATTERN (CONNECTOR SIDE) AND PIN No.

Drawing for packing.

Note1. Six trays(A,B) to be piled in turn. Top(the seventh step) is an empty tray. (One tray includes 80 pcs of products. One bundle: 80×6=480 pcs.)

Note2. One K-1 box includes 960 pcs. (480×2=960)

Note3. The size of the tray see below.

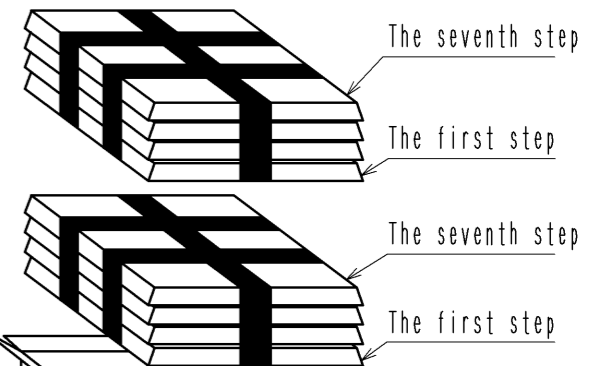

| | | | | | |
|--------------------------------------|-------|----------------|----------|----------------------|------------------|
| 2 | BRASS | TIN PLATING | 4 | BRASS | TIN PLATING |
| 1 | PBT | BLACK | 3 | BRASS | TIN PLATING |
| 部番 | 材質 | 処理, 備考 | 部番 | 材質 | 処理, 備考 |
| UNITS mm | | SCALE 2 : 1 | | 訂正記事 DIS-T-002171 | 設計 Chinaik.Ng |
| HRS HIROSE ELECTRIC CO., LTD. | 承認 | AR. SHIRAI | 09.06.15 | 図番 | EDC3-166701-00 |
| | 検 | AR. SHIRAI | 09.06.15 | 製品名 | GT8E-20DP-DS |
| | 設 | YN. KADOTA | 09.06.15 | 製品 | CL758-0046-6-00 |
| | 製 | YN. KADOTA | 09.06.15 | コード | |
| | | | | | 年月日 11.03.25 |
| | | | | | 検 AR. SHIRAI |

DRAWING FOR REFERENCE: This is subject to change without notice 08/11/2012

Mouser Electronics

Authorized Distributor

Click to View Pricing, Inventory, Delivery & Lifecycle Information:

[Hirose Electric:](#)

[GT8E-20DP-DS](#)