

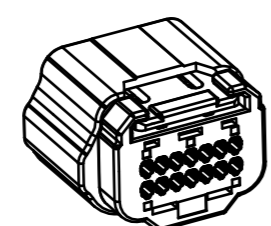

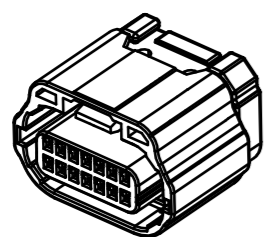
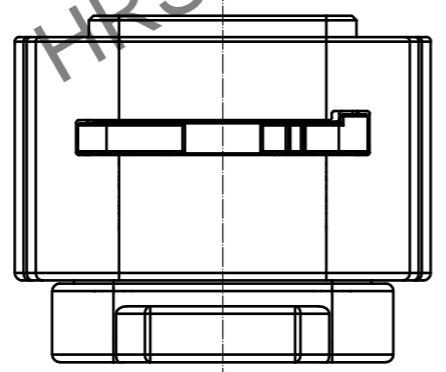
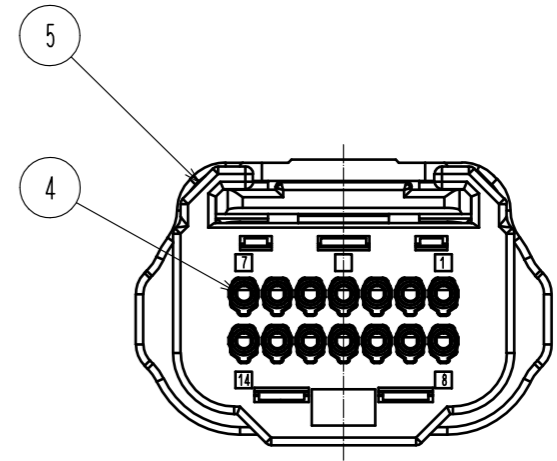
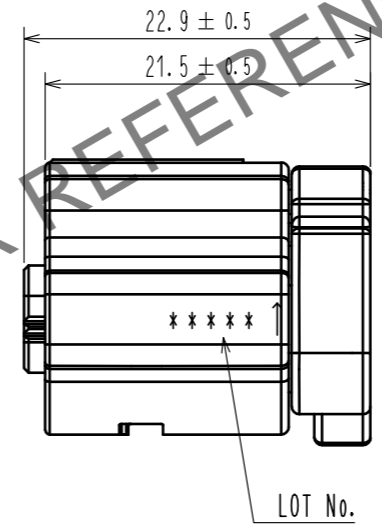
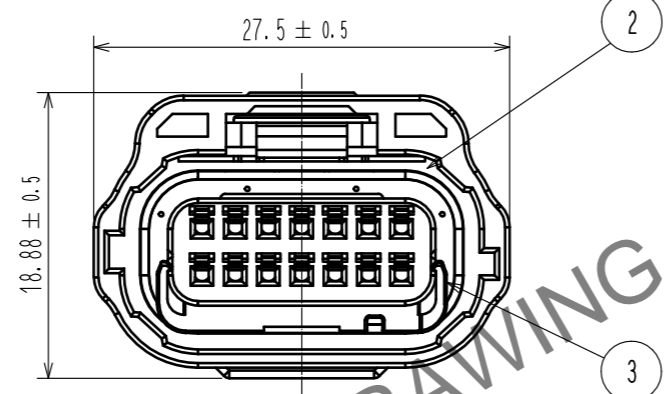
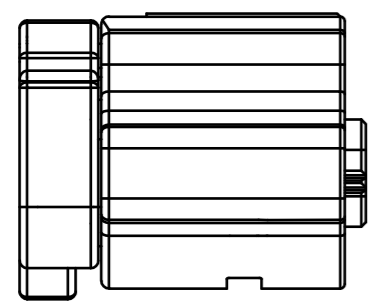
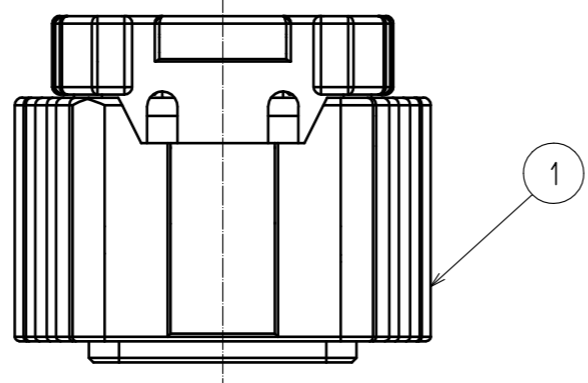
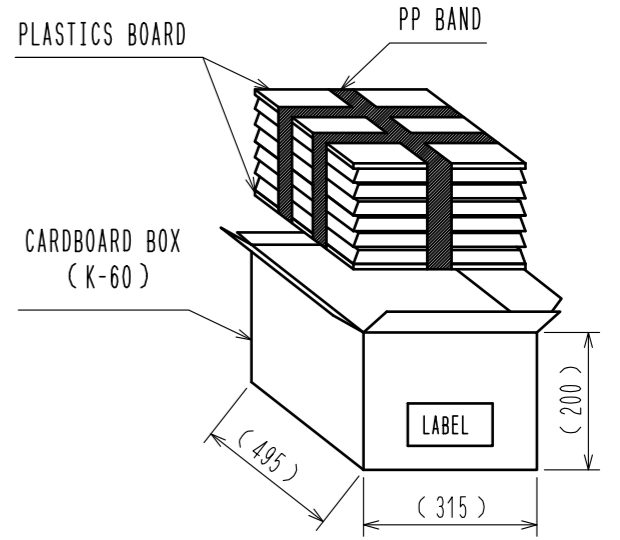

Dec.1.2024 Copyright 2024 HIROSE ELECTRIC CO., LTD. All Rights Reserved.
In case of consideration for using Automotive equipment / device which demand high reliability, kindly contact our sales window correspondents.

ELV, RoHS COMPLIANT  DELETE PAGES 2-5

 PACKING STYLE



- NOTE1. APPLICABLE MATING CONNECTOR : ZE064W-14DP-HU/R(B)
 2. THE APPLICABLE PARTS ARE AS FOLLOWS.
 CRIMP CONTACT : ZE064-2022SCF
 WATERPROOF CAP : ZE064W-WCP(2022)
 MAXIMUM NUMBER OF PRODUCT PER BOX: 96 PCS PER TRAY × 5 LAYERS = 480 PCS.
 PUT AN EMPTY TRAY ON THE TOP ROW.
 4. BEFORE USE, BE SURE TO REFER TO THE INSTRUCTION MANUAL ETAD-T0644-00.

NO.	MATERIAL	FINISH . REMARKS	NO.	MATERIAL	FINISH . REMARKS
3	PA	BEIGE, UL94 V-0			
2	SILICONE	RED, OIL BLEEDING 	5	PBT	GRAY, UL94 V-0
1	PA	GRAY, UL94 V-0	4	SILICONE	RED, OIL BLEEDING 

UNITS	SCALE	COUNT	DESCRIPTION OF REVISIONS	DESIGNED	CHECKED	DATE
mm	2 : 1	 4	DIS-T-00016744	TY. MOGI	AH. EDASHIGE	20230124

APPROVED : HK. UMEHARA	20190108	DRAWING NO.	EDC-378451-00-00
CHECKED : HK. UMEHARA	20190108	PART NO.	ZE064W-14DS-HU/R(B)
DESIGNED : HH. TSUKUMO	20190108	CODE NO.	CL0753-2011-0-00
DRAWN : GYEONGMIN LEE	20190108		

Mouser Electronics

Authorized Distributor

Click to View Pricing, Inventory, Delivery & Lifecycle Information:

[Hirose Electric:](#)

[ZE064W-14DS-HU/R\(B\)](#)