

Sep.1.2021 Copyright 2021 HIROSE ELECTRIC CO., LTD. All Rights Reserved.
 In case of consideration for using Automotive equipment / device which demand high reliability, kindly contact our sales window correspondents.

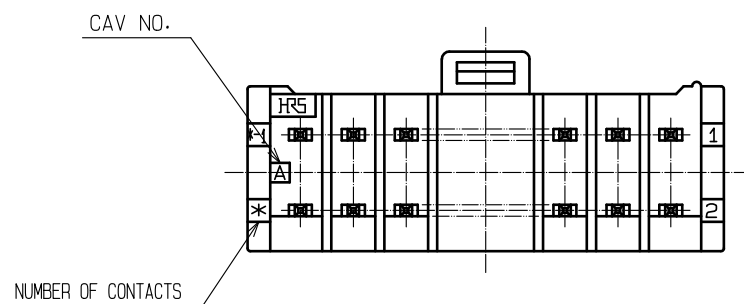

CODE NO.	PART NO.	NUMBER OF CONTACTS	A	B
CL547-0083-2-23	MDF6- 4DP-3.5DSA(23)	4	10.5	3.5
CL547-0084-5-23	MDF6- 6DP-3.5DSA(23)	6	14.0	7.0
CL547-0085-8-23	MDF6- 8DP-3.5DSA(23)	8	17.5	10.5
CL547-0086-0-23	MDF6-10DP-3.5DSA(23)	10	21.0	14.0
CL547-0087-3-23	MDF6-12DP-3.5DSA(23)	12	24.5	17.5
CL547-0088-6-23	MDF6-14DP-3.5DSA(23)	14	28.0	21.0
CL547-0089-9-23	MDF6-16DP-3.5DSA(23)	16	31.5	24.5
CL547-0090-8-23	MDF6-18DP-3.5DSA(23)	18	35.0	28.0
CL547-0091-0-23	MDF6-20DP-3.5DSA(23)	20	38.5	31.5

NOTE 1 : RECOMMENDED PC BOARD HOLE DIAMETER $\phi 1.3 \begin{smallmatrix} +0.1 \\ 0 \end{smallmatrix}$
 2 : UL (FILE No. E52653)
 CSA (FILE No. LR95109) AUTHORIZATION ARTICLE.

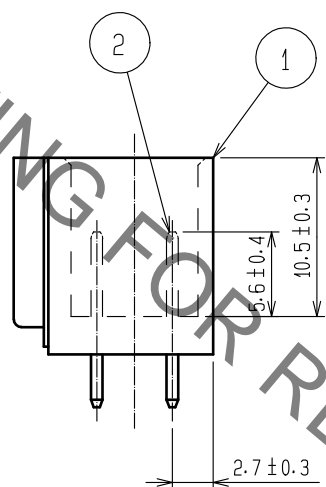
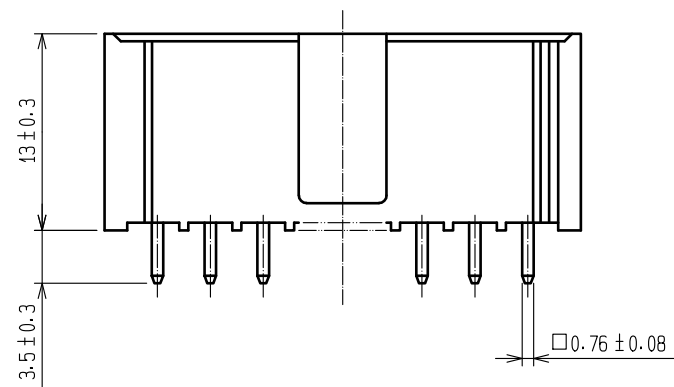
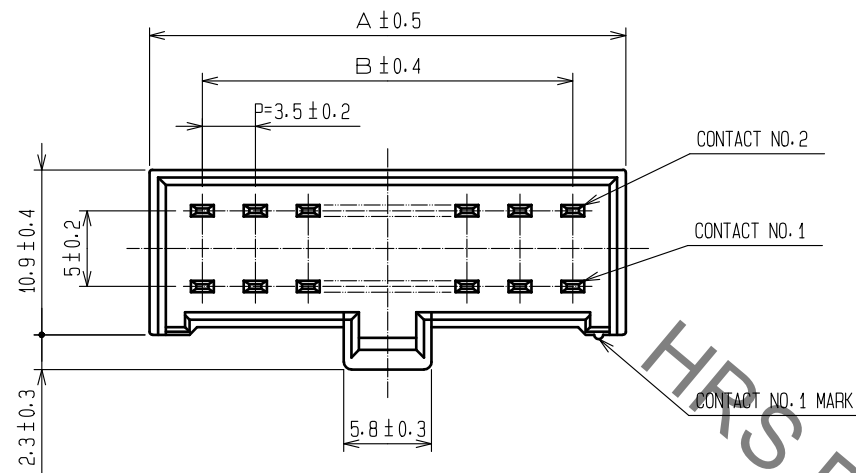

1	POLYAMIDE	NATURAL (WHITE), UL94V-0	2	BRASS	SURFACE:TIN PLATED 1μm min UNDER PLATING:NICKEL 1μm min		
NO.	MATERIAL	FINISH, REMARKS	NO.	MATERIAL	FINISH, REMARKS		
UNITS mm		SCALE 10:1	COUNT	DESCRIPTION OF REVISIONS	DESIGNED	CHECKED	DATE
HRS HIROSE ELECTRIC CO., LTD.		APPROVED : HS. OKAWA	20200313	DRAWING NO.	EDC-160046-23-00		
		CHECKED : TS. KUMAZAWA	20200313	PART NO.	MDF6- * DP-3.5DSA(23)		
		DESIGNED : HK. HAYASHI	20200313	CODE NO.	CL547-		
		DRAWN : DS. HIROWATARI	20200306		1/1		

Mouser Electronics

Authorized Distributor

Click to View Pricing, Inventory, Delivery & Lifecycle Information:

[Hirose Electric:](#)

[MDF6-20DP-3.5DSA\(23\)](#)