

Sep.1.2021 Copyright 2021 HIROSE ELECTRIC CO., LTD. All Rights Reserved.
In case of consideration for using Automotive equipment / device which demand high reliability, kindly contact our sales window correspondents.

ELV, RoHS COMPLIANT

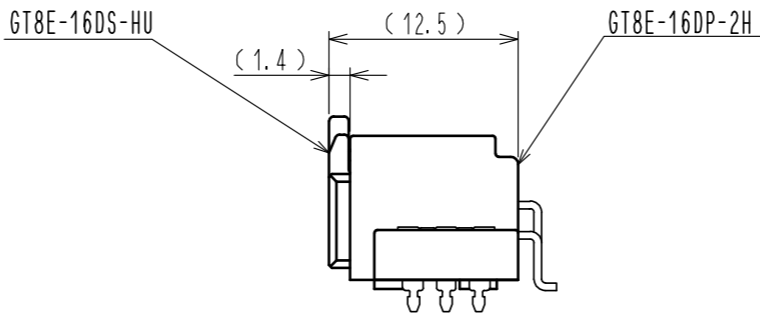
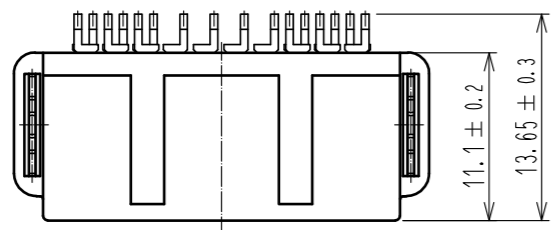

MATED CONNECOTORS

PIN-NO. 16 10 15 9 14 8 7 6 5 4 13 3 12 2 11 1

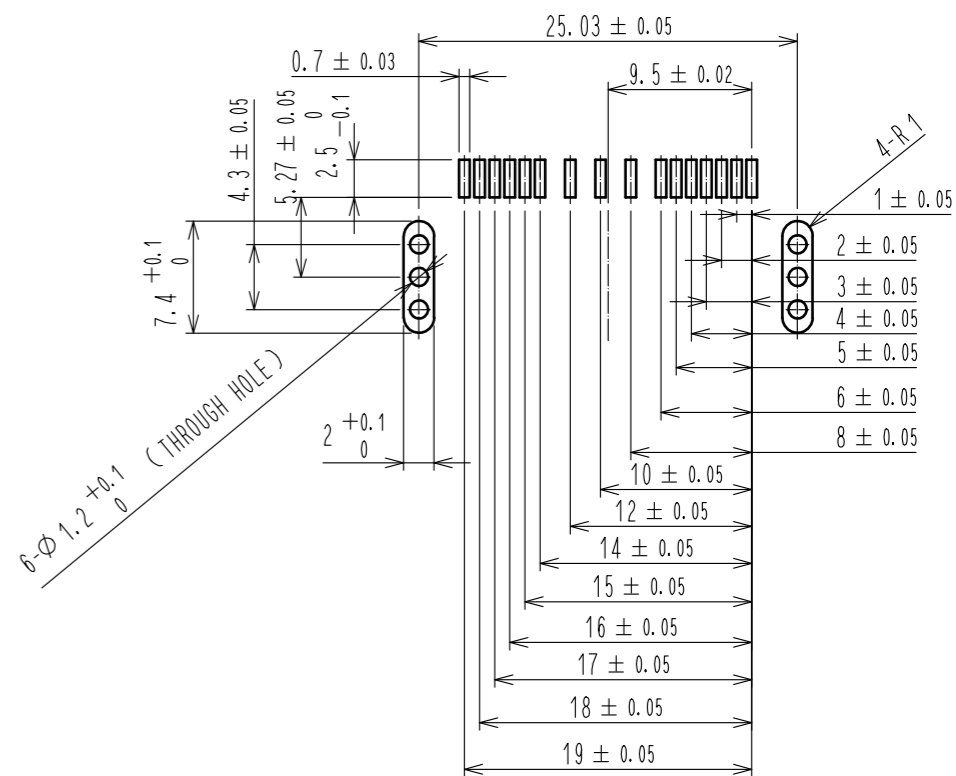

RECOMMENDED PC BOARD PATTERN (CONNECTOR SIDE)

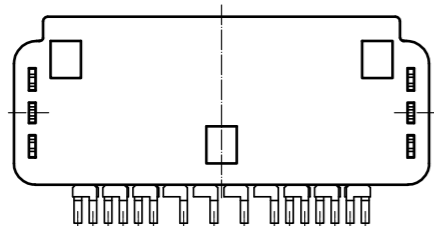
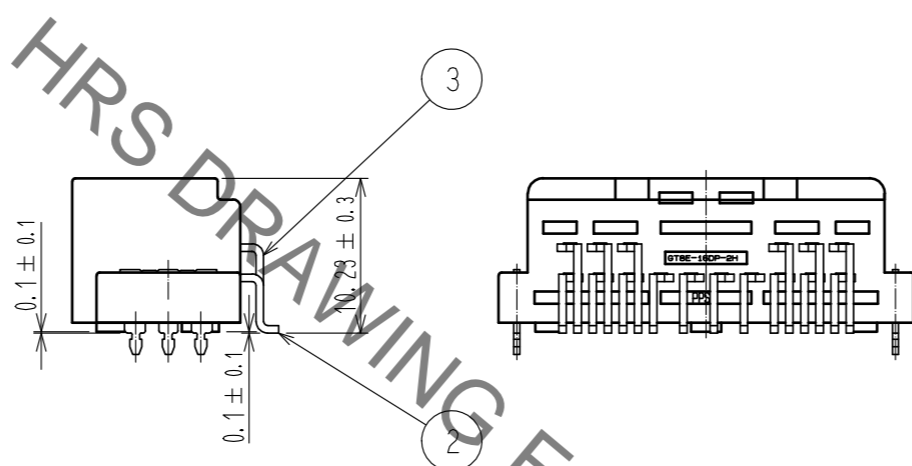
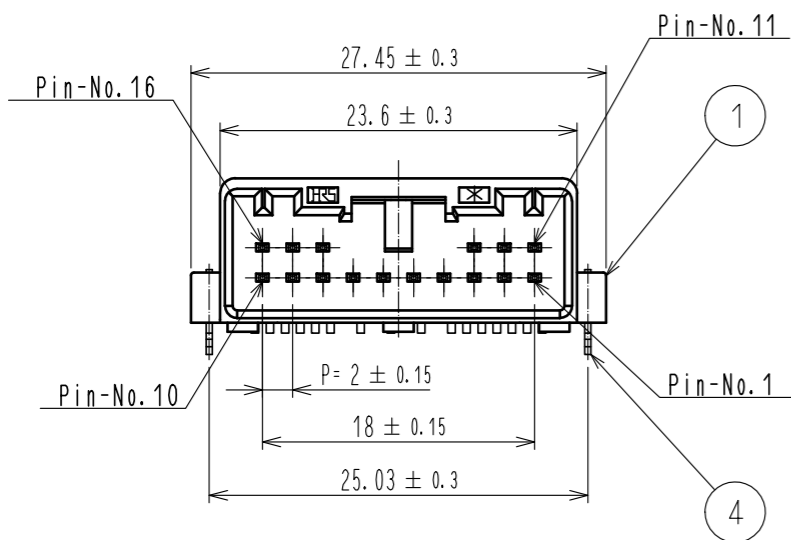

- NOTE 1. RECOMMENDED REFLOW TEMPERATURE PROFILE (REFER RIGHT FIG.)
 REFLOW HEATING: FAR-INFLARED, IN THE AIR OR NITROGEN
 NUMBER OF REFLOW CYCLES: 2 CYCLES MAX
 PEAK TEMPERATURE: 250°C
 ABOVE 230°C: 20~40s
 PREHEAT: 150~180°C (60~120s)
 2. SOLDERING TEMPERATURE: 280~300°C (MAX 2s)
 3. COPLANARITY OF LEADS SHALL BE 0.1mm MAX.
 4. RECOMMENDED THICKNESS FOR PC BOARD IS 1.6mm.
 5. RECOMMENDED THICKNESS FOR SOLDER PASTE IS 0.15mm.

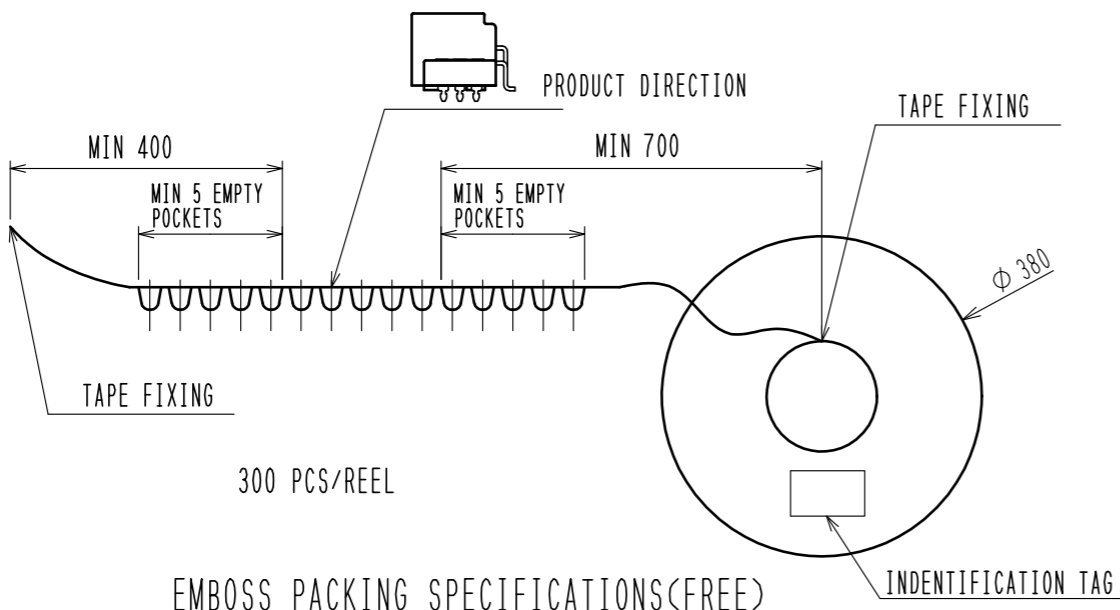
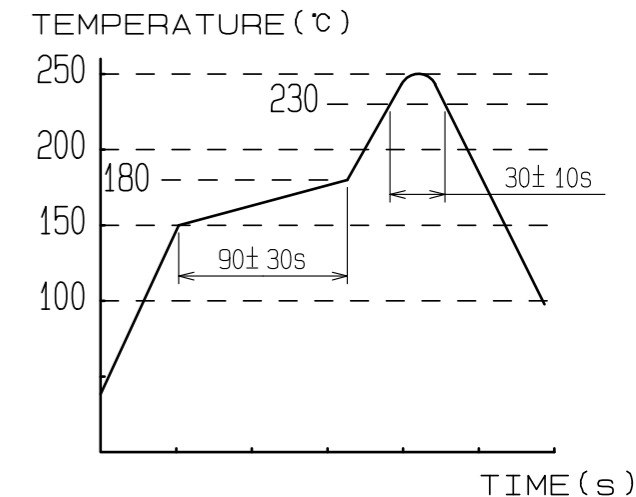

2	BRASS	TIN PLATING	4	BRASS	TIN PLATING
1	PPS	BLACK	3	BRASS	TIN PLATING
NO.	MATERIAL	FINISH . REMARKS	NO.	MATERIAL	FINISH . REMARKS
UNITS mm		SCALE 2 : 1	COUNT 	DESCRIPTION OF REVISIONS	DESIGNED
HRS HIROSE ELECTRIC CO., LTD.		APPROVED : HH. TSUKUMO	20200321	DRAWING NO.	EDC-167885-55-00
		CHECKED : HH. TSUKUMO	20200321	PART NO.	GT8E-16DP-2H(55)
		DESIGNED : DONGCHAN KIM	20200221	CODE NO.	CL758-1009-5-55
		DRAWN : YK. MITSUISHI	20200220		1/1

Mouser Electronics

Authorized Distributor

Click to View Pricing, Inventory, Delivery & Lifecycle Information:

[Hirose Electric:](#)

[GT8E-16DP-2H\(55\)](#)