

COUNT	DESCRIPTION OF REVISIONS	BY	CHKD	DATE	COUNT	DESCRIPTION OF REVISIONS	BY	CHKD	DATE
△					△				
△					△				
△					△				

NOTE1. THIS CONNECTOR SHALL BE USED WITH A RETAINER
 (CL755-0006-2).

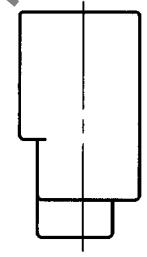
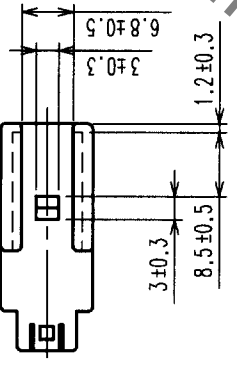
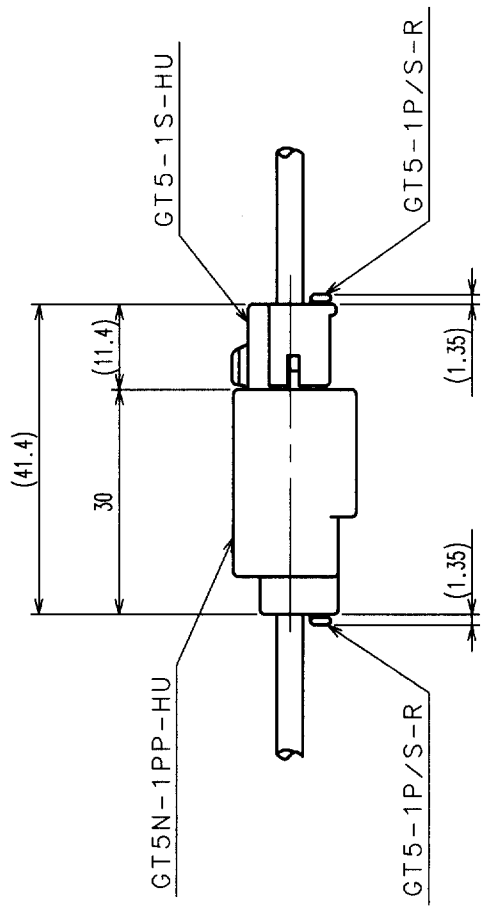
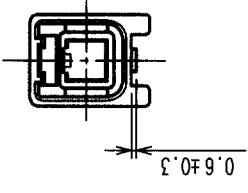
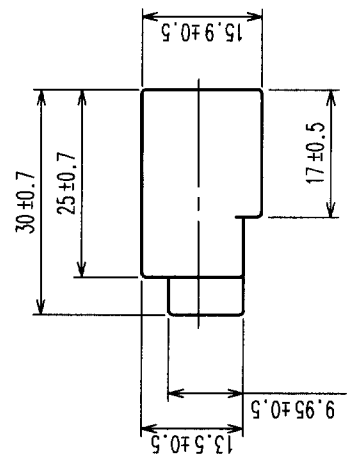
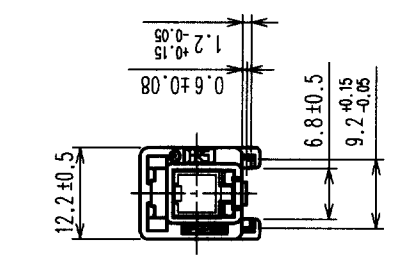
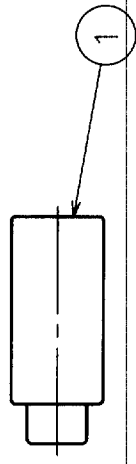

MATED CONNECTORS

HRS DRAWING FOR REFERENCE

1		UL94HB, LIGHT GRAY		FINISH, REMARKS		MATERIAL		FINISH, REMARKS	
NO.	CODE NO. (OLD)	MATERIAL	FINISH, REMARKS	NO.	DESIGNED	CHECKED	APPROVED	RELEASED	
					T. IKEDA	<i>M. Shoda</i>	<i>K. Aoto</i>		
					'01 12 03	'01 12 11	'02 12 25		
DRAWING NO.		EDC3-165658		PART NO.		GT5N-1PP-HU			
SCALE		1 : 1		CODE NO.		CL755-0090-9			
UNITS		mm		DRAWING NO.		HIROSE ELECTRIC CO., LTD			

TO			
----	--	--	--

Mouser Electronics

Authorized Distributor

Click to View Pricing, Inventory, Delivery & Lifecycle Information:

[Hirose Electric:](#)

[GT5N-1PP-HU](#)