

1:0.2±0.05×w:0.35±0.05

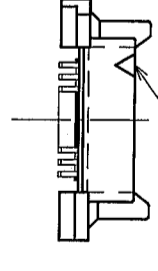

POLARIZATION MARK

P.C.B.MOUNTING LAYOUT(TOP VIEW)

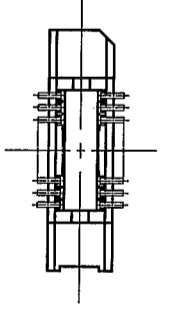
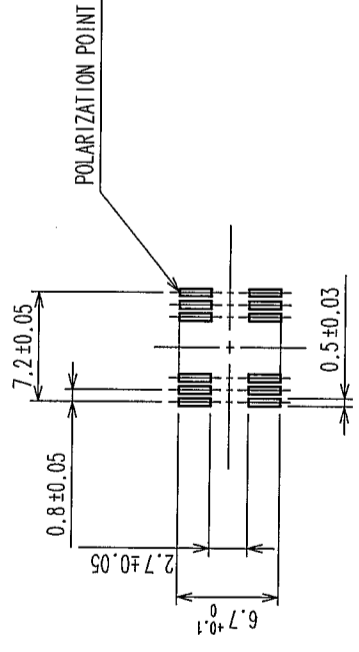

A-A(10:1)

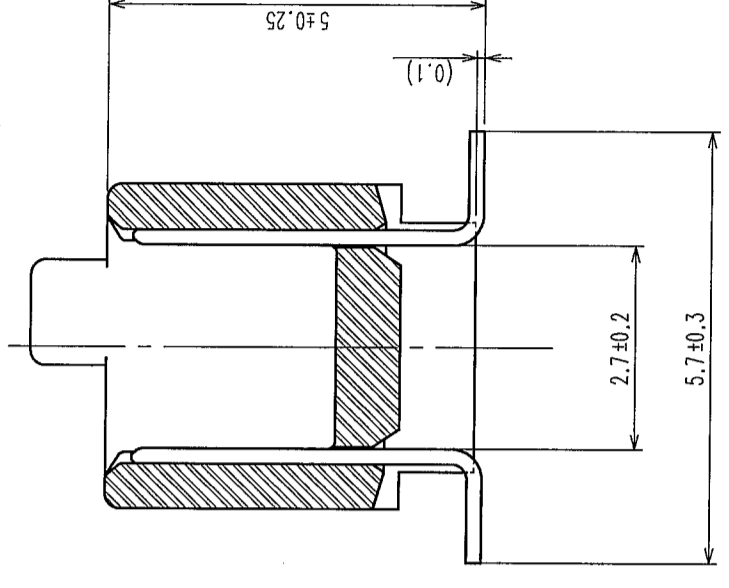

- NOTE 1 HRS MARK SHALL BE OPTIONAL.  
 2 LEAD CO-PLANARITY SHALL BE 0.1mm MAX.  
 3 THE DIMENSIONS IN PARENTHESES ARE FOR REFERENCE.  
 4 EMBOSSED CARRIER TAPE PACKAGING SHALL BE APPLIED FOR THIS PRODUCT.  
 5 FOR MODIFICATION, ETC., PREVENTIVE HOLE FOR SINK MARK MAY BE ADDED ACCORDING TO CIRCUMSTANCES.

COUNT	DESCRIPTION OF REVISIONS	BY	CHKD	DATE	COUNT	DESCRIPTION OF REVISIONS	BY	CHKD	DATE
△					△				
△					△				
△					△				

1	POLYPHENYLENE SULFIDE	LIGHT BROWN	UL-94V-0	2	PHOSPHOR BRONZE	CONTACT AREA : GOLD 0.1μm min. LEAD AREA : TIN-PLATING 1μm min. UNDER PLATING : NICKEL 1μm min.			
NO.	MATERIAL	FINISH, REMARKS		NO.	MATERIAL	FINISH, REMARKS			
CODE NO. (OLD)	CL	DRAWN		DESIGNED	CHECKED	APPROVED	RELEASED		
		Y. AOYAGI		J. Mada	K. Ogawa	H. Okawa			
		'05.09.15		'05.09.26	'05.09.26	'05.09.26			
DRAWING NO.	EDC3-071315-22		PART NO.		FX6A-20P-0.8SV1(92)				
SCALE	2 : 1		CODE NO.		CL576-0221-0-92				
UNITS	mm		HIROSE ELECTRIC CO., LTD						

HRS DRAWING FOR REFERENCE

2 In case of consideration for using Automotive equipment / device which demand high reliability, kindly contact our sales window correspondents.

3 Sep.1.2021 Copyright 2021 HIROSE ELECTRIC CO., LTD. All Rights Reserved.

DESCRIPTION OF REVISIONS	BY	CHKD	DATE	COUNT	DESCRIPTION OF REVISIONS	BY	CHKD	DATE

DIRECTION OF UNREELING

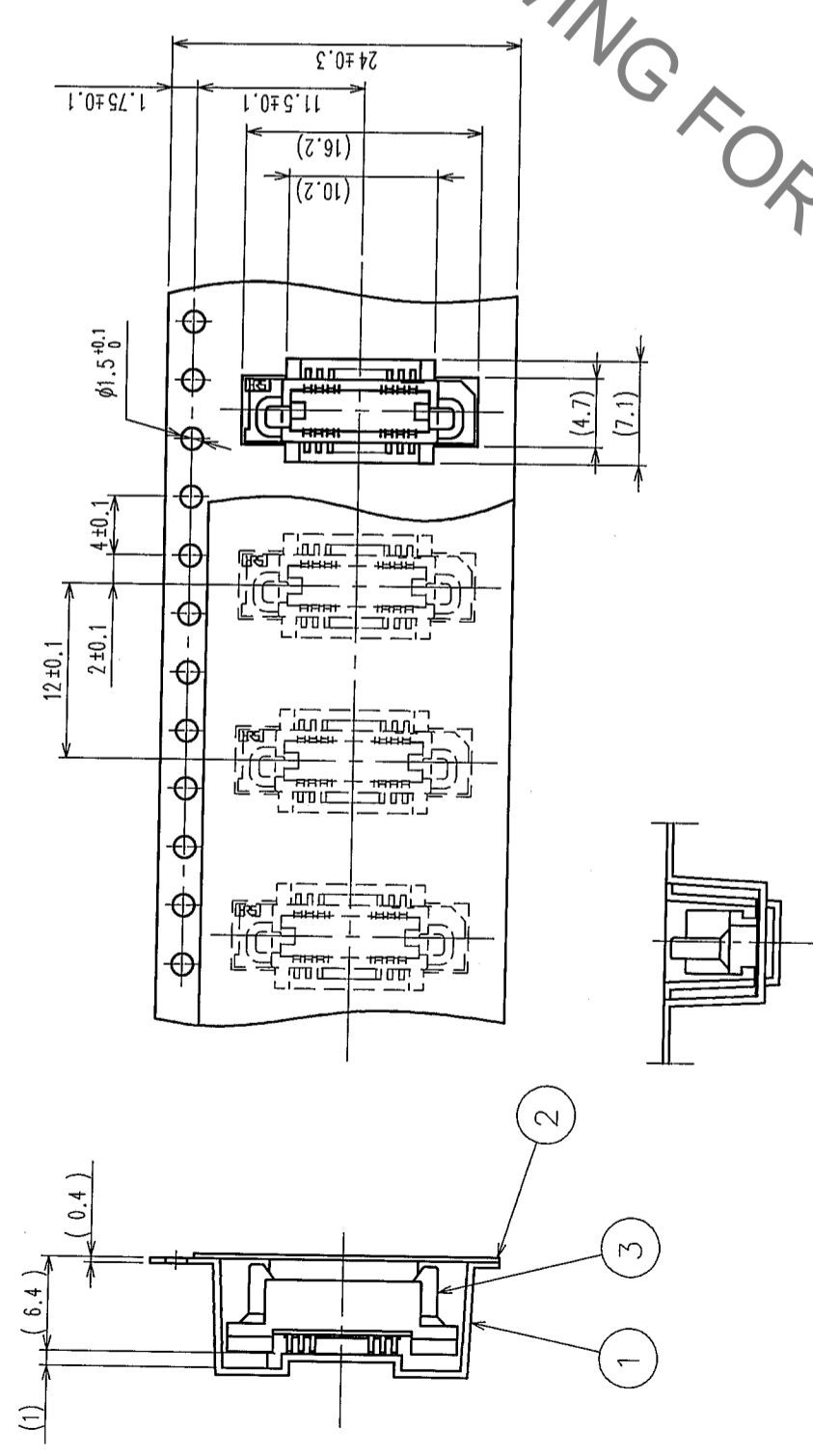
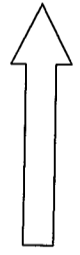

STYLE AND DIMENSION OF REEL (FREE)

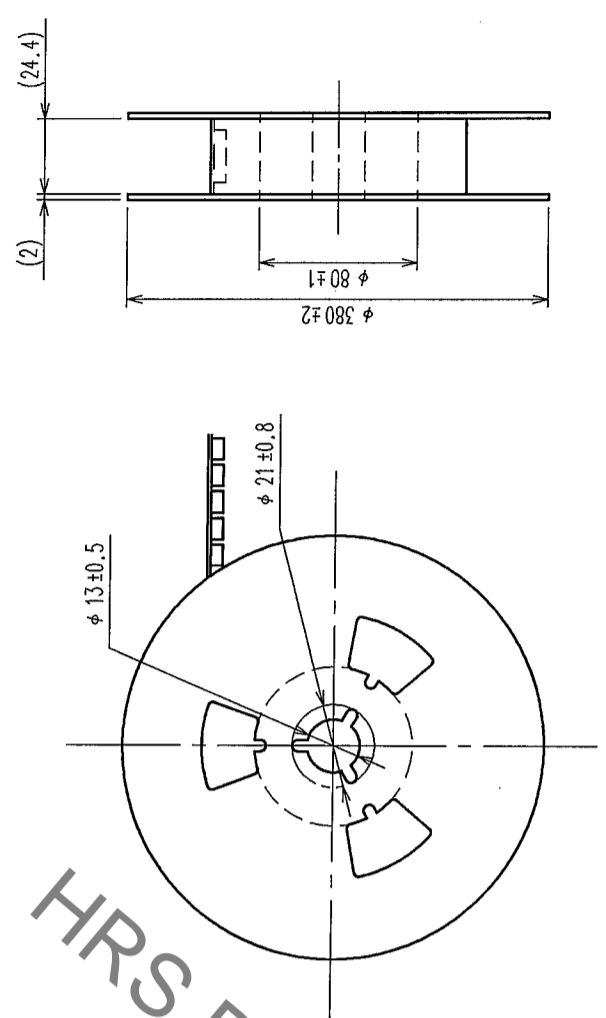

HRS DRAWING FOR REFERENCE

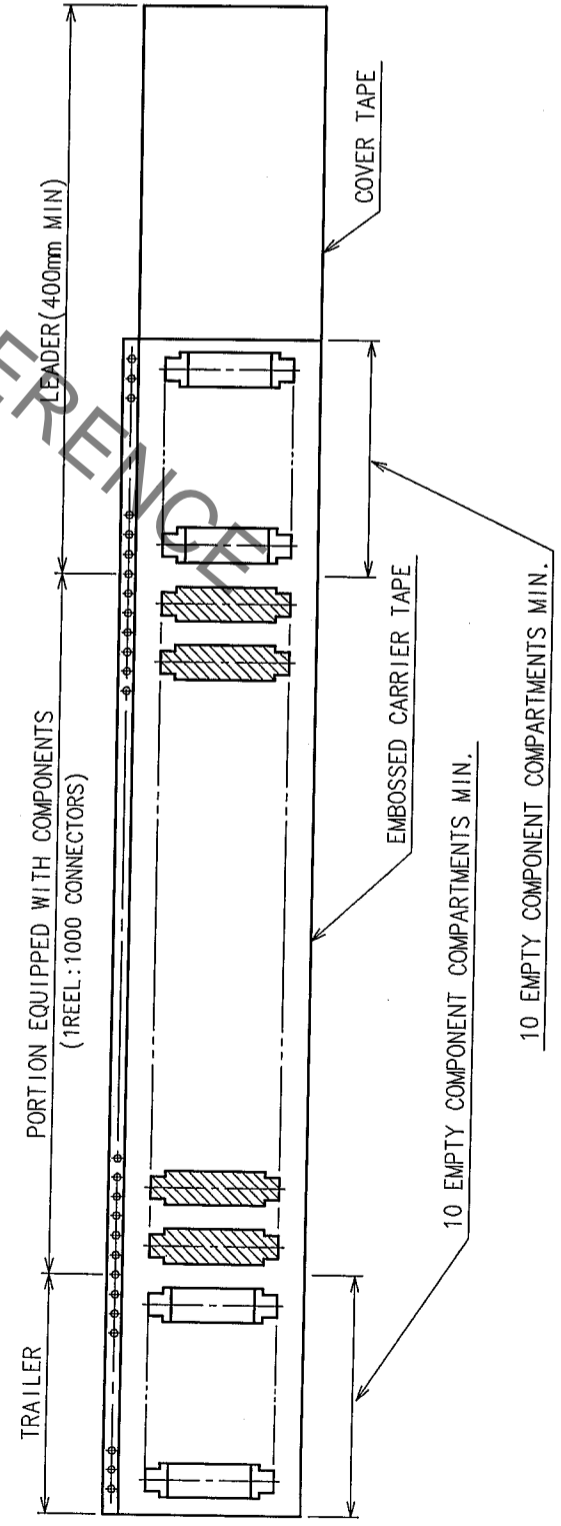

NOTE 1 THE DIMENSIONS IN PARENTHESES ARE FOR REFERENCE.  
2 1 REEL: 1000 CONNECTORS.

NO.	MATERIAL	FINISH, REMARKS	NO.	MATERIAL	FINISH, REMARKS
2	POLYESTER	COVER TAPE	3	(CONNECTOR)	
1	POLYSTYRENE	EMBOSSED CARRIER TAPE			

CODE NO. (OLD)	CL	DRAWN	DESIGNED	CHECKED	APPROVED	RELEASED
		Y. AOYAGI	J. Noda	K. Ogawa	H. Okawa	
		'05.09.15	'05.09.26	'05.09.26	'05.09.26	

DRAWING NO.	PART NO.
EDC3-071315-22	FX6A-20P-0.8SV1(92)

SCALE	UNITS	CODE NO.
2 : 1	mm	CL576-0221-0-92

TO

# Mouser Electronics

Authorized Distributor

Click to View Pricing, Inventory, Delivery & Lifecycle Information:

[Hirose Electric:](#)

[FX6A-20P-0.8SV1\(92\)](#)