

In case of consideration for using Automotive equipment / device which demand high reliability, kindly contact our sales window

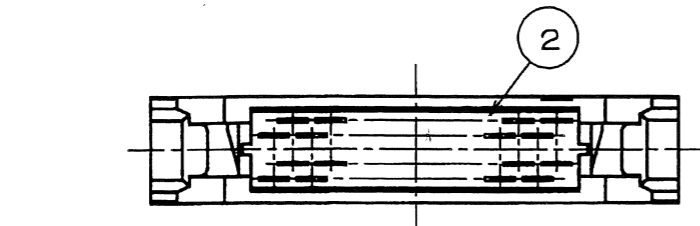

ASSEMBLY DRAWING

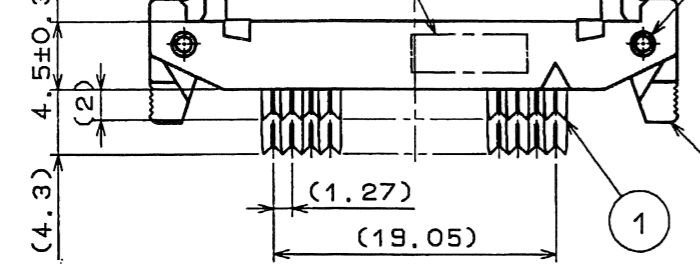
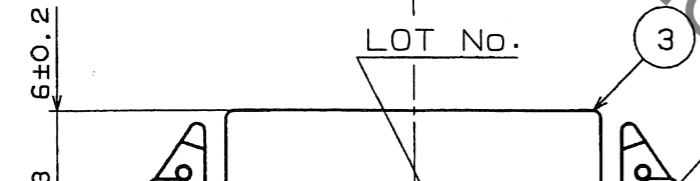
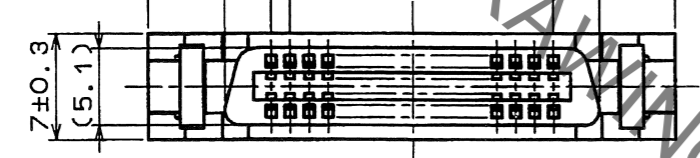
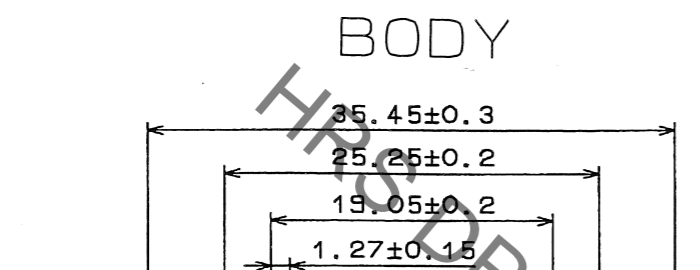
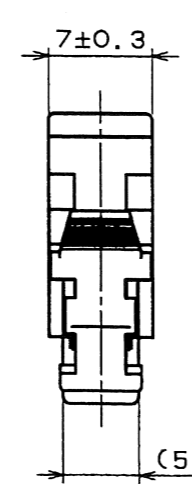
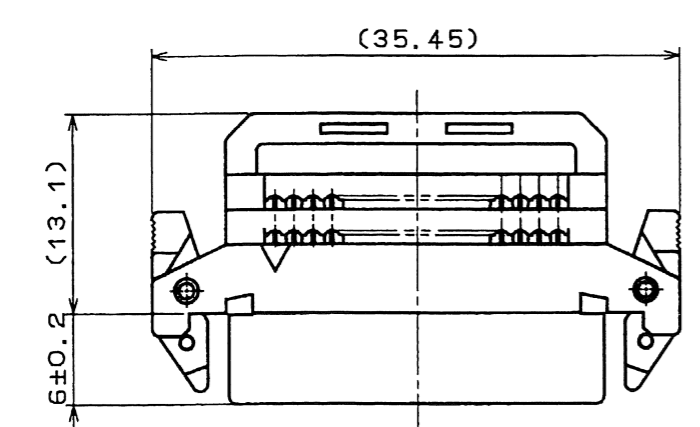
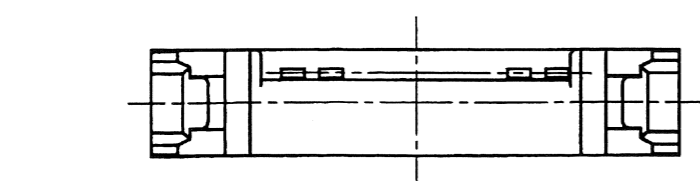

PROTECTOR(A)

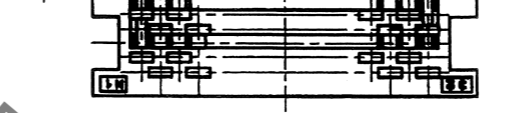
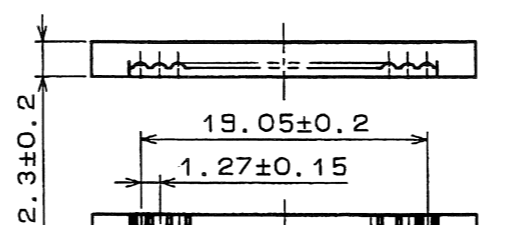
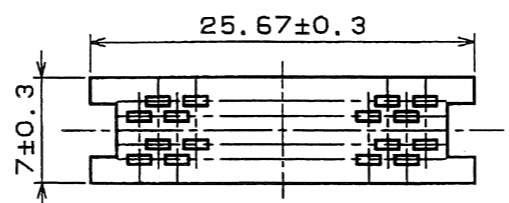

CABLE CLAMP

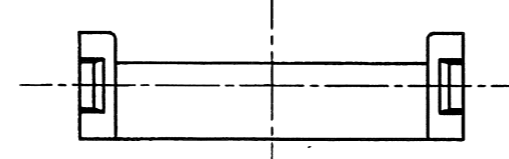
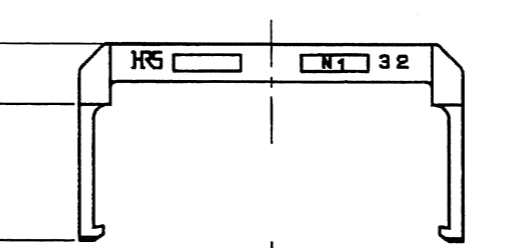
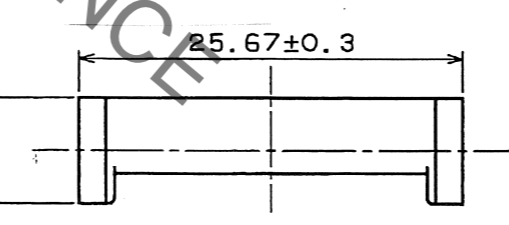

PROTECTOR(B)

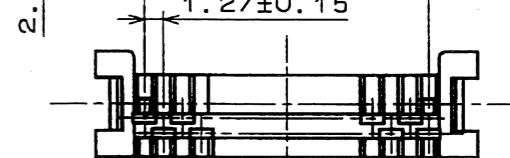
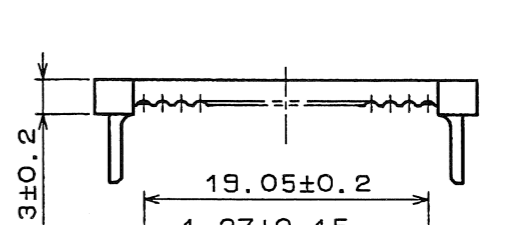
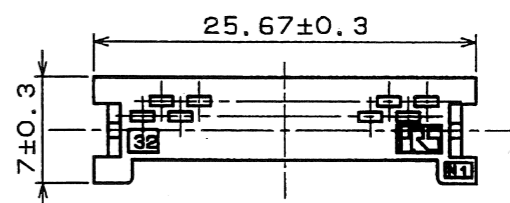

NOTE COMPONENTS OF REF. No. ⑥ TO ⑧ ARE APPENDED PRODUCTS.

NO.	MATERIAL	FINISH . REMARKS
8	POLYAMIDE	BLACK, UL94V-0
7	PBT	BLACK, UL94V-0
6	PBT	BLACK, UL94V-0
5	STAINLESS STEEL	
4	PBT	BLACK, UL94V-0
3	PBT	BLACK, UL94V-0
2	PBT	BLACK, UL94V-0
1	PHOSPHOR BRONZE	CONTACT: GOLD PLATING 0.03μm MIN UNDER :NICKEL PLATING 1μm MIN

UNITS	SCALE	COUNT	DESCRIPTION OF REVISIONS	DESIGNED	CHECKED	DATE
mm	FREE	△				
APPROVED : N. NAKATA 16.11.01			DRAWING NO. EDC-151997-00-00			
CHECKED : HT. YAMAGUCHI 16.11.01			PART NO. FX2BN1-32SA-1.27R			
DESIGNED : MT. ITANO 16.11.01			CODE NO. CL572-0990-9-00			
DRAWN : MT. ITANO 16.11.01						



Mouser Electronics

Authorized Distributor

Click to View Pricing, Inventory, Delivery & Lifecycle Information:

[Hirose Electric:](#)

[FX2BN1-32SA-1.27R](#)