

Sep.1.2021 Copyright 2021 HIROSE ELECTRIC CO., LTD. All Rights Reserved.
In case of consideration for using Automotive equipment / device which demand high reliability, kindly contact our sales window correspondents.

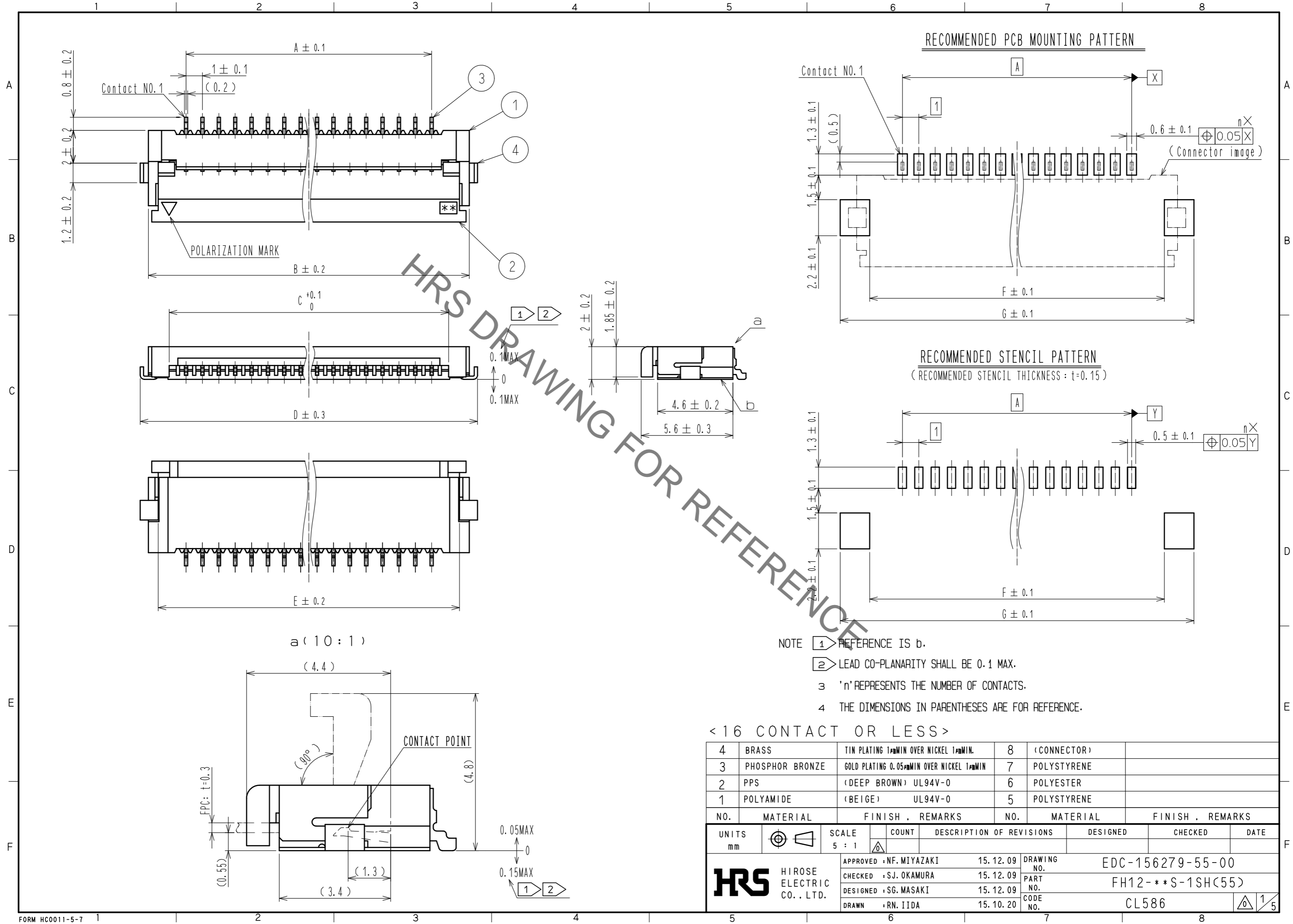

Sep.1.2021 Copyright 2021 HIROSE ELECTRIC CO., LTD. All Rights Reserved.
 In case of consideration for using Automotive equipment / device which demand high reliability, kindly contact our sales window correspondents.

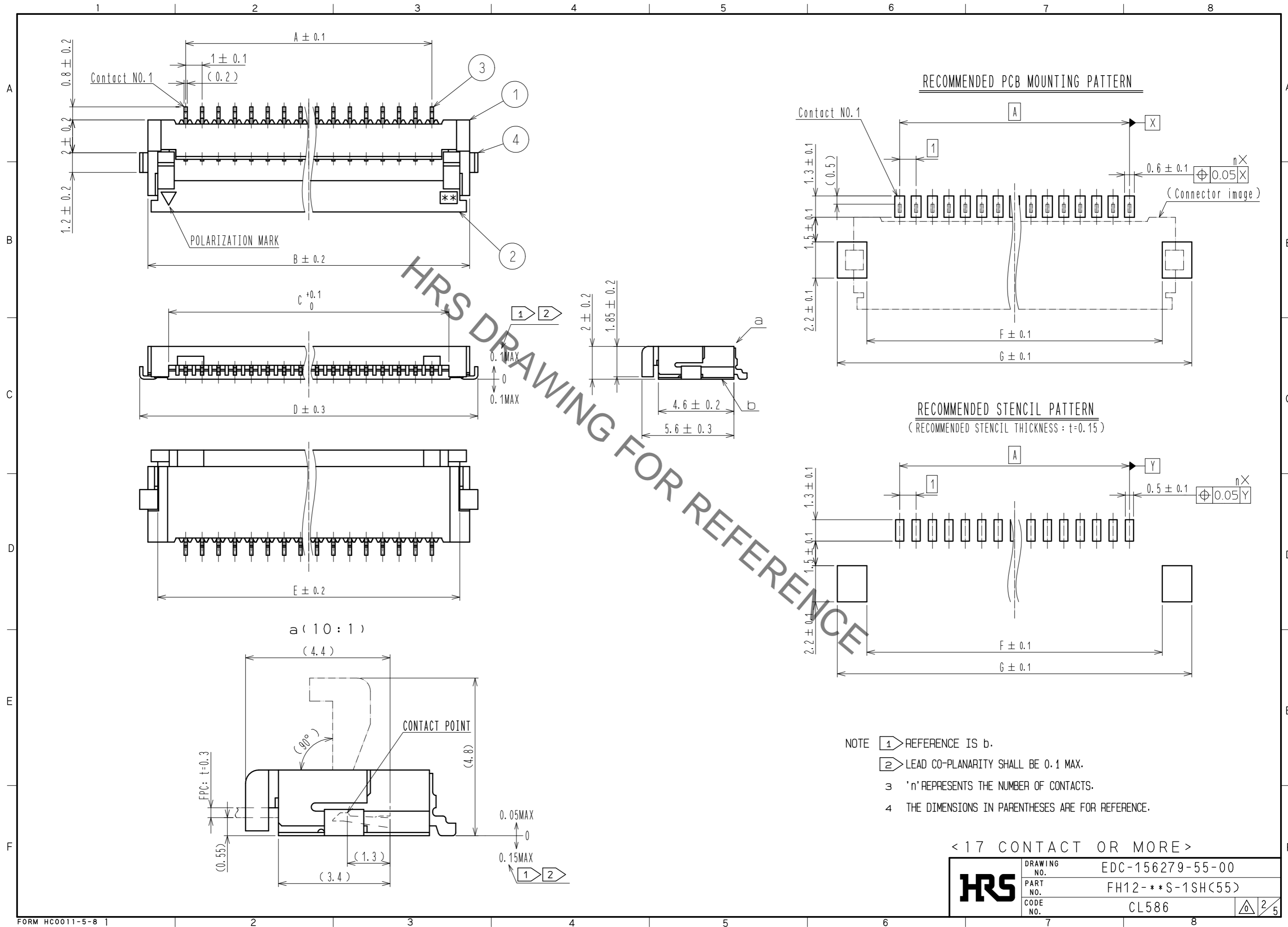

Sep.1.2021 Copyright 2021 HIROSE ELECTRIC CO., LTD. All Rights Reserved.
In case of consideration for using Automotive equipment / device which demand high reliability, kindly contact our sales window correspondents.

RECOMMENDED FPC/FFC (15:1)

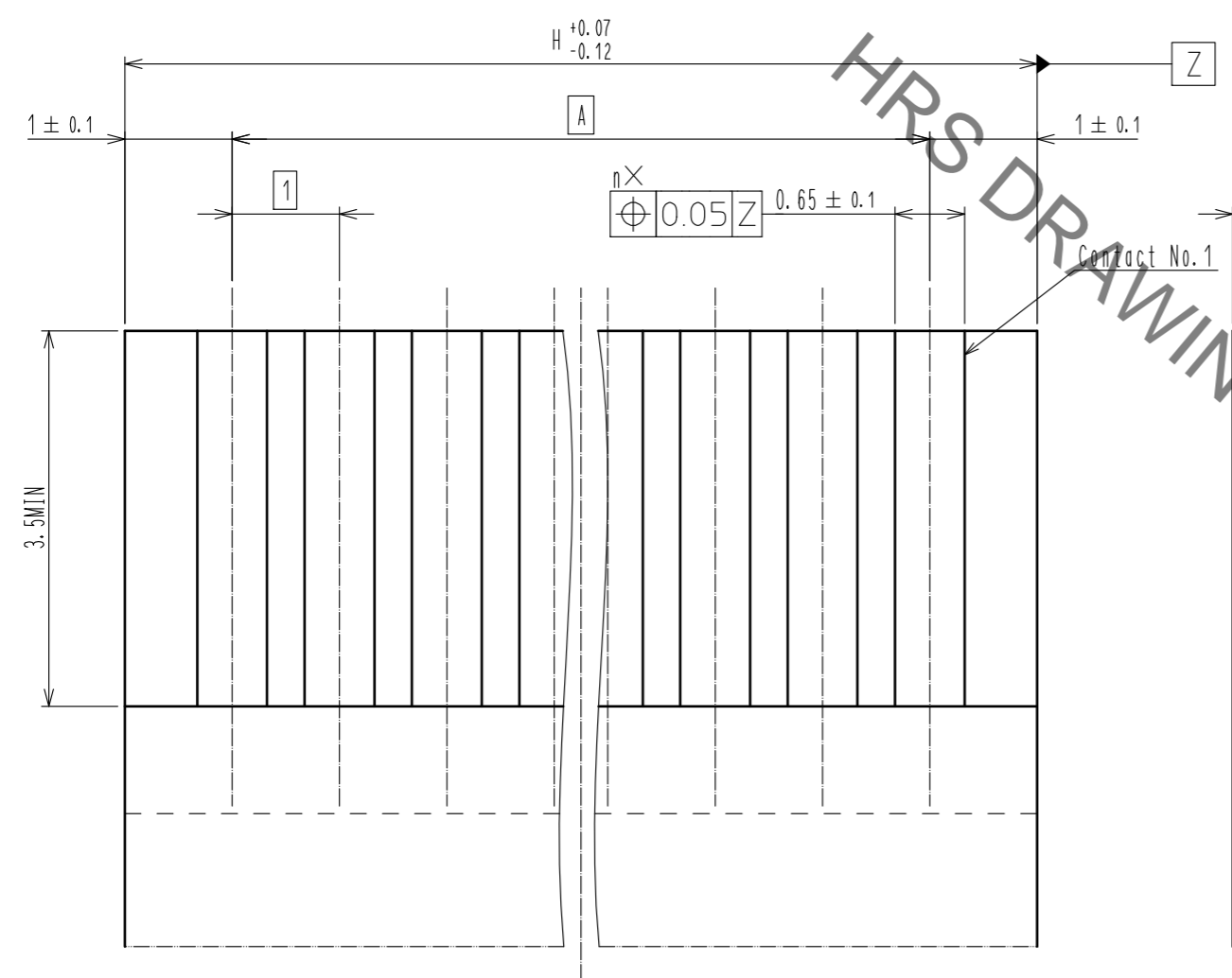

5 THICKNESS OF SUPPORTING TAPE SHALL BE 0.188(7.5MIL) MIN.

FPC CONFIGURATION (REFERENCE EXAMPLE) (SCALE:FREE)

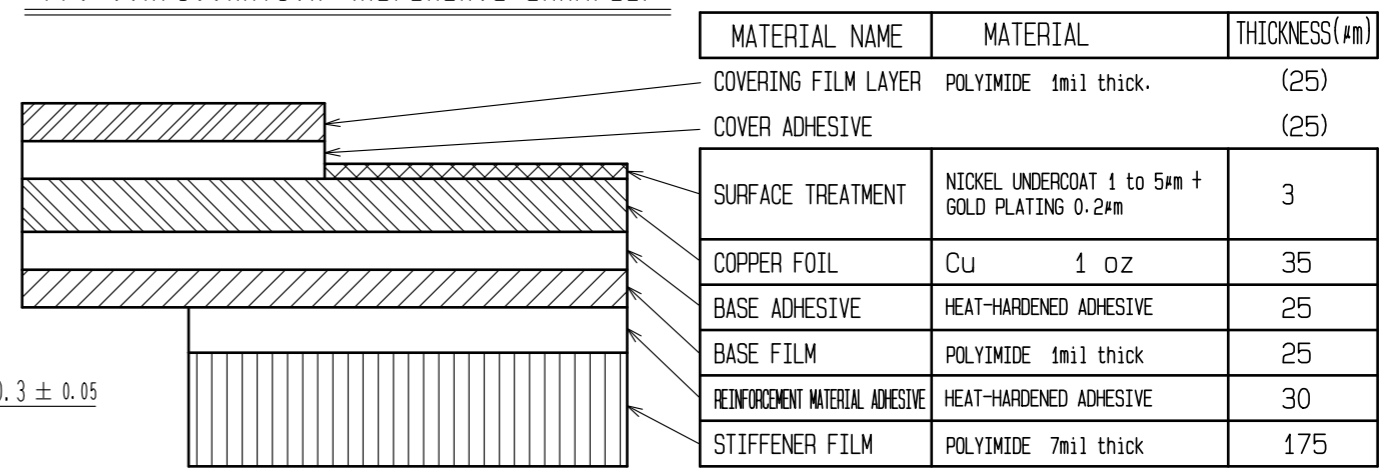

MATERIAL NAME	MATERIAL	THICKNESS(μm)
COVERING FILM LAYER	POLYIMIDE 1mil thick.	(25)
COVER ADHESIVE		(25)
SURFACE TREATMENT	NICKEL UNDERCOAT 1 to 5μm + GOLD PLATING 0.2μm	3
COPPER FOIL	Cu 1 oz	35
BASE ADHESIVE	HEAT-HARDENED ADHESIVE	25
BASE FILM	POLYIMIDE 1mil thick	25
REINFORCEMENT MATERIAL ADHESIVE	HEAT-HARDENED ADHESIVE	30
STIFFENER FILM	POLYIMIDE 7mil thick	175

FFC CONFIGURATION (REFERENCE EXAMPLE) (SCALE:FREE)

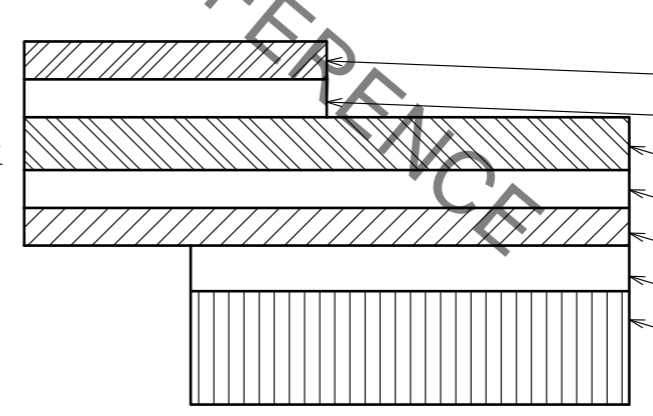

MATERIAL NAME	MATERIAL	THICKNESS(μm)
POLYESTER FILM		(12)
ADHESIVE	THERMOPLASTIC POLYESTER	(30)
GOLD PLATED SOFT COPPER FILM		35
ADHESIVE	POLYESTER	30
POLYESTER		12
ADHESIVE	POLYESTER	30
STIFFENER FILM	POLYESTER	188

HRS	DRAWING NO.	EDC-156279-55-00
	PART NO.	FH12-**-S-1SH(55)
	CODE NO.	CL586

3/5

Sep.1.2021 Copyright 2021 HIROSE ELECTRIC CO., LTD. All Rights Reserved.
 In case of consideration for using Automotive equipment / device which demand high reliability, kindly contact our sales window correspondents.

EMBOSSED CARRIER TAPE DIMENSION(2:1)

TAPE WIDTH:32mm MIN

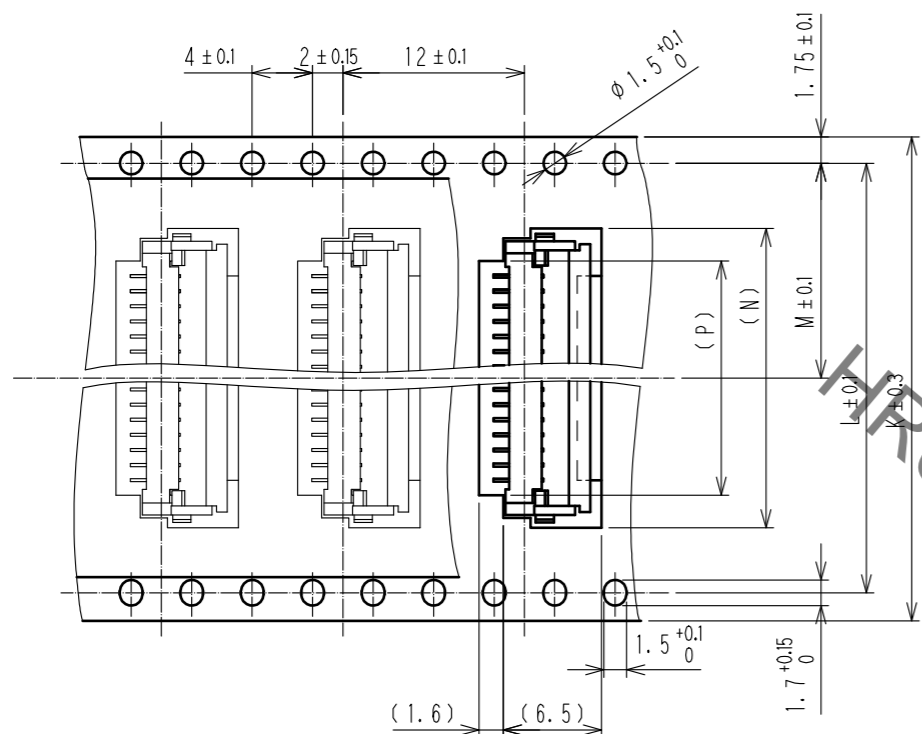

DIRECTION OF UNREELING



TAPE WIDTH:24mm MAX

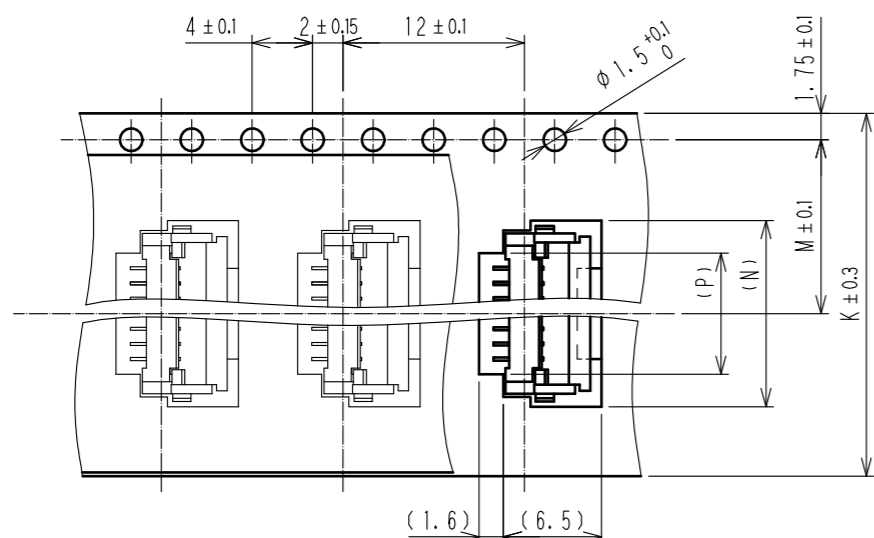

DIRECTION OF UNREELING



REEL DIMENSION (FREE)

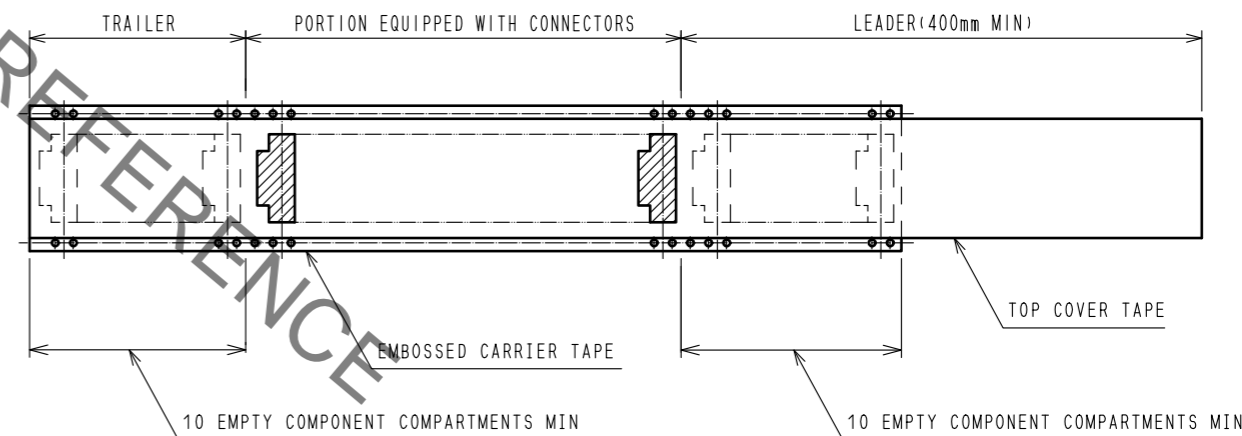
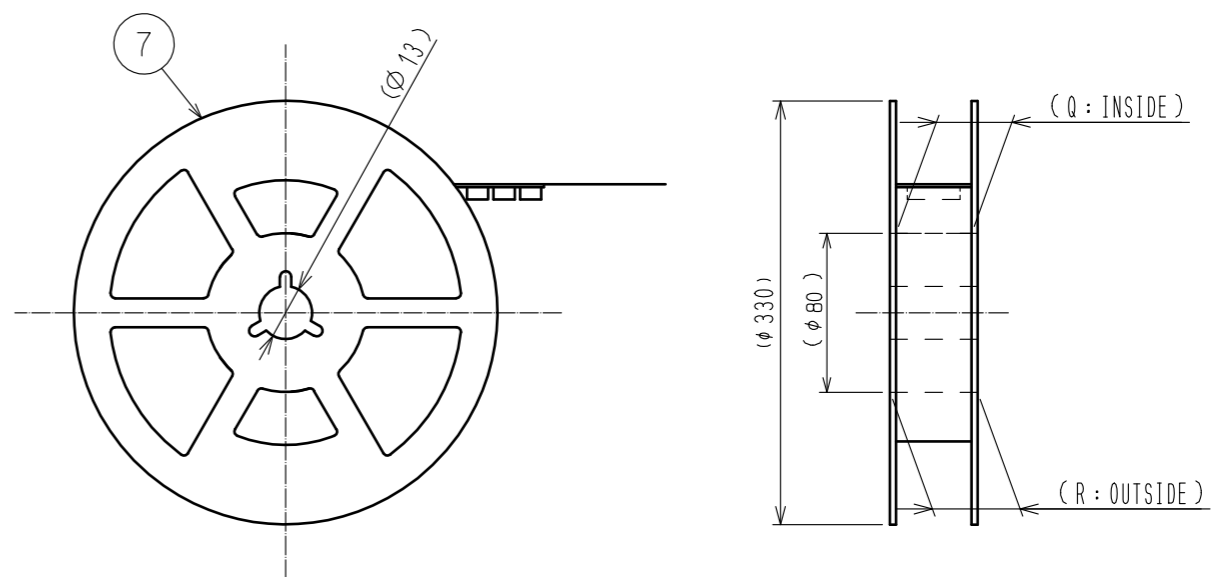

6 PER REEL:2000 CONNECTORS.

7 SEE DIMENSION TABLE IN THE APPENDIX.

<DRAWING FOR PACKING>

HRS	DRAWING NO.	EDC-156279-55-00
	PART NO.	FH12-**-S-1SH(55)
	CODE NO.	CL586
		4/5

Sep.1.2021 Copyright 2021 HIROSE ELECTRIC CO., LTD. All Rights Reserved.
 In case of consideration for using Automotive equipment / device which demand high reliability, kindly contact our sales window correspondents.

PART NO.	CODE NO.	NUMBER OF CONTACT	DIMENSION TABLE OF CONNECTOR, FPC, FFC, PCB MOUNTING PATTERN AND STENCIL PATTERN									DIMENSION TABLE OF DRAWING FOR PACKING					
			A	B	C	D	E	F	G	H	K	L	M	N	P	Q	R
FH12- 5S-1SH(55)	CL586-0591-6-55	5	4	8.6	6.07	9.6	7.4	7	10.6	6	16	—	7.5	10.3	6	17.4	21.4
FH12- 6S-1SH(55)	CL586-0607-4-55	6	5	9.6	7.07	10.6	8.4	8	11.6	7	24	—	11.5	11.3	7	25.4	29.4
FH12- 7S-1SH(55)	CL586-0535-5-55	7	6	10.6	8.07	11.6	9.4	9	12.6	8	24	—	11.5	12.3	8	25.4	29.4
FH12- 8S-1SH(55)	CL586-0579-0-55	8	7	11.6	9.07	12.6	10.4	10	13.6	9	24	—	11.5	13.3	9	25.4	29.4
FH12- 9S-1SH(55)	CL586-0540-5-55	9	8	12.6	10.07	13.6	11.4	11	14.6	10	24	—	11.5	14.3	10	25.4	29.4
FH12- 11S-1SH(55)	CL586-0668-9-55	11	10	14.6	12.07	15.6	13.4	13	16.6	12	24	—	11.5	16.3	12	25.4	29.4
FH12- 12S-1SH(55)	CL586-0741-7-55	12	11	15.6	13.07	16.6	14.4	14	17.6	13	24	—	11.5	17.3	13	25.4	29.4
FH12- 16S-1SH(55)	CL586-0536-8-55	16	15	19.6	17.07	20.6	18.4	18	21.6	17	32	28.4	14.2	21.3	17	33.4	37.4
FH12- 17S-1SH(55)	CL586-0739-5-55	17	16	20.6	18.07	21.6	19.4	19	22.6	18	44	40.4	20.2	22.3	18	45.4	49.4
FH12- 22S-1SH(55)	CL586-0547-4-55	22	21	25.6	23.07	26.6	24.4	24	27.6	23	44	40.4	20.2	27.3	23	45.4	49.4
FH12- 26S-1SH(55)	CL586-0592-9-55	26	25	29.6	27.07	30.6	28.4	28	31.6	27	44	40.4	20.2	31.3	27	45.4	49.4

HRS DRAWING FOR REFERENCE

HRS	DRAWING NO.	EDC-156279-55-00
	PART NO.	FH12- **S-1SH(55)
	CODE NO.	CL586
		5/5

Mouser Electronics

Authorized Distributor

Click to View Pricing, Inventory, Delivery & Lifecycle Information:

[Hirose Electric:](#)

[FH12-7S-1SH\(55\)](#)