

May.1.2024 Copyright 2024 HIROSE ELECTRIC CO., LTD. All Rights Reserved.
In case of consideration for using Automotive equipment / device which demand high reliability, kindly contact our sales window correspondents.

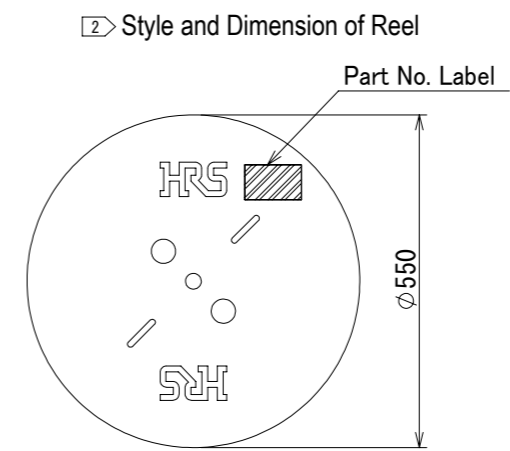
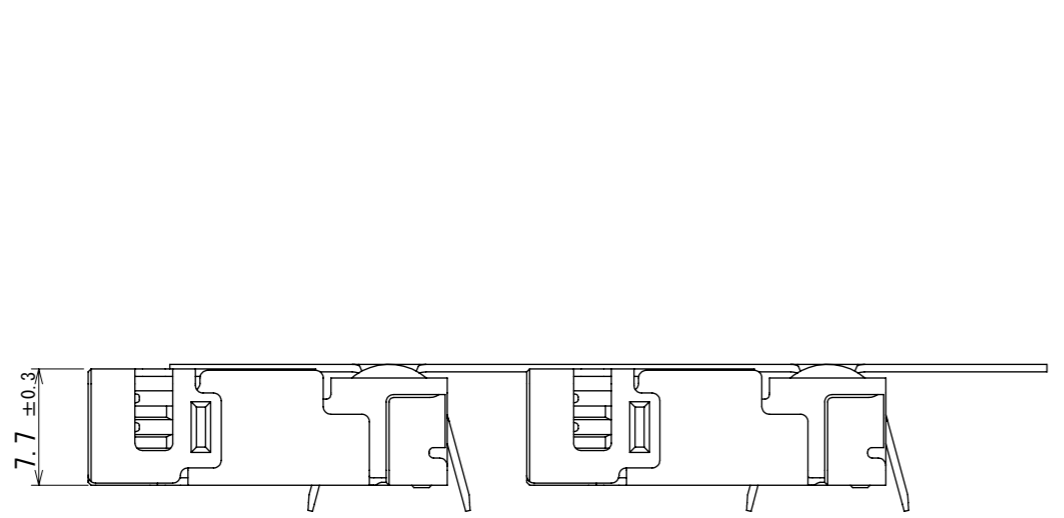

Detail of part No. Label

HRS		検査
品名コード	CL680-3081-0	Inspection
品名	DF60S-8SCFA	
数量	700	
仕様		
LOT No.		
継ぎ目		

Section
Lot No.
Specification
Quantity
Part No.
Code No.

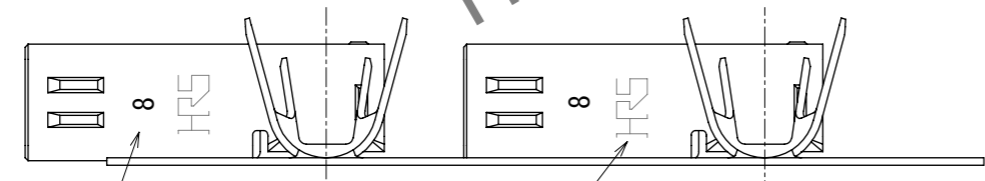
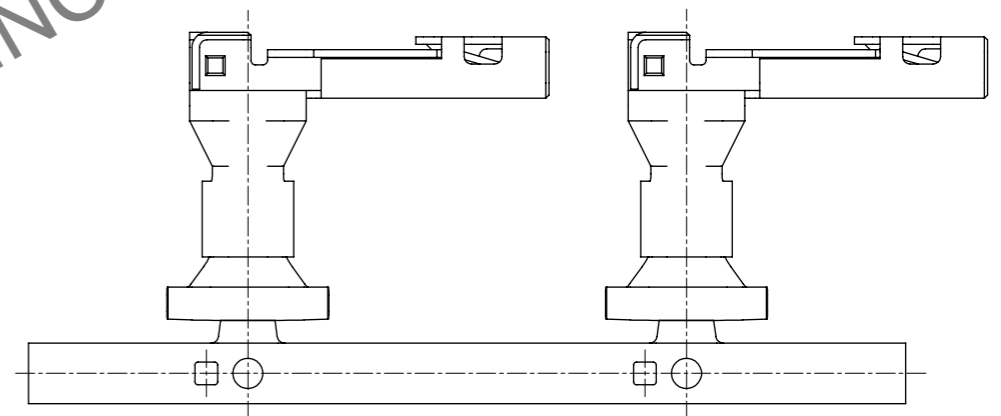
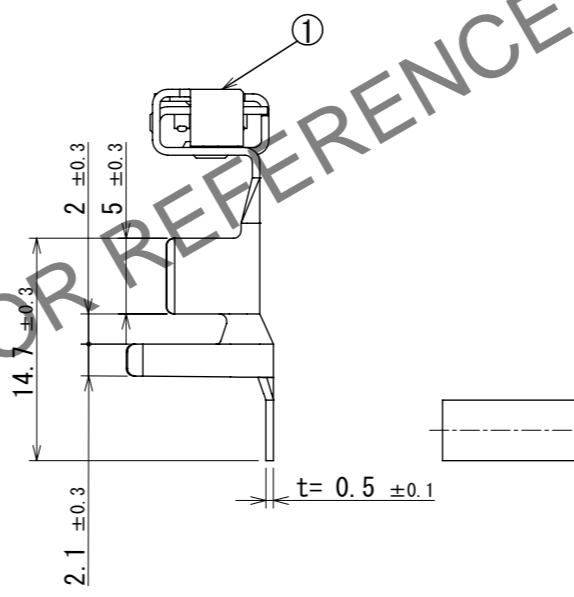
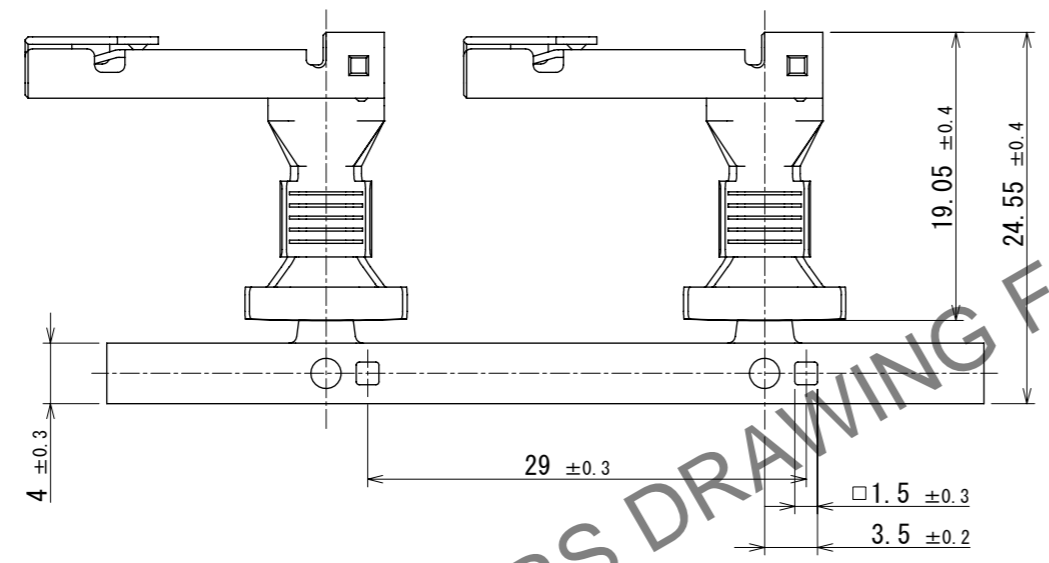
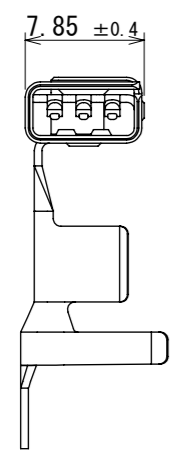

HRS DRAWING FOR REFERENCE

- Note 1. 1RL:700 Contacts.
 ② Style of reel shows in figure.
 3. Please make sure to check the form of crimping using a cable in adjusting an applicator.
 4. Applicable cable is 8 AWG.
 5. Refer to the technical specification (ETAP-H1184-00) for the packing type.
 ⚠ 6. Please refer to the technical specification (ETAD-H0654-00, ETAD-H0653-00, ETAD-H1042-00) for handling.

1	Copper alloy	Contact area : Au plating 0.2μm min Wire barrel area : Sn plating 1 μm min Under plating : Ni plating 1 μm min
NO.	MATERIAL	FINISH , REMARKS

UNITS mm		SCALE 2:1	COUNT 1	DESCRIPTION OF REVISIONS DIS-H-00019384	DESIGNED SN. MIWA	CHECKED TT. OHSAKO	DATE 2023. 10. 31
HRS HIROSE ELECTRIC CO., LTD.		APPROVED : SJ. OKAMURA	2023. 10. 19	DRAWING NO.	EDC-402083-00-00		
		CHECKED : TT. OHSAKO	2023. 10. 19	PART NO.	DF60S-8SCFA		
		DESIGNED : KT. NUMATA	2023. 10. 18	CODE NO.	CL0680-3081-0-00		
		DRAWN : SK. CHIBA	2023. 10. 18				

Mouser Electronics

Authorized Distributor

Click to View Pricing, Inventory, Delivery & Lifecycle Information:

[Hirose Electric:](#)

[DF60S-8SCFA](#)