

Aug.1.2021 Copyright 2021 HIROSE ELECTRIC CO., LTD. All Rights Reserved.
In case of consideration for using Automotive equipment / device which demand high reliability, kindly contact our sales window correspondents.

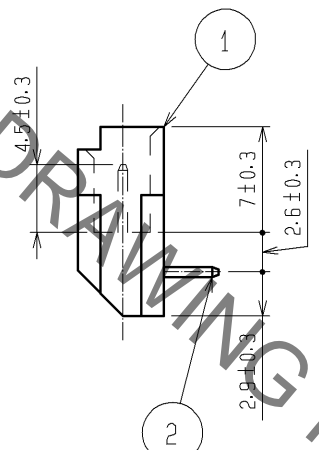

RECOMMENDED PATTERN(5:1)

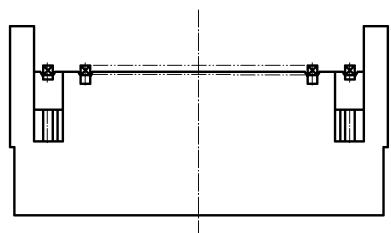
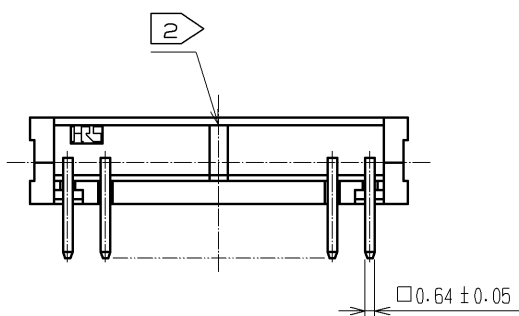
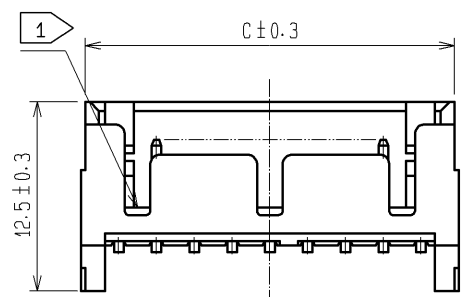
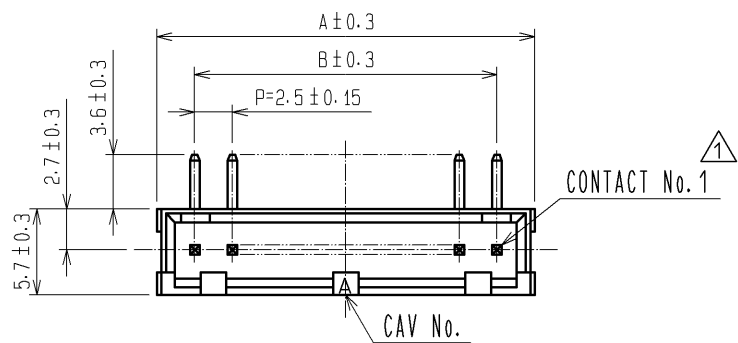
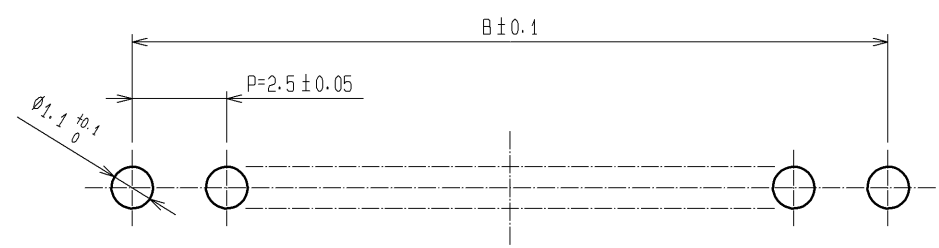

HRS DRAWING FOR REFERENCE

CODE NO.	PART NO.	CONTACT	A	B	C
CL541-2034-0-00	DF1BZ- 2P-2.5DS	2	7.5	2.5	6.9
CL541-2035-2-00	DF1BZ- 3P-2.5DS	3	10.0	5.0	9.4
CL541-2036-5-00	DF1BZ- 4P-2.5DS	4	12.5	7.5	11.9
CL541-2037-8-00	DF1BZ- 5P-2.5DS	5	15.0	10.0	14.4
CL541-2038-0-00	DF1BZ- 6P-2.5DS	6	17.5	12.5	16.9
CL541-2039-3-00	DF1BZ- 7P-2.5DS	7	20.0	15.0	19.4
CL541-2040-2-00	DF1BZ- 8P-2.5DS	8	22.5	17.5	21.9
CL541-2041-5-00	DF1BZ- 9P-2.5DS	9	25.0	20.0	24.4
CL541-2042-8-00	DF1BZ-10P-2.5DS	10	27.5	22.5	26.9
CL541-2043-0-00	DF1BZ-11P-2.5DS	11	30.0	25.0	29.4
CL541-2044-3-00	DF1BZ-12P-2.5DS	12	32.5	27.5	31.9
CL541-2045-6-00	DF1BZ-13P-2.5DS	13	35.0	30.0	34.4
CL541-2046-9-00	DF1BZ-14P-2.5DS	14	37.5	32.5	36.9
CL541-2047-1-00	DF1BZ-15P-2.5DS	15	40.0	35.0	39.4
CL541-2048-4-00	DF1BZ-16P-2.5DS	16	42.5	37.5	41.9
CL541-2049-7-00	DF1BZ-18P-2.5DS	18	47.5	42.5	46.9
CL541-2050-6-00	DF1BZ-20P-2.5DS	20	52.5	47.5	51.9

NOTES ①: FOR 2 AND 3 CONTACTS, ONE MIS-INSERTION DEPRESSION SHALL BE MADE, AND 4 TO 7 CONTACTS IS 2 MIS-INSERTION DEPRESSION TO BOTH ENDS, FOR OTHER, 3 MIS-INSERTION DEPRESSION AS PER DRAWING.
②: WHEN THE NUMBERS OF CONTACTS IS ODD, THE STAND-OFF SHIFTS 1.25 RIGHTWARD. (STAND-OFF AVAILABLE FROM 5 POSITIONS UP.)

1	POLYAMIDE	UL94V-0, NATURAL(WHITE)	2	BRASS	SURFACE:TIN PLATED 1μm min UNDER PLATING:NICKEL PLATED 0.5μm min		
NO.	MATERIAL	FINISH, REMARKS	NO.	MATERIAL	FINISH, REMARKS		
UNITS mm		SCALE 5:1	COUNT 1	DESCRIPTION OF REVISIONS DIS-H-002720	DESIGNED YK. NAKATSU	CHECKED HK. UMEHARA	DATE 08.01.15
HRS HIROSE ELECTRIC CO., LTD.		APPROVED : KJ. KATAYOSE	05.01.05	DRAWING NO. EDC3-305814-01			
		CHECED : TY. OMA	05.01.05	PART NO. DF1BZ-*P-2.5DS			
		DESIGNED : TS. KUMAZAWA	05.01.05	CODE NO. CL541-			
		DRAWN : TS. KUMAZAWA	05.01.05				

Mouser Electronics

Authorized Distributor

Click to View Pricing, Inventory, Delivery & Lifecycle Information:

[Hirose Electric:](#)

[DF1BZ-18P-2.5DS](#)