

# DBL13W3P700G30LF

## REFERENCE SPECIFICATIONS

-NFC 93425 (in compliance with HE 507)

## PHYSICAL CHARACTERISTICS

- INSULATOR MATERIAL: THERMOPLASTIC UL94V0
- CONTACT MATERIAL: BRASS(SIGNAL CONTACT)  
BRASS (POWERS CONTACT)
- ACCESSORIES: BRASS
- SHELLS: STEEL

## ELECTRICAL CHARACTERISTICS

- NOMINAL CURRENT: 7.5A (SIGNAL CONTACT)  
30A (POWER CONTACT)
- CONTACT RESISTANCE: <=7.3 m Ohms(SIGNAL and POWER)
- CONTACT/CONTACT : >=1000 V
- CONTACT/GROUND : >=1200 V
- INSULATION RESISTANCE: >=5000 MOhms

## CLIMATIC CATEGORY: 55/125/21

TEMPERATURE RANGE -55°C TO +125°C  
DAMP HEAT STEADY STATE 21 DAYS  
SALT SPRAY 48 HOURS

- RETENTION AGAINST TORQUE: - Threaded insert: 0.7 N.m minimum  
- Female screw : 0.5 N.m minimum

Series

Shell size: **A B C**  
see sheet 3

Front accessory definition  
see sheet 2

- blank** :without accessory
- L** :threaded insert M3
- O** :threaded insert UNC 4-40
- V** :female screw UNC 4-40

Layout of contacts (see sheets)

Contacts

**P** :Pin

Termination type

**7** Right angle/USA

Plating

- 00** 200 matings/unmatings
- 43** 500 matings/unmatings

PCB accessories definition  
see sheet 2

- A** :without accessory
- H** :Metal brackets+harpoons for PCB 2.40mm
- G** :Metal brackets+harpoons for PCB 1.60mm
- M** :Metal brackets

Power contacts

- 00** :Not fitted with power contact (signal contacts always fitted)
- 30** :Fitted with power contacts 30 Amp.

See note RoHS

## NOTE RoHS INFORMATION

- The "LF" products meet european union Directives and other country regulations as described in GS-22-008.
- The housing will withstand exposure to 260°C peak temperature for 3.5 seconds in a wave solder application with a 1.6mm minimum thick circuit board. See application notes/procedures if they are available.
- Termination plating spec:
  - Signal contacts: Ni + Gold
  - Power contacts: Ni 1.27µm+Sn 2.5 to 7.5µm,pure bright
- Active area plating spec:
  - Signal and power contacts: Ni + Gold
- Shell plating :2 to 4µm Cu + Ni + 3 to 10µm Sn,pure bright
- Accessories: Sn pure bright + Nickel
- Packaging spec: See GS-14-920

TABLE 1:PCB HOLE DIAMETERS

	POWER CONTACTS		ACCESSORIES	SIGNAL CONTACTS
30 A	2.00	∅2.40	∅3.10	∅0.90 min
Max current power	∅A <sup>+0.1</sup> <sub>0</sub>	PCB HOLE +/-0.1	PCB HOLE +/-0.1	PCB HOLE +/-0.1

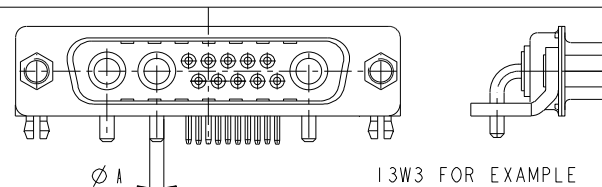

www.fciconnect.com		surface	tolerance std	projection	mm
		ISO 1302	ISO 406 ISO 1101		
TOLERANCES UNLESS OTHERWISE SPECIFIED					
Dr	M PESSON	2005-10-11	ANGULAR	size	Scale
Eng	P LEGARE	2005-10-11	LINEAR	A2	2:1
Chr			0.X	∅.3	
			0.XX	∅.1	
			0.XXX	∅.05	ECN F09-0092
Appr					Spec ref
Product family					

rev	ecn no	dr	date
A	LS05-0101	MPE	2005-10-11
B	LS06-0208	LGO	2006-12-12
C	LS07-0273	MPE	2007/10/31
D	F09-0092	LSA	2009/09/16

FCI TITLE SUB MALE DW US foot print  
mixed power right angled solder

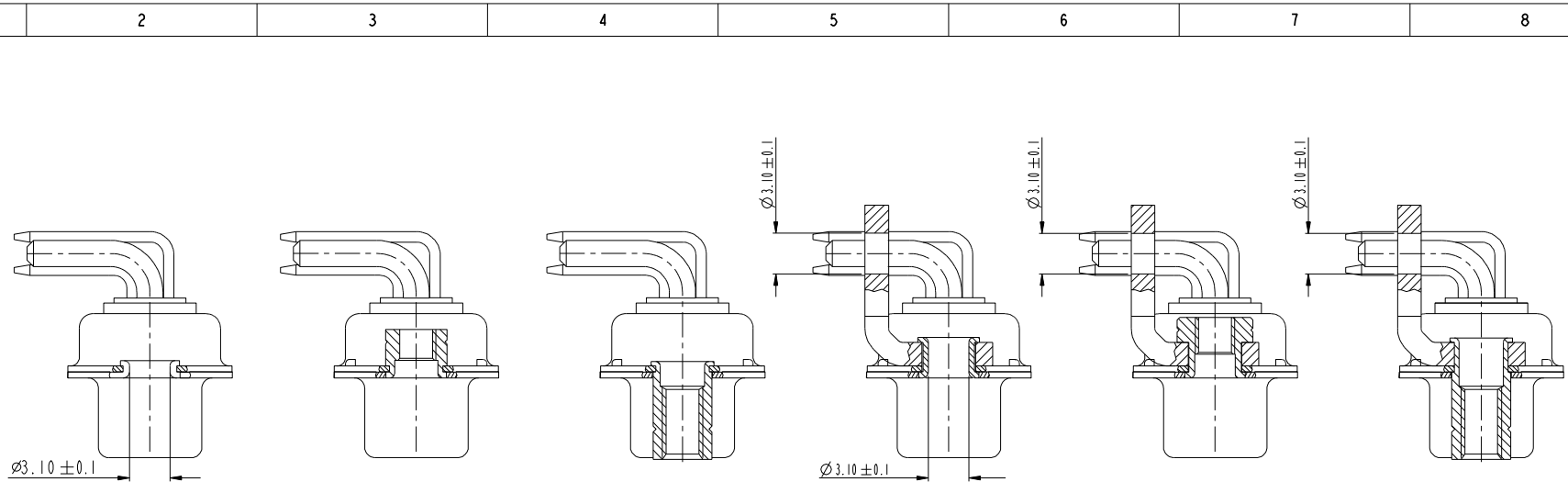

FRONT ACCESSORY	<b>Blank</b> Without	<b>L</b> insert M3 <b>O</b> insert UNC 4.40	<b>V</b> insert UNC 4.40	<b>Blank</b> Without	<b>L</b> insert M3 <b>O</b> insert UNC 4.40	<b>V</b> insert UNC 4.40
PCB ACCESSORIES	<b>A</b> Without	<b>A</b> Without	<b>A</b> Without	<b>M</b> Metal brackets	<b>M</b> Metal brackets	<b>M</b> Metal bracket

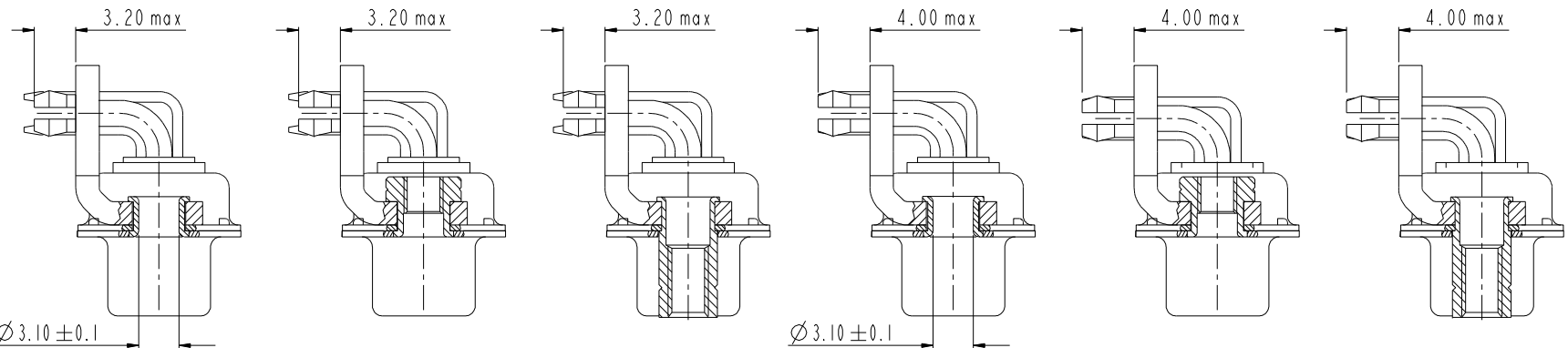

FRONT ACCESSORY	<b>Blank</b> Without	<b>L</b> insert M3 <b>O</b> insert UNC 4.40	<b>V</b> insert UNC 4.40	<b>Blank</b> Without	<b>L</b> insert M3 <b>O</b> insert UNC 4.40	<b>V</b> insert UNC 4.40
PCB ACCESSORIES	<b>G</b> Metal brackets + harpoons for PCB 1.60mm	<b>G</b> Metal brackets + harpoons for PCB 1.60mm	<b>G</b> Metal brackets + harpoons for PCB 1.60mm	<b>H</b> Metal brackets + harpoons for PCB 2.40mm	<b>H</b> Metal brackets + harpoons for PCB 2.40mm	<b>H</b> Metal brackets + harpoons for PCB 2.40mm

www.fciconnect.com		surface ISO 1302	tolerance std ISO 406 ISO 1101	projection mm
TOLERANCES UNLESS OTHERWISE SPECIFIED				
Dr	M PESSON	2005-10-11	ANGULAR	size A2
Eng	P LEGARE	2005-10-11	LINEAR	Scale 2:1
Chr			0° ±2°	ECN F09-0092
Appr			Product family	Spec ref

FCI	Sub title	Part no	Rev.
	SUB MALE DW US foot print mixed power right angled solder	C01-8639-2305	D

SCALE: 4

I 2 3 4 5 6 7 8

A  
B  
C  
D  
E  
F

A  
B  
C  
D  
E  
F

PART NUMBER	AMPS	MATINGS/ UNMATINGS	FRONT ACCESSORY	PCB ACCESSORIES
D*xWxP700A30LF	30	200	without	without
D*LxWxP700A30LF	30	200	insert M3	without
D*OxWxP700A30LF	30	200	insert UNC 4.40	without
D*VxWxP700A30LF	30	200	female screw UNC 4.40	without
D*xWxP700H30LF	30	200	without	metal bracket+harpoon PCB 2.40mm
D*LxWxP700H30LF	30	200	insert M3	metal bracket+harpoon PCB 2.40mm
D*OxWxP700H30LF	30	200	insert UNC 4.40	metal bracket+harpoon PCB 2.40mm
D*VxWxP700H30LF	30	200	female screw UNC 4.40	metal bracket+harpoon PCB 2.40mm
D*xWxP700G30LF	30	200	without	metal bracket+harpoon PCB 1.60mm
D*LxWxP700G30LF	30	200	insert M3	metal bracket+harpoon PCB 1.60mm
D*OxWxP700G30LF	30	200	insert UNC 4.40	metal bracket+harpoon PCB 1.60mm
D*VxWxP700G30LF	30	200	female screw UNC 4.40	metal bracket+harpoon PCB 1.60mm
D*xWxP700M30LF	30	200	without	metal bracket
D*LxWxP700M30LF	30	200	insert M3	metal bracket
D*OxWxP700M30LF	30	200	insert UNC 4.40	metal bracket
D*VxWxP700M30LF	30	200	female screw UNC 4.40	metal bracket

shell size \* LAYOUTS  
xWx

A 11W1  
A 7W2  
B 21W1  
B 17W2  
B 13W3  
C 25W3  
C 21WA4  
C 27W2

PART NUMBER	AMPS	MATINGS/ UNMATINGS	FRONT ACCESSORY	PCB ACCESSORIES
D*xWxP743A30LF	30	500	without	without
D*LxWxP743A30LF	30	500	insert M3	without
D*OxWxP743A30LF	30	500	insert UNC 4.40	without
D*VxWxP743A30LF	30	500	female screw UNC 4.40	without
D*xWxP743H30LF	30	500	without	metal bracket+harpoon PCB 2.40mm
D*LxWxP743H30LF	30	500	insert M3	metal bracket+harpoon PCB 2.40mm
D*OxWxP743H30LF	30	500	insert UNC 4.40	metal bracket+harpoon PCB 2.40mm
D*VxWxP743H30LF	30	500	female screw UNC 4.40	metal bracket+harpoon PCB 2.40mm
D*xWxP743G30LF	30	500	without	metal bracket+harpoon PCB 1.60mm
D*LxWxP743G30LF	30	500	insert M3	metal bracket+harpoon PCB 1.60mm
D*OxWxP743G30LF	30	500	insert UNC 4.40	metal bracket+harpoon PCB 1.60mm
D*VxWxP743G30LF	30	500	female screw UNC 4.40	metal bracket+harpoon PCB 1.60mm
D*xWxP743M30LF	30	500	without	metal bracket
D*LxWxP743M30LF	30	500	insert M3	metal bracket
D*OxWxP743M30LF	30	500	insert UNC 4.40	metal bracket
D*VxWxP743M30LF	30	500	female screw UNC 4.40	metal bracket



Copyright FCI.

www.fciconnect.com		surface ISO 1302	tolerance std ISO 406 ISO 1101	projection mm
TOLERANCES UNLESS OTHERWISE SPECIFIED				
Dr	M PESSON	2005-10-11	ANGULAR	size A2
Eng	P LEGARE	2005-10-11	LINEAR	Scale 2:1
Chr			0° ±2°	ECN F09-0092
Appr			Product family	Spec ref

FCI	TITLE	Sub MALE DW US foot print mixed power right angled solder	Part no	C01-8639-2305	Rev.	D
-----	-------	--	---------	---------------	------	---

**LAYOUT AND CONNECTOR DIMENSIONS**  
For PCB hole diameters see table 1 sheet 1

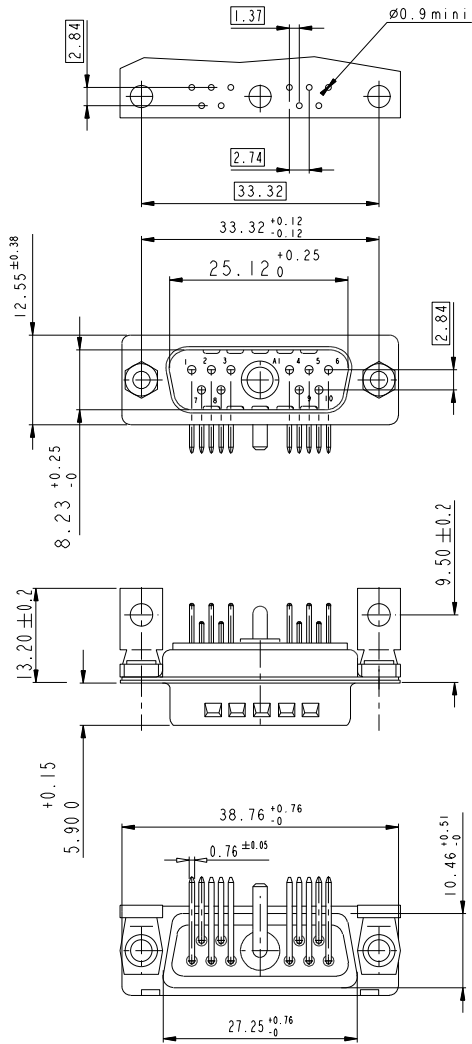

**LAYOUT AND CONNECTOR DIMENSIONS**  
For PCB hole diameters see table 1 sheet 1

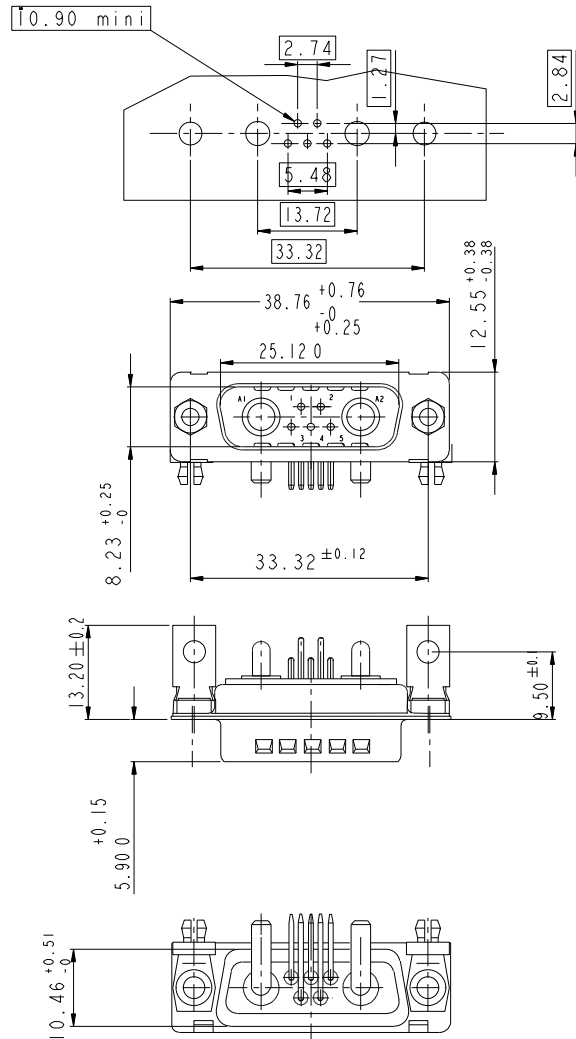

**SIDE VIEW FOR ALL LAYOUTS**

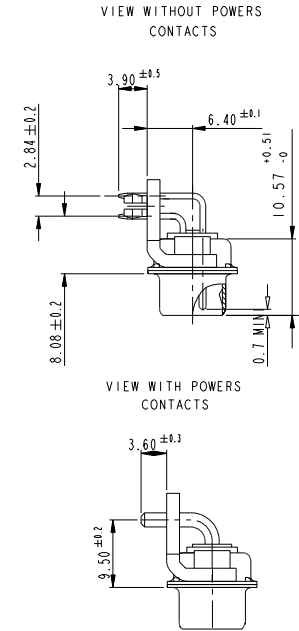

www.fciconnect.com		surface ISO 1302	tolerance std ISO 406 ISO 1101	projection mm
TOLERANCES UNLESS OTHERWISE SPECIFIED				
Dr	M PESSON	2005-10-11	ANGULAR	size A2
Eng	P LEGARE	2005-10-11	LINEAR	Scale 2:1
Chr			0° ±2°	ECN F09-0092
Appr			Product family	Spec ref

FCI	TITLE SUB MALE DW US foot print mixed power right angled solder	ang no C01-8639-2305	Rev. D
-----	---	-------------------------	-----------

1

2

3

4

5

6

7

8

# 13W3

## LAYOUT AND CONNECTOR DIMENSIONS

For PCB hole diameters see table 1 sheet 1

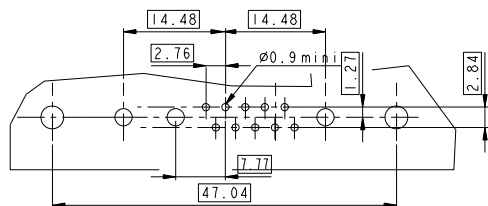

# 21W1

## LAYOUT AND CONNECTOR DIMENSIONS

For PCB hole diameters see table 1 sheet 1

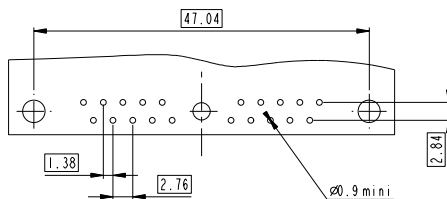

# 17W2

## LAYOUT AND CONNECTOR DIMENSIONS

For PCB hole diameters see table 1 sheet 1

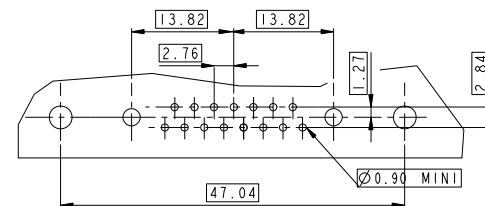

A

B

C

D

E

F

A

B

C

D

E

F

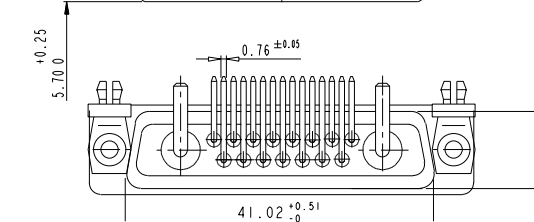
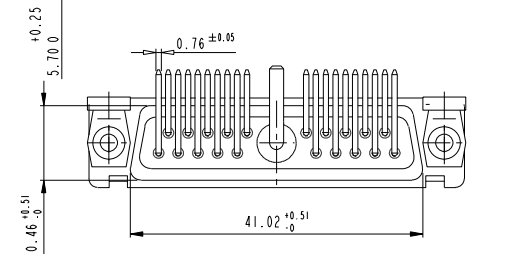
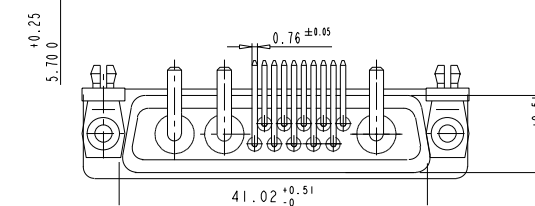
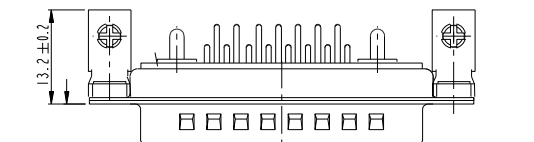
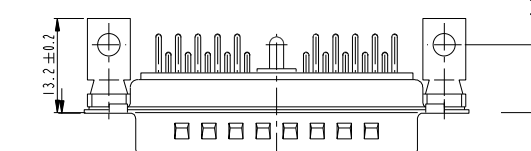
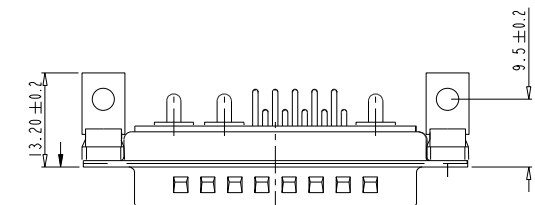
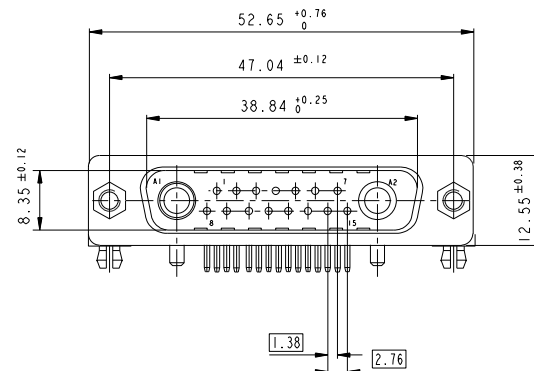
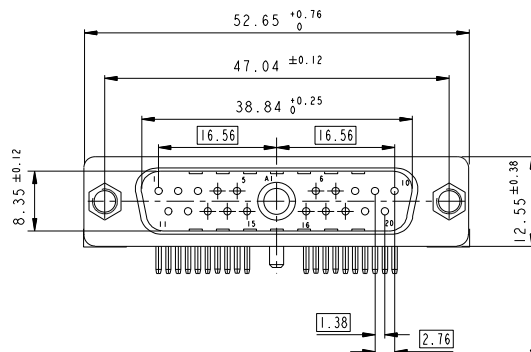
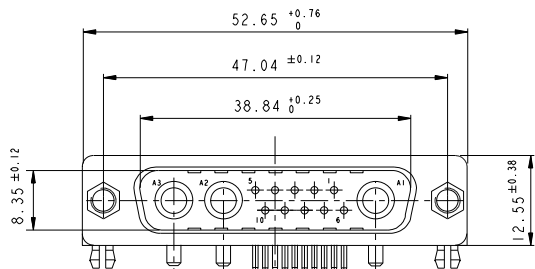

Copyright FCI. FCI

www.fciconnect.com		surface ISO 1302	tolerance std ISO 406 ISO 1101	projection mm
		TOLERANCES UNLESS OTHERWISE SPECIFIED		
Dr	M PESSON	2005-10-11	ANGULAR	size A2
Eng	P LEGARE	2005-10-11	LINEAR	Scale 2:1
Chr			0° ±2°	ECN F09-0092
Appr			Product family	Spec ref

FCI	TITLE SUB MALE DW US foot print mixed power right angled solder	eng no C01-8639-2305	Rev. D
-----	---	----------------------	--------

# 21WA4

LAYOUT AND CONNECTOR DIMENSIONS  
For PCB hole diameters see table I sheet 1

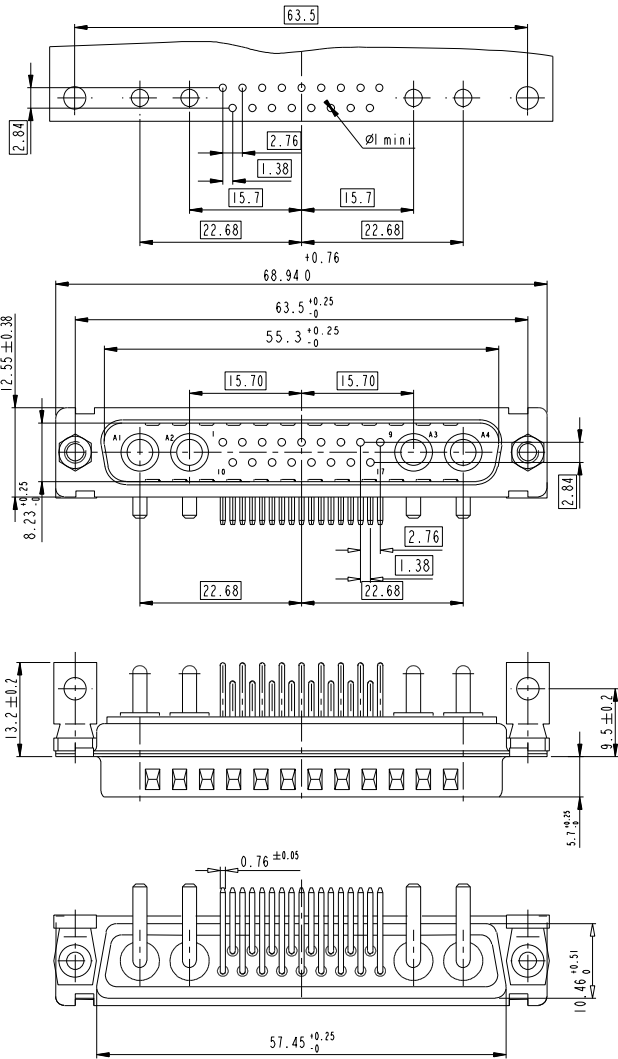

# 25W3

LAYOUT AND CONNECTOR DIMENSIONS  
For PCB hole diameters see table I sheet 1

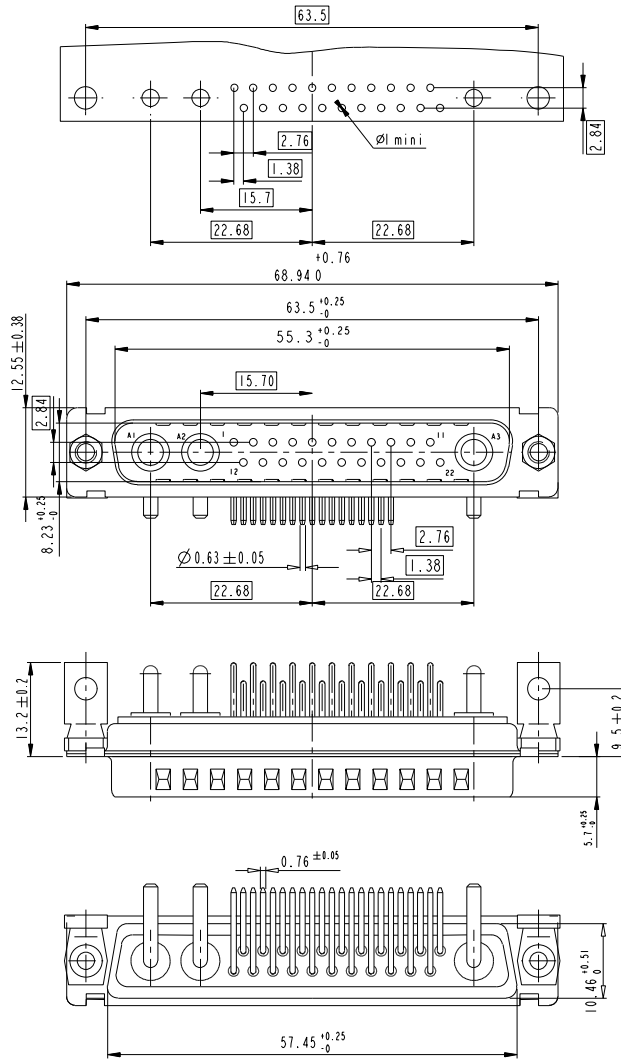

# 27W2

LAYOUT AND CONNECTOR DIMENSIONS  
For PCB hole diameters see table I sheet 1

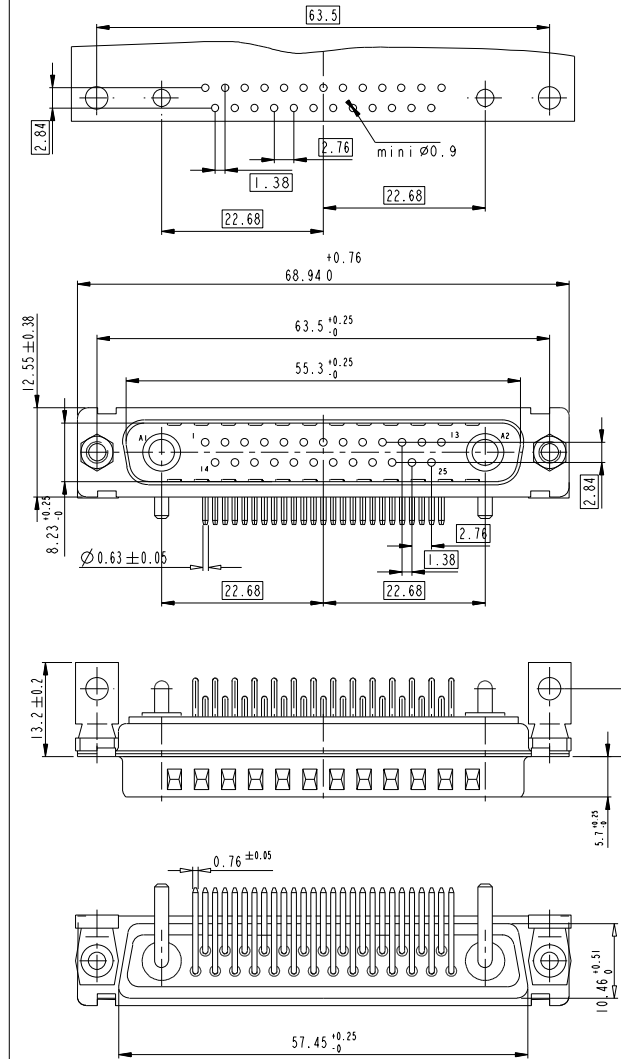

www.fciconnect.com		surface ISO 1302	tolerance std ISO 406 ISO 1101	projection mm
TOLERANCES UNLESS OTHERWISE SPECIFIED				
Dr	M PESSON	2005-10-11	ANGULAR	size A2
Eng	P LEGARE	2005-10-11	LINEAR	Scale 2:1
Chr			0° ±2°	ECN F09-0092
Appr			Product family	Spec ref

FCI	TITLE SUB MALE DW US foot print mixed power right angled solder	eng no C01-8639-2305	Rev. D
-----	---	-------------------------	-----------

# Mouser Electronics

Authorized Distributor

Click to View Pricing, Inventory, Delivery & Lifecycle Information:

[FCI / Amphenol:](#)

[DAO7W2P700M00LF](#) [DAO3W3P700G30LF](#)