

THIS DOCUMENT IS SUBJECT TO CHANGE WITHOUT NOTICE. IT IS CONFIDENTIAL AND A PROPERTY OF AMPHENOL LTW. DISCLOSURE TO THIRD PARTY HAS TO BE AUTHORIZED BY AMPHENOL LTW.

REV.	ECN NO.	DATE	SIGN	DESCRIPTION
B	LEN1450026	2014-04-29	Tom_gu	Change D Cut

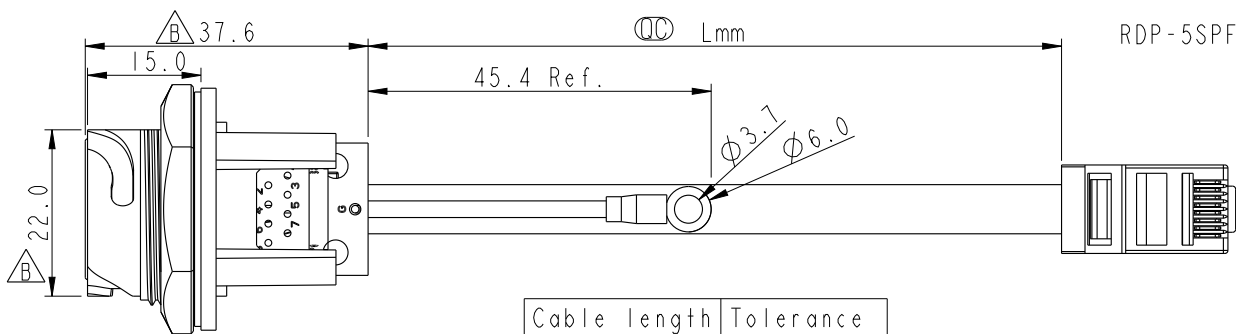
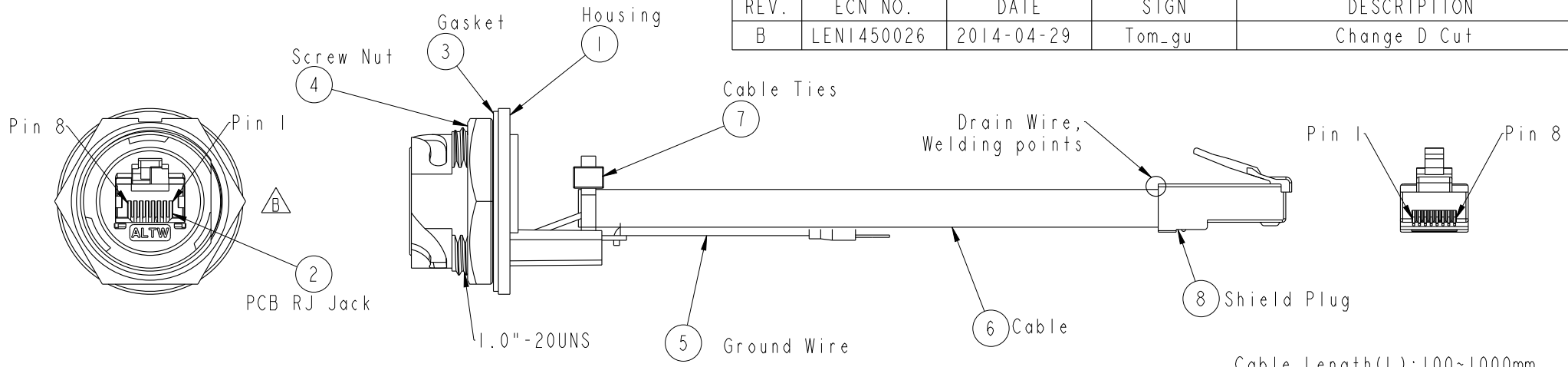

Cable Length(L): 100~1000mm
RDP-5SPFFG-TCM7BXX

XX:	100~1000mm
10:	100mm
15:	150mm
20:	200mm
95:	950mm
A0:	1000mm

Cable length	Tolerance
0.0~100 mm	±10 mm
101~300 mm	±15 mm
301~1000 mm	±20 mm

- Note:
- * \varnothing Important Dimension
 - * Waterproof Rate : IP67, MATED WATERPROOF
 - * Housing : Nylon+GF, BLACK
 - * Screw Nut : Nylon+GF, BLACK
 - * Gasket : Silicone, UL 94V-0, Gray.
 - * PCB: FR-4
 - * Cable: CAT5E FTP 24#*4P+D+AL/MY, 6.5
 - * Ground Terminal: Brass, Tin Plated, Thickness: 0.4mm
 - * Jack : PBT Polyester UL 94V-0
 - * Panel Thickness Max: 3.0mm
 - * Screw torsion value range: 8~15kgf-cm

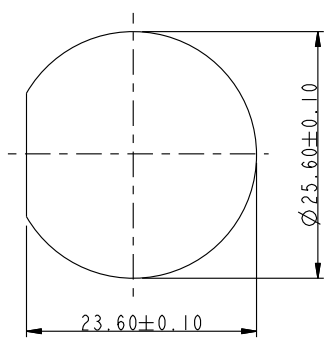

Ground	Wire (20AWG)	Green	Terminal
Shield	Drain Wire	接地線	Shield
8	Brown	棕	8
7	White/Brown	白/棕	7
6	Green	綠	6
5	White/Blue	白/藍	5
4	Blue	藍	4
3	White/Green	白/綠	3
2	Orange	橘	2
1	White/Orange	白/橘	1
Jack	Wire Color		Plug
	Pin Out		



UNIT : mm

TOLERANCE	
.X	±0.25
.XX	±0.1
.XXX	±0.05
ANGLES	±1°

TITLE: RJ45, D SIZE, MATED WATERPROOF ADD GROUND WIRE

SCALE	1:1	SIZE	A4	SHEET	1	OF	1
REV.	B	WC-REV.	A.7	\varnothing : Inspection item			

Amphenol LTW
安費諾亮泰企業股份有限公司

ITEM NO	DRAWN BY	DATE
	Tom_gu	2014-04-29
DWG NO	CHECKED BY	DATE
RDP-5SPFFG-TCM7BXX	Tony	2014-04-29
CUSTOMER	APPROVED BY	DATE
ALTW	Victor	2014-04-29

Mouser Electronics

Authorized Distributor

Click to View Pricing, Inventory, Delivery & Lifecycle Information:

[Amphenol:](#)

[RDP-5SPFFG-TCM7B10](#)