

THIS DOCUMENT IS SUBJECT TO CHANGE WITHOUT NOTICE. IT IS CONFIDENTIAL AND A PROPERTY OF Amphenol LTW. DISCLOSURE TO THIRD PARTY HAS TO BE AUTHORIZED BY Amphenol LTW.

REV.	ECN NO.	DATE	SIGN	DESCRIPTION

ALTW
 DCC. DEPT.
 CONFIDENTIAL
 2012-04-03
ISSUED

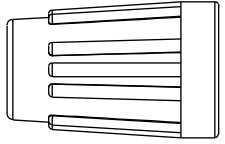

⑤ Sealing Nut

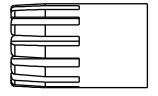

④ Clamp Ring

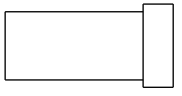

③ Seals B2

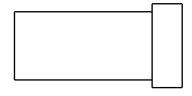

② Seals B1

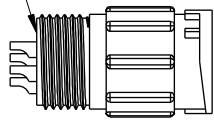

① Connector

With Liquid Glue
點 防水膠

ALTW
 CONFIDENTIAL
 2012-03-26
 R&D DEPT.

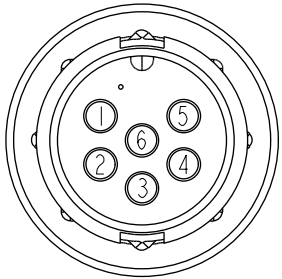
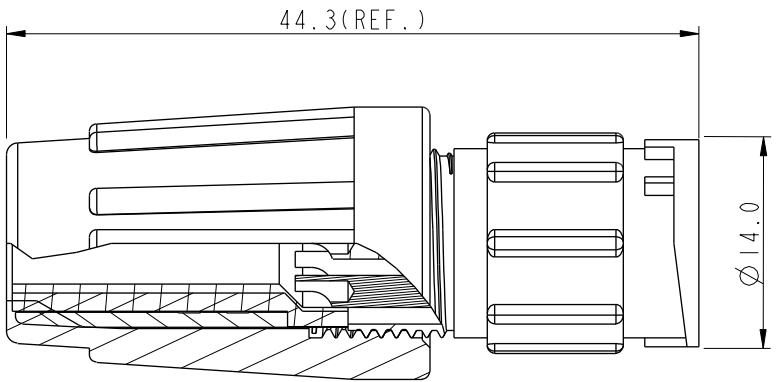

Pin Assignments
Front View 前視圖

Note:

- * Seals B1 for Cable OD: $\varnothing 4.5\text{mm} \sim \varnothing 6.5\text{mm}$
(防水墊圈B1線徑: $\varnothing 4.5\text{mm} \sim \varnothing 6.5\text{mm}$)
- * Seals B2 for Cable OD: $\varnothing 3.5\text{mm} \sim \varnothing 5.3\text{mm}$
(防水墊圈B2線徑: $\varnothing 3.5\text{mm} \sim \varnothing 5.3\text{mm}$)
- * One Set Unassembled in One PE Bag
(每一組未組裝, 放置於一個PE袋, 並封口)
- * CC Important Dimension.
- * Waterproof Rate: IP66
- * Housing: Black, Nylon+GF
- * Pin: Copper Alloy, Gold Plated
- * Seals: Black, EPDM
- * Clamping Ring: Black, Nylon
- * Sealing Nut: Black, Nylon
- * PE Bag: 90mm*85mm
- * Liquid Glue: Clear

UNIT: mm		
TOLERANCE	.X ± 0.25	
	.XX ± 0.1	
	.XXX ± 0.05	
ANGLES	$\pm 1^\circ$	

TITLE Standard, Assy Lock 6Pin M Conn M Pin			
SCALE 1:1	SIZE A4	SHEET 1 OF 1	
REV. A	WC-REV. A.2	CC : Inspection item	

Amphenol LTW
 安費諾亮泰企業股份有限公司

ITEM NO. BD-06BMMA-LL6001	DRAWN BY SamChang	DATE 2012-03-26
DWG NO. BD-06BMMA-LL6001	CHECKED BY Jeffrey	DATE 2012-04-03
CUSTOMER ALTW	APPROVED BY Lion	DATE 2012-04-03

Mouser Electronics

Authorized Distributor

Click to View Pricing, Inventory, Delivery & Lifecycle Information:

[Amphenol:](#)

[BD-06BMMA-LL6001](#)