

RECOMMENDED SCREW: 4-20 [M3.12 x 1.27]
 THREAD-FORMING SCREW,
 TORQUE: 6-10 IN-LB [0.68-1.13 NM]

REVISIONS					
REV	ECO	DESCRIPTION	DATE	BY	APPR
A1	-	RELEASE NEW DRAWING	15JUN18	SULLEN	TOMMY
A2	-	REVISED DRAWING	10JUL20	JHEAD	DH

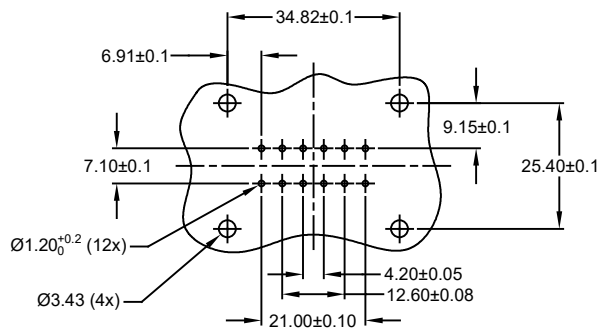
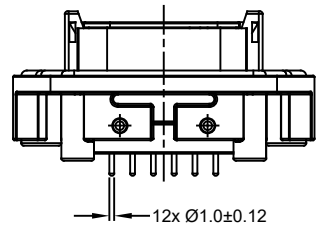
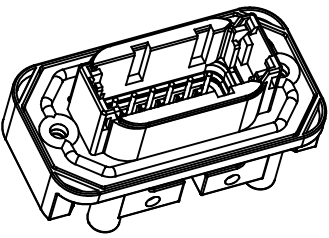
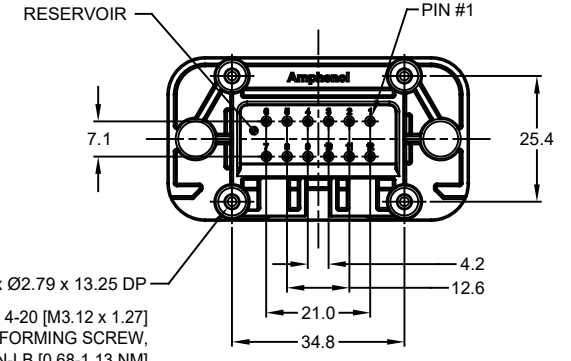

RECOMMENDED PCB LAYOUT
 VIEW FROM COMPONENTS
 SIDE OF PCB

NOTES: UNLESS OTHERWISE SPECIFIED

- MATERIAL:
 HOUSING: THERMOPLASTIC, GREY
 SEAL: SILICONE RUBBER
 CONTACT: COPPER ALLOY
- CONTACT PLATING: SEE SHEET 2
- MODIFICATIONS: FLANGE; STRAIGHT PCB MOUNT
- SPECIFICATIONS:
 4.1 CURRENT RATING: 7.5 AMPS
 4.2 OPERATING TEMPERATURE: -55°C TO +125°C
 4.3 DIELECTRIC WITHSTANDING VOLTAGE: LESS THAN 2 MILLIAMPS CURRENT LEAKAGE @ 1500 VOLTS AC
 4.4 INSULATION RESISTANCE: 1000 MEGOHMS MIN @ 25°C
 4.5 MOISTURE RESISTANCE: IP67 (MATED CONDITION)
 4.6 MATING CYCLE DURABILITY: 100 CYCLES
 4.7 RoHS COMPLIANT

5. MATING PART: ATM06-12SX*
 (X = A,B,C,D KEYS ; * = MODIFICATIONS AND COLORS)

\triangle 6. SEE SHEET 2 FOR OTHER KEY ARRANGEMENTS AND COLORS

7. ALL DIMENSIONS ARE FOR REFERENCE USE ONLY

8. POTTED CONNECTORS SPECIFIED FOR UP TO 5 P.S.I. APPLICATIONS.

TITLE: PCB MOUNT RECEPTACLE, 12PIN, STRAIGHT FLANGE, ATM SERIES
 DWG NO.: ATM15-12PX-BMXX
 REV: A2
 SH: 1
 OF: 2

QUANTITY	PART NUMBER	DESCRIPTION	ITEM
	ATM15-12PX-BMXX	DTM15-12PA, DTM15-12PB, DTM15-12PC, DTM15-12PD, DTM15-12PA-G003, DTM15-12PB-G003, DTM15-12PC-G003	
MATERIALS LIST			
UNLESS OTHERWISE SPECIFIED 1) All dimensions are in metric(mm) 2) Tolerances are as follows: 1 PL DEC ±0.30 Fractions ±1/64 2 PL DEC ±0.15 Angles ±1° 3 PL DEC ±0.08 3) Note reference = \triangle		SIGNATURES DATE DRAWN: SULLEN,ZHANG 15JUN18 CHECKED: ORION,LI 15JUN18 ENGINEER: APPROVAL: TOMMY,XIE 15JUN18	
MATERIAL SPECIFICATIONS:		CUSTOMER:	
PROCESS SPECIFICATIONS:		THIS DRAWING IS SUPPLIED FOR INFORMATION ONLY. DESIGN FEATURES, SPECIFICATIONS AND PERFORMANCE DATA SHOWN HEREON ARE THE PROPERTY OF THE AMPHENOL CORPORATION. NO RIGHTS OF REPRODUCTION ARE IMPLIED. ALL DIMENSIONS ARE SUBJECT TO NORMAL MANUFACTURING VARIATIONS.	
NEXT ASSY:		SIZE: B C- SCALE: NONE	DWG NO.: ATM15-12PX-BMXX REVISION: A2 SHEET 1 OF 2

Amphenol
 Sine Systems - www.amphenol-sine.com
 44724 Morley Drive
 Clinton Township, MI 48036

BOARDLOCK PCB MOUNT RECEPTACLE,
 12 PIN, STRAIGHT FLANGE, ATM SERIES

REVISIONS					
REV	ECO	DESCRIPTION	DATE	BY	APPR
A1	-	RELEASE NEW DRAWING	15JUN18	SULLEN	TOMMY
A2	-	REVISED DRAWING	10JUL20	JHEAD	DH

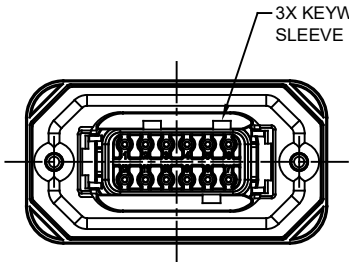

ATM15-12PA-BMXX
KEY A

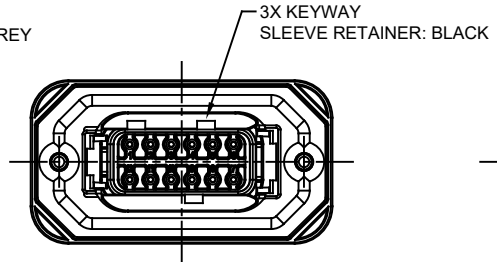

ATM15-12PB-BMXX
KEY B

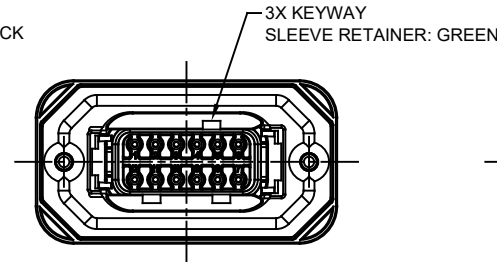

ATM15-12PC-BMXX
KEY C

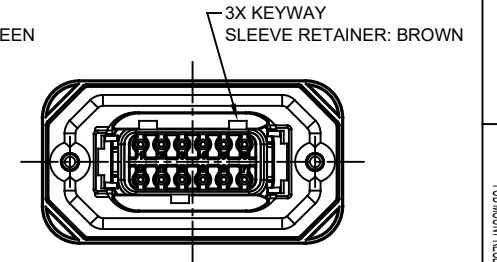

ATM15-12PD-BMXX
KEY D

ATM15-12PA-BMXX VARIANTS		
CONTACT PLATING	POTTING OR NOT IN RESERVOIR	PART NUMBER
GOLD	NO POTTING	ATM15-12PA-BM01
GOLD	POTTING	ATM15-12PA-BM02
TIN	NO POTTING	ATM15-12PA-BM03
TIN	POTTING	ATM15-12PA-BM04

ATM15-12PB-BMXX VARIANTS		
CONTACT PLATING	POTTING OR NOT IN RESERVOIR	PART NUMBER
GOLD	NO POTTING	ATM15-12PB-BM01
GOLD	POTTING	ATM15-12PB-BM02
TIN	NO POTTING	ATM15-12PB-BM03
TIN	POTTING	ATM15-12PB-BM04

ATM15-12PC-BMXX VARIANTS		
CONTACT PLATING	POTTING OR NOT IN RESERVOIR	PART NUMBER
GOLD	NO POTTING	ATM15-12PC-BM01
GOLD	POTTING	ATM15-12PC-BM02
TIN	NO POTTING	ATM15-12PC-BM03
TIN	POTTING	ATM15-12PC-BM04

ATM15-12PD-BMXX VARIANTS		
CONTACT PLATING	POTTING OR NOT IN RESERVOIR	PART NUMBER
GOLD	NO POTTING	ATM15-12PD-BM01
GOLD	POTTING	ATM15-12PD-BM02
TIN	NO POTTING	ATM15-12PD-BM03
TIN	POTTING	ATM15-12PD-BM04

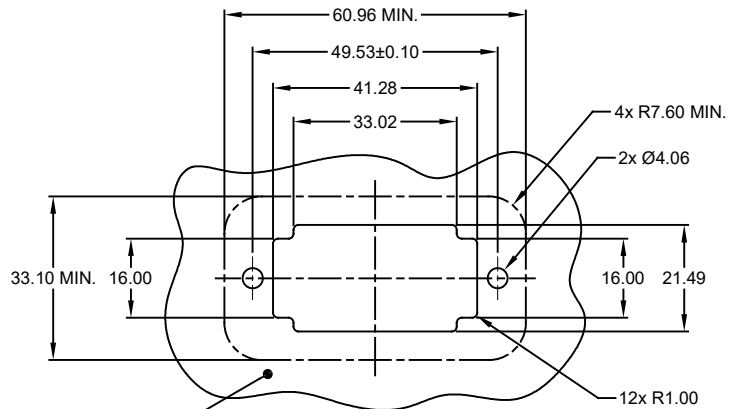

INTERNAL SEALING SURFACE
FINISH TO BE ≥ 2 OR BETTER $\sqrt{0.13}$

RECOMMENDED PANEL
CUTOUT

ATM15-12PX-BMXX		DESCRIPTION		ITEM
PART NUMBER		DESCRIPTION		ITEM
QUANTITY				
MATERIALS LIST				
UNLESS OTHERWISE SPECIFIED:		SIGNATURES		DATE
1) All dimensions are in metric(mm).		DRAWN: SULLEN,ZHANG		15JUN18
2) Tolerances are as follows:		CHECKED: ORION,LI		15JUN18
1 PL DEC ±0.35 Fractions ±1/64		ENGINEER:		
2 PL DEC ±0.15 Angles ±1°		APPROVAL: TOMMY,XIE		15JUN18
3 PL DEC ±0.08		MATERIAL SPECIFICATIONS:		
3) Note reference = Δ		CUSTOMER:		
PROCESS SPECIFICATIONS:		THIS DRAWING IS SUPPLIED FOR INFORMATION ONLY. DESIGN FEATURES, SPECIFICATIONS AND PERFORMANCE DATA SHOWN HEREON ARE THE PROPERTY OF THE AMPHENOL CORPORATION. NO RIGHTS OF REPRODUCTION ARE IMPLIED. ALL DIMENSIONS ARE SUBJECT TO NORMAL MANUFACTURING VARIATIONS.		
NEXT ASSY:		SCALE: NONE		
		SIZE: B C-		TYPE: ATM15-12PX-BMXX
		DWG NO: ATM15-12PX-BMXX		REVISION: A2
		SHEET 2 OF 2		

TITLE: PCB MOUNT RECEPTACLE, 12PIN, STRAIGHT FLANGE, ATM SERIES
DWG NO: ATM15-12PX-BMXX
REV: A2
SH: 2
OF: 2

Mouser Electronics

Authorized Distributor

Click to View Pricing, Inventory, Delivery & Lifecycle Information:

[Amphenol:](#)

[ATM15-12PB-BM04](#)