

This document is the property of Amphenol Corporation and is delivered on the express condition that it is not to be disclosed, reproduced or used, in whole or in part, for manufacture or sale by anyone other than Amphenol Corporation without its prior consent, & that no right is granted to disclose or to use any information in this document.

Customer Drawing

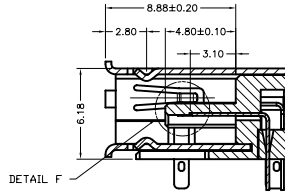

REVISIONS				
SYM	ECN	DESCRIPTION	DATE	APPROVED
1.1	HKXXXX	Initially release	01/30/08	IP
1.2	HKXXXX	Changed Dimension	03/05/08	IP
1.3	HKXXXX	Update Drawing	03/23/08	IP
1.4	HKXXXX	Add the dimension	04/03/08	IP

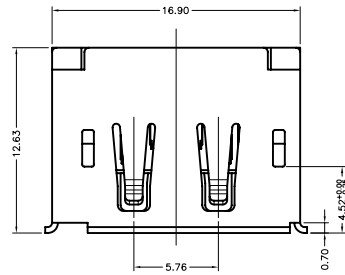

SECTION A-A

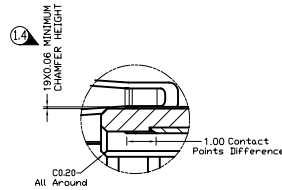
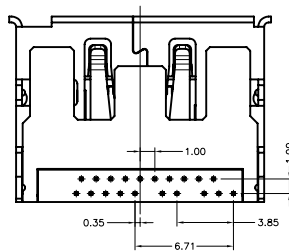
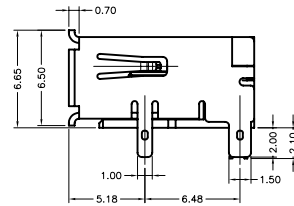
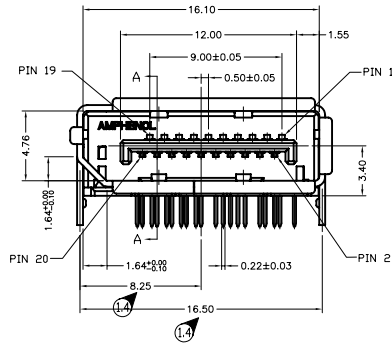

DETAIL E SCALE 2:1

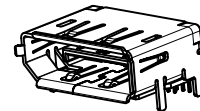

NOTES:

- MATERIAL:
 - HOUSING: HIGH TEMPERATURE PLASTIC UL94V-0, BLACK.
 - CONTACT: PHOSPHOR BRONZE ,THICKNESS=0.20mm
 - SHIELD: BRASS OR SPCC, THICKNESS=0.4mm
- FINISH:
 - CONTACT: REFER TO P/N SYSTEM ON MATING AREA
 - 1.27~2.54um NICKEL UNDERPLATE OVERALL
 - 2.54~5.08um PURE TIN ON SOLDER TAIL
 - SHIELD: REFER TO P/N SYSTEM
- ELECTRICAL SPECIFICATION:
 - CURRENT RATING: 0.5A
 - CONTACT RESISTANCE: 30mΩ MAX
 - INSULATOR RESISTANCE: 100MΩ MIN(UNMATED) 10MΩ MIN(MATED)
 - DIELECTRIC WITHSTANDING VOLTAGE: 500 V AC(UNMATED) 300 V AC(MATED)
- ORDER P/N SYSTEM: DP-F202-002-X-X-XX
 - MATING AREA PLATING:
 - 1- 0.76um MIN Au.
 - 2- 0.38um MIN Au.
 - A- Gold FLASH
 - PACKING METHOD:
 - N/A- PACKING IN TRAY.
 - TR- PACKING IN TAPE AND REEL.
 - SHELL PLATING:
 - 1- GOLD FLASH PLATED.
 - 2- SOLDERABLE NICKEL PLATED.
 - 3- TIN PLATED.

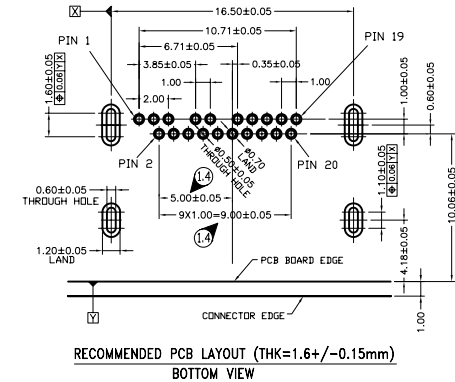

ITEM	PART NO.	REQ'D	DESCRIPTION
PARTS LIST			
UNLESS OTHERWISE SPECIFIED TOLERANCES		APPROVAL DATE	
U.S. METRIC		DRAWN Drack.Xie 04/01/08	
.X +/- ±0.50		CHECKED Ran.Xiao 04/01/08	
.XX +/- ±0.25		CHECKED	
.XXX +/- ±0.10		DRAWING FILE :	
FRACTIONS +/-		Drawing/DP/CDP-F202-002-X-X-XX	
ANGLES +/-		TITLE	
REMOVE SHARP EDGES		DISPLAYPORT R/A T/H RECEPTACLE (SHELL DIP)	
DIMENSIONS		ANGLE OF PROJECTION	
U.S. INCHES		SIZE DRAWING NO.	
(METRIC) (MM)		A3 C DP-F202-002-X-X-XX REV. 1.4	
		SCALE NONE SHEET 1 OF 1	

Mouser Electronics

Authorized Distributor

Click to View Pricing, Inventory, Delivery & Lifecycle Information:

[Amphenol:](#)

[DPF20200212](#)