

THIS DOCUMENT IS SUBJECT TO CHANGE WITHOUT NOTICE. IT IS CONFIDENTIAL AND A PROPERTY OF Amphenol LTW. DISCLOSURE TO THIRD PARTY HAS TO BE AUTHORIZED BY Amphenol LTW.

REV.	ECN NO.	DATE	SIGN	DESCRIPTION
B	LEN1741194~97	2017/04/11	Jinhai	Add The Size Table
C	C200275	2020/03/12	Nan_Su	$\triangle C$ X1
D	C210309	2021/02/24	Ruru	$\triangle D$ X4

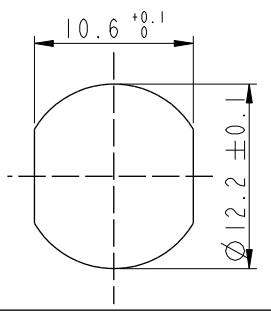

Recommended Panel Cut-Out

$\triangle D$   
M12A-XXPMMR-SF7003  
XX: No. Of Pin

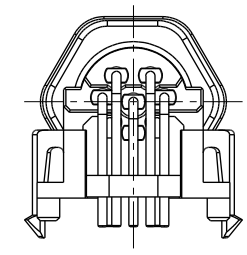
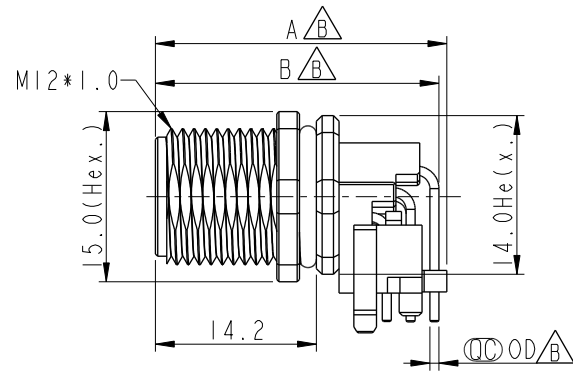
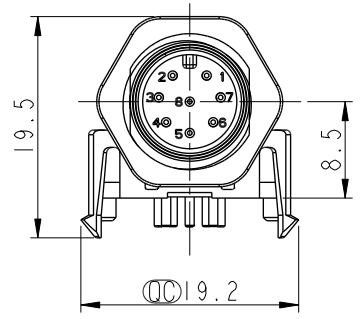
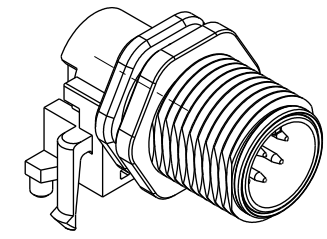
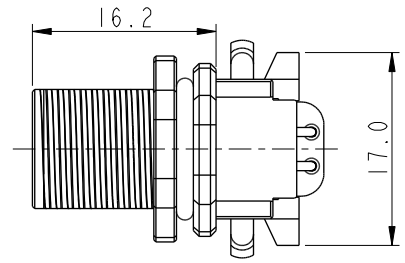

M12A-03PMMR-SF7003	25.9	24.8	1.0	$\triangle B$
M12A-04PMMR-SF7003	25.9	24.8	1.0	
M12A-05PMMR-SF7003	25.9	24.8	1.0	
M12A-08PMMR-SF7003	25.7	25.0	0.8	
Item No.	A	B	OD	

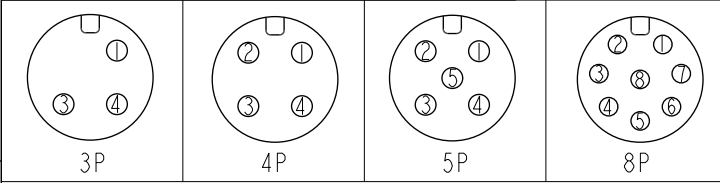

Pin Assignment Front View

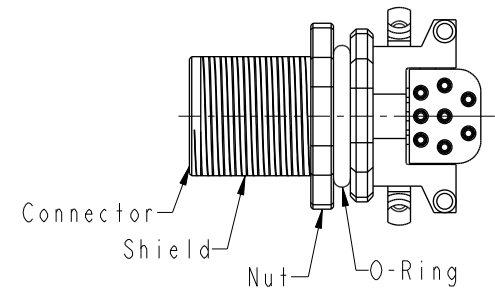

- $\triangle D$  Note:
- \* RoHS Compliant
  - \*  $\odot$  Important dimension
  - \* Waterproof rate: IPX7, mated
  - \* Connector
  - Housing: Thermoplastic, Black
  - Pin: Copper alloy, Gold plated
  - O-Ring: Rubber, Black
  - \* Shield: Metal
  - \* Nut: Metal
  - \* O-Ring: Rubber, Gray
  - \* For panel thickness max: 3.0mm
  - $\triangle C$  \* For pcb thickness max: 1.6mm
  - \* O-Ring and nut are assembled on connectors

UNIT: mm		TITLE	
TOLERANCE	$\pm 0.25$	N SEN, M12 A, SCREW RECEPTACLE, M, M, PCB R $\triangle D$	
.X	$\pm 0.1$	SCALE	3:2
.XX	$\pm 0.05$	SIZE	A4
.XXX	$\pm 0.05$	SHEET	1 OF 2
ANGLES	$\pm 1^\circ$	REV.	D
		WC-REV.	A.3
		$\odot$	Inspection item

**Amphenol LTW**  
安費諾亮泰企業股份有限公司

ITEM NO.	DRAWN BY	DATE
	Jinhai	2017-04-11
DWG NO.	CHECKED BY	DATE
M12A-XXPMMR-SF7003	Feng-li	2017-04-11
CUSTOMER	APPROVED BY	DATE
ALTW	Jerry	2017-04-11

THIS DOCUMENT IS SUBJECT TO CHANGE WITHOUT NOTICE. IT IS CONFIDENTIAL AND A PROPERTY OF Amphenol LTW. DISCLOSURE TO THIRD PARTY HAS TO BE AUTHORIZED BY Amphenol LTW.

PCB Layout

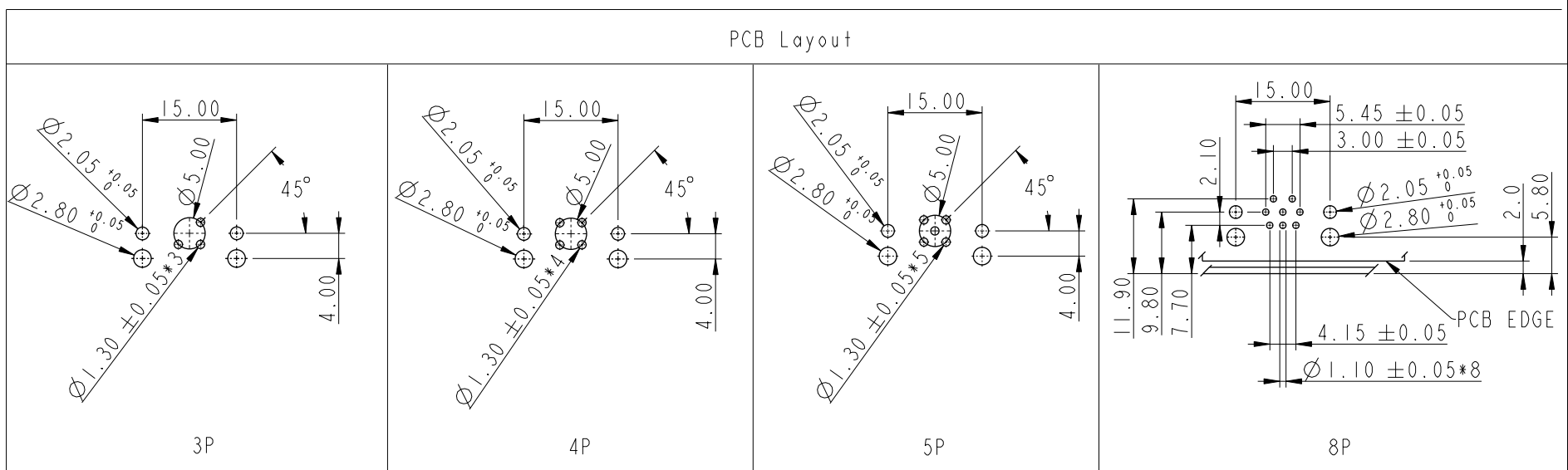

3P

4P

5P

8P

UNIT: mm

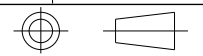

TITLE  
N SEN, M12 A, SCREW  
RECEPTACLE, M, M, PCB R  $\triangle$

**Amphenol LTW**

ITEM NO

DRAWN BY  
Yulong\_wang

DATE  
2017-04-11

DWG NO  
M12A-XXPMMR-SF7003

CHECKED BY  
Jinhai

DATE  
2017-04-11

CUSTOMER  
ALTW

APPROVED BY  
Jerry

DATE  
2017-04-11

TOLERANCE	
.X	±0.25
.XX	±0.1
.XXX	±0.05
ANGLES	±1°

SCALE	3:2	SIZE	A4	SHEET	2	OF	2
REV.	D	WC-REV.	A.3	☉: Inspection item			

安費諾亮泰企業股份有限公司

# Mouser Electronics

Authorized Distributor

Click to View Pricing, Inventory, Delivery & Lifecycle Information:

[Amphenol:](#)

[M12A-03PMMR-SF7003](#)