

PRODUCT NUMBER	PLATING PERFORMANCE LEVEL	APPLICATION	FOR REAR PLUG-UP APPLICATIONS USE SHROUD
74817-1ZZZ	TELCORDIA CO	STANDARD	84818-104
74817-1ZZZLF		LEAD FREE	84818-104LF
74817-5ZZZ	TELCORDIA UE	STANDARD	84818-504
74817-5ZZZLF		LEAD FREE	84818-504LF
74817-9ZZZ	TELCORDIA CO	STANDARD	84818-104
74817-9ZZZLF		LEAD FREE	84818-104LF

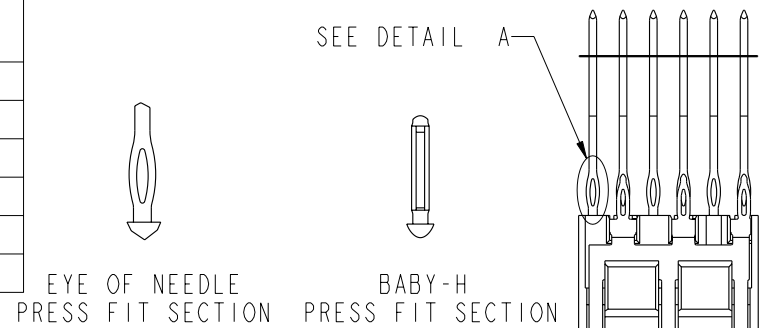

DETAIL A
SCALE 4:1
SEE NOTE 16

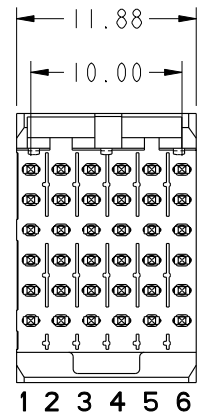
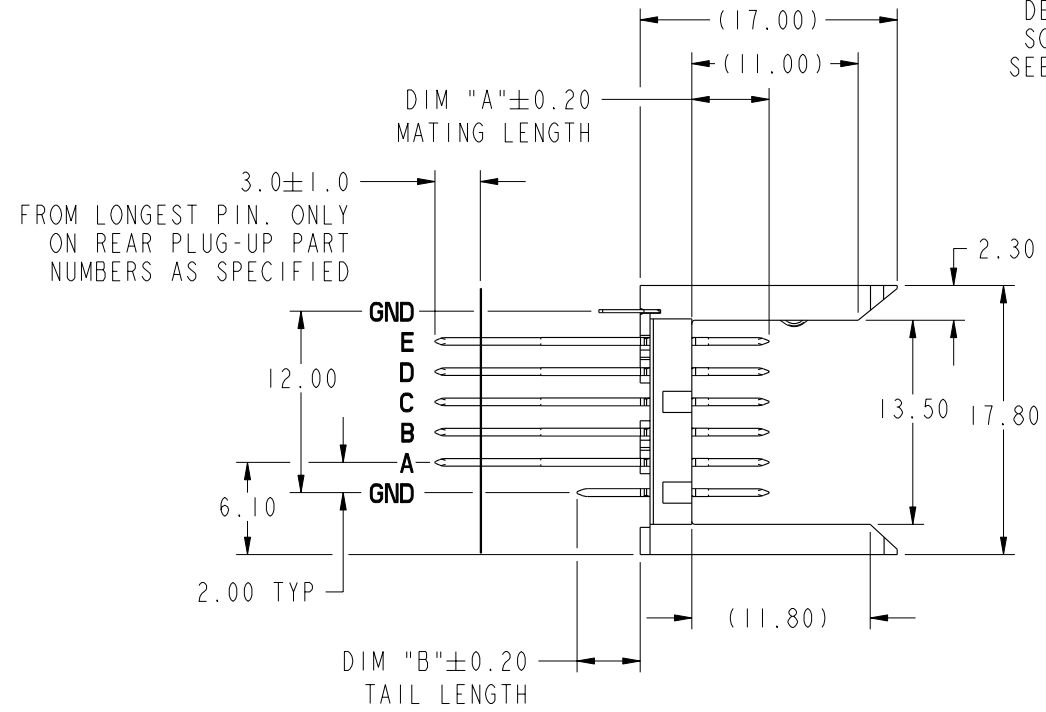

mat'l code SEE NOTE 5				tolerances unless otherwise specified				CUSTOMER		FCj www.fciconnect.com	
ltr	ecn no.	dr	date	0.X ± 0.3		COPY		title			
AW	V08-0141	LP	2008-03-28	0.XX ± 0.13		projection		VERTICAL SIGNAL HDR 5 ROW			
-	-	-	-	.XXX ± .051		MM		P.F. 30 POS. SELECT LOAD STD.			
AR	V07-0187	DCH	2007-04-24	0° ± 2°		MM		product family		code	
AS	V07-0676	HTB	2007-11-07	dr	K. BELL	2000-03-29	← MM →		METRAL 1000		213
AT	V07-0697	LP	2007-11-29	engr	M. HAHN	2000-03-29	scale		size		sheet
AU	V08-0002	HTB	2008-01-09	chr	M. HAHN	2000-03-29	2:1		dwg no		1 of 9
AV	V08-0048	LP	2008-2-1	appd	M. HAHN	2000-03-29	A		74817		
sheet index	revision sheet	AW	AW	AW	AW	AW	AW	AW	AW	AW	
		1	2	3	4	5	6	7	8	9	



This document is the property of and embodies CONFIDENTIAL and PROPRIETARY information of FCj. No part of the information shown on this document may be used in any way or disclosed to others without the written consent of FCj. Copyright FCj.

PRODUCT NUMBER
SEE SHEET 1

PRESS-FIT HOLES	OPTION 1
HOLE DIAMETER AFTER PLATING	0.65-0.80
DRILLED HOLE	0.81-0.86 (0.85 DRILL)
COPPER PLATING	0.025 MIN
SnPb PLATING	0.005-0.015

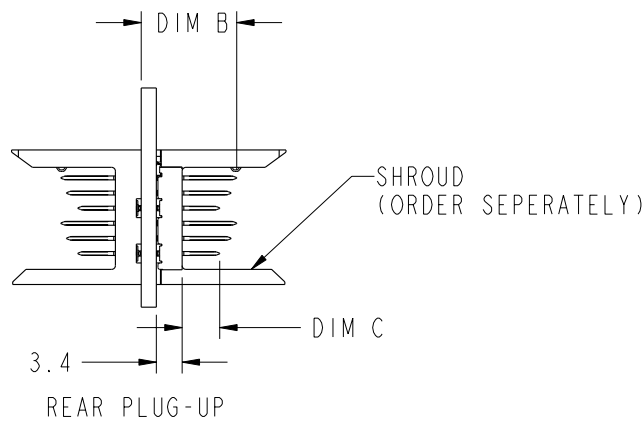

SEE PRINT 58351 FOR ADDITIONAL
PCB INFORMATION

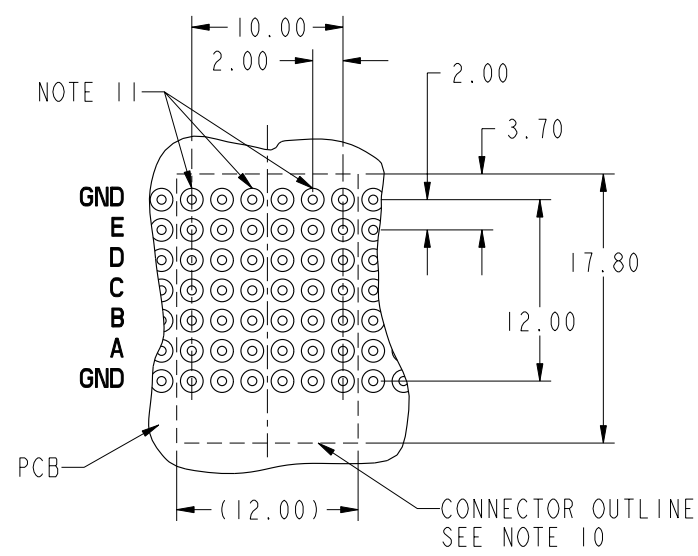

RECOMMENDED PCB HOLE PATTERN
(COMPONENT SIDE)

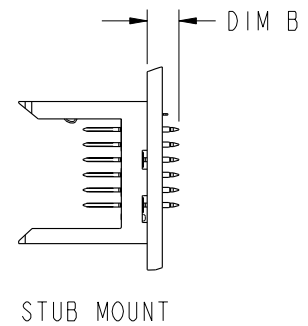

mat'l code SEE NOTE 5				tolerances unless otherwise specified		CUSTOMER		FCj www.fciconnect.com	
ltr	ecr no.	dr	date	linear	0.X ±0.3		COPY		title VERTICAL SIGNAL HDR 5 ROW P.F. 30 POS. SELECT LOAD STD.
AW					0.XX ±0.13		projection		
					.XXX ±.051				
				angles	0° ±2°				product family METRAL 1000 code size dwg no 213 sheet 2
					dr	K. BELL	2000-03-29	MM	
				enrg	M. HAHN	2000-03-29	← MM →		A 74817
				chr	M. HAHN	2000-03-29	scale		
				appd	M. HAHN	2000-03-29	2:1		
sheet index	revision sheet								cage code 22526

This document is the property of and embodies
 CONFIDENTIAL and PROPRIETARY information of FCj.
 No part of the information shown on this
 document may be used in any way or disclosed
 to others without the written consent of FCj.
 Copyright FCj.

PIN CODE NO.	DIM A MATING LENGTH	DIM B TAIL LENGTH	PCB THICKNESS RANGE ACCOMMODATED BY PIN'S TAIL LENGTH				
			WHEN MATING TO A 73981 OR 84688 SERIES METRAL 1000 RECEPTACLE		WHEN MATING TO A 52057 SERIES METRAL 4000 RECEPTACLE		
			ROWS A,B,C,D,E	GROUND ROW	ROWS:A,B,D,E	ROW C	GROUND ROW
01*	5.00	4.30	1.60 MIN	1.60 MIN	1.60 MIN	1.60 MIN	1.60 MIN
22		12.20	2.95 - 3.80	2.95 - 4.20	2.95 - 3.80	2.95 - 3.80	2.95 - 4.20
30		12.95	2.95 - 4.55	3.25 - 4.95	2.95 - 4.55	2.95 - 4.55	3.25 - 4.95
05		13.70	2.95 - 5.30	4.00 - 5.70	3.30 - 5.30	2.95 - 5.30	4.00 - 5.70
35		14.45	3.05 - 6.05	4.75 - 6.45	4.05 - 6.05	3.05 - 6.05	4.75 - 6.45
48		15.20	3.80 - 6.80	5.50 - 7.20	4.80 - 6.80	3.80 - 6.80	5.50 - 7.20
40		15.70	4.30 - 7.30	6.00 - 7.70	5.30 - 7.30	4.30 - 7.30	6.00 - 7.70
65		16.40	5.00 - 8.00	6.70 - 8.40	6.00 - 8.00	5.00 - 8.00	6.70 - 8.40
09		17.10	5.70 - 8.70	7.40 - 9.10	6.70 - 8.70	5.70 - 8.70	7.40 - 9.10
02*	5.75	4.30	1.60 MIN	1.60 MIN	1.60 MIN	1.60 MIN	1.60 MIN
44		12.20	2.95 - 3.80	2.95 - 4.20	2.95 - 3.80	2.95 - 3.80	2.95 - 4.20
31		12.95	2.95 - 4.55	3.25 - 4.95	2.95 - 4.55	2.95 - 4.55	3.25 - 4.95
06		13.70	2.95 - 5.30	4.00 - 5.70	3.30 - 5.30	2.95 - 5.30	4.00 - 5.70
36		14.45	3.05 - 6.05	4.75 - 6.45	4.05 - 6.05	3.05 - 6.05	4.75 - 6.45
49		15.20	3.80 - 6.80	5.50 - 7.20	4.80 - 6.80	3.80 - 6.80	5.50 - 7.20
25		15.70	4.30 - 7.30	6.00 - 7.70	5.30 - 7.30	4.30 - 7.30	6.00 - 7.70
66		16.40	5.00 - 8.00	6.70 - 8.40	6.00 - 8.00	5.00 - 8.00	6.70 - 8.40
10		17.10	5.70 - 8.70	7.40 - 9.10	6.70 - 8.70	5.70 - 8.70	7.40 - 9.10
03*	6.50	4.30	1.60 MIN	1.60 MIN	1.60 MIN	1.60 MIN	1.60 MIN
45		12.20	2.95 - 3.80	2.95 - 4.20	2.95 - 3.80	2.95 - 3.80	2.95 - 4.20
32		12.95	2.95 - 4.55	3.25 - 4.95	2.95 - 4.55	2.95 - 4.55	3.25 - 4.95
07		13.70	2.95 - 5.30	4.00 - 5.70	3.30 - 5.30	2.95 - 5.30	4.00 - 5.70
37		14.45	3.05 - 6.05	4.75 - 6.45	4.05 - 6.05	3.05 - 6.05	4.75 - 6.45
50		15.20	3.80 - 6.80	5.50 - 7.20	4.80 - 6.80	3.80 - 6.80	5.50 - 7.20
41		15.70	4.30 - 7.30	6.00 - 7.70	5.30 - 7.30	4.30 - 7.30	6.00 - 7.70
24		16.40	5.00 - 8.00	6.70 - 8.40	6.00 - 8.00	5.00 - 8.00	6.70 - 8.40
11		17.10	5.70 - 8.70	7.40 - 9.10	6.70 - 8.70	5.70 - 8.70	7.40 - 9.10



This document is the property of and embodies CONFIDENTIAL and PROPRIETARY information of FCI. No part of the information shown on this document may be used in any way or disclosed to others without the written consent of FCI. Copyright FCI.

* STUB PINS - NO REAR PLUG-UP
 ** THE GREATEST RANGE OCCURS WHEN THE B DIMENSION OF PIN 'GND' IS ONE SIZE SHORTER THEN THE OTHER PINS.

mat'l code		SEE NOTE 5		tolerances unless otherwise specified		CUSTOMER		www.fciconnect.com	
ltr	ecn no.	dr	date	linear	0.X ±0.3		COPY		title VERTICAL SIGNAL HDR 5 ROW P.F. 30 POS. SELECT LOAD STD.
AW					0.XX ±0.13		projection		
					.XXX ±.051				
				angles	0° ±2°				product family METRAL 1000 code size dwg no 213 sheet 3
					dr	K. BELL	2000-03-29	MM 	
				engr	M. HAHN	2000-03-29	scale 2:1 A 74817		
				chr	M. HAHN	2000-03-29			
				appd	M. HAHN	2000-03-29			
sheet index	revision sheet								

PIN CODE NO.	DIM A MATING LENGTH	DIM B TAIL LENGTH	PCB THICKNESS RANGE ACCOMMODATED BY PIN LENGTH				
			WHEN MATING TO A 73981 OR 84688 SERIES RECEPTACLE		WHEN MATING TO A 52057 SERIES METRAL 4000 RECEPTACLE		
			ROWS A,B,C,D,E	GROUND ROW	ROWS:A,B,D,E	ROW C	GROUND ROW
04*	7.25	4.30	1.60 MIN	1.60 MIN	1.60 MIN	1.60 MIN	1.60 MIN
46		12.20	2.95 - 3.80	2.95 - 4.20	2.95 - 3.80	2.95 - 3.80	2.95 - 4.20
33		12.95	2.95 - 4.55	3.25 - 4.95	2.95 - 4.55	2.95 - 4.55	3.25 - 4.95
08		13.70	2.95 - 5.30	4.00 - 5.70	3.30 - 5.30	2.95 - 5.30	4.00 - 5.70
38		14.45	3.05 - 6.05	4.75 - 6.45	4.05 - 6.05	3.05 - 6.05	4.75 - 6.45
51		15.20	3.80 - 6.80	5.50 - 7.20	4.80 - 6.80	3.80 - 6.80	5.50 - 7.20
42		15.70	4.30 - 7.30	6.00 - 7.70	5.30 - 7.30	4.30 - 7.30	6.00 - 7.70
67		16.40	5.00 - 8.00	6.70 - 8.40	6.00 - 8.00	5.00 - 8.00	6.70 - 8.40
12		17.10	5.70 - 8.70	7.40 - 9.10	6.70 - 8.70	5.70 - 8.70	7.40 - 9.10
19*	8.00	4.30	1.60 MIN	1.60 MIN	1.60 MIN	1.60 MIN	1.60 MIN
47		12.20	2.95 - 3.80	2.95 - 4.20	2.95 - 3.80	2.95 - 3.80	2.95 - 4.20
34		12.95	2.95 - 4.55	3.25 - 4.95	2.95 - 4.55	2.95 - 4.55	3.25 - 4.95
20		13.70	2.95 - 5.30	4.00 - 5.70	3.30 - 5.30	2.95 - 5.30	4.00 - 5.70
39		14.45	3.05 - 6.05	4.75 - 6.45	4.05 - 6.05	3.05 - 6.05	4.75 - 6.45
52		15.20	3.80 - 6.80	5.50 - 7.20	4.80 - 6.80	3.80 - 6.80	5.50 - 7.20
43		15.70	4.30 - 7.30	6.00 - 7.70	5.30 - 7.30	4.30 - 7.30	6.00 - 7.70
68		16.40	5.00 - 8.00	6.70 - 8.40	6.00 - 8.00	5.00 - 8.00	6.70 - 8.40
21		17.10	5.70 - 8.70	7.40 - 9.10	6.70 - 8.70	5.70 - 8.70	7.40 - 9.10



This document is the property of and embodies CONFIDENTIAL and PROPRIETARY information of FCI. No part of the information shown on this document may be used in any way or disclosed to others without the written consent of FCI. Copyright FCI.

* STUB PINS - NO REAR PLUG-UP
 ** THE GREATEST RANGE OCCURS WHEN THE B DIMENSION OF PIN 'GND' IS ONE SIZE SHORTER THEN THE OTHER PINS.

mat'l code		SEE NOTE 5		tolerances unless otherwise specified		CUSTOMER		www.fciconnect.com	
ltr	ecr no.	dr	date	linear	0.X ±0.3		COPY		title VERTICAL SIGNAL HDR 5 ROW P.F. 30 POS. SELECT LOAD STD.
AW					0.XX ±0.13		projection		
					.XXX ±.051				
				angles	0° ±2°				product family METRAL 1000 code 213 size dwg no 74817 sheet 4
				dr	K. BELL	2000-03-29	scale 1:1		
				enrg	M. HAHN	2000-03-29	A		
				chr	M. HAHN	2000-03-29			cage code 22526
				appd	M. HAHN	2000-03-29			
sheet index	revision sheet								

METRAL P/N	ROW	CONTACT CODE					
		1	2	3	4	5	6
74817-X001 ** SEE NOTE 15 LEAD FREE OPTION	E	04	03	03	01	01	01
	D	04	03	03	01	01	01
	C	04	03	03	01	01	01
	B	04	03	03	01	01	01
	A	04	03	03	01	01	01
GND	01	01	01	01	01	01	

METRAL P/N	ROW	CONTACT CODE					
		1	2	3	4	5	6
74817-X006 ** SEE NOTE 15 LEAD FREE OPTION	E	19	03	03	03	02	01
	D	19	03	03	03	02	01
	C	19	03	03	03	02	01
	B	19	03	03	03	02	01
	A	19	03	03	03	02	01
GND	01	01	01	01	01	01	

METRAL P/N	ROW	CONTACT CODE						PCB THICKNESS RANGE FOR REAR PLUG UP APPL. : 2.30 (2.95) - 5.30 FOR METAL 1000 RECEPTACLE (NOT A STANDARD METRAL 1000 APPL.) AND 2.30 (3.30) - 5.30 FOR METRAL 4000 APPL.
		1	2	3	4	5	6	
74817-X011 *RPU SEE NOTE 15 LEAD FREE OPTION	E	05	05	05	05	05	05	
	D	05	05	05	05	05	05	
	C	05	05	05	05	05	05	
	B	05	05	05	05	05	05	
	A	05	05	05	05	05	05	
GND	01	01	01	01	01	01		

METRAL P/N	ROW	CONTACT CODE					
		1	2	3	4	5	6
74817-X002 ** SEE NOTE 15 LEAD FREE OPTION	E	01	01	01	01	03	04
	D	01	01	01	01	03	04
	C	01	01	01	01	03	04
	B	01	01	01	01	03	04
	A	01	01	01	01	03	04
GND	01	01	01	01	01	01	

METRAL P/N	ROW	CONTACT CODE						PCB THICKNESS RANGE FOR REAR PLUG UP APPLICATIONS: 2.30 (2.95) - 5.30 (NOT A STANDARD METRAL 1000 APPL.) CANNOT BE MATED TO A METRAL 4000 RECEPTACLE
		1	2	3	4	5	6	
74817-X007 *RPU ** SEE NOTE 15 LEAD FREE OPTION	E	20	07	07	07	06	05	
	D	20	07	07	07	06	05	
	C	20	07	07	07	06	05	
	B	20	07	07	07	06	05	
	A	20	07	07	07	06	05	
GND	01	01	01	01	01	01		

METRAL P/N	ROW	CONTACT CODE						PCB THICKNESS RANGE FOR REAR PLUG UP APPL. : 2.30 (2.95) - 5.30 FOR METAL 1000 RECEPTACLE (NOT A STANDARD METRAL 1000 APPL.) AND 2.30 (3.30) - 5.30 FOR METRAL 4000 APPL.
		1	2	3	4	5	6	
74817-X012 *RPU SEE NOTE 15 LEAD FREE OPTION	E	02	02	06	06	06	06	
	D	02	02	06	06	06	06	
	C	02	02	06	06	06	06	
	B	02	02	06	06	06	06	
	A	02	02	06	06	06	06	
GND	01	01	01	01	01	01		

METRAL P/N	ROW	CONTACT CODE					
		1	2	3	4	5	6
74817-X003 ** SEE NOTE 15 LEAD FREE OPTION	E	02	03	02	02	04	19
	D	02	03	02	02	04	19
	C	02	03	02	02	04	19
	B	02	03	02	02	04	19
	A	02	03	02	02	04	19
GND	01	01	01	01	01	01	

METRAL P/N	ROW	CONTACT CODE					
		1	2	3	4	5	6
74817-X008 ** SEE NOTE 15 LEAD FREE OPTION	E	19	03	03	03	03	03
	D	19	03	03	03	03	03
	C	19	03	03	03	03	03
	B	19	03	03	03	03	03
	A	19	03	03	03	03	03
GND	01	01	01	01	01	01	

METRAL P/N	ROW	CONTACT CODE						PCB THICKNESS RANGE FOR REAR PLUG UP APPL. : 2.30 (2.95) - 5.30 FOR METAL 1000 RECEPTACLE (NOT A STANDARD METRAL 1000 APPL.) AND 2.30 (3.30) - 5.30 FOR METRAL 4000 APPL.
		1	2	3	4	5	6	
74817-X013 *RPU SEE NOTE 15 LEAD FREE OPTION	E	06	06	06	06	02	02	
	D	06	06	06	06	02	02	
	C	06	06	06	06	02	02	
	B	06	06	06	06	02	02	
	A	06	06	06	06	02	02	
GND	01	01	01	01	01	01		

METRAL P/N	ROW	CONTACT CODE					
		1	2	3	4	5	6
74817-X004 ** SEE NOTE 15 LEAD FREE OPTION	E	03	02	02	04	19	02
	D	03	02	02	04	19	02
	C	03	02	02	04	19	02
	B	03	02	02	04	19	02
	A	03	02	02	04	19	02
GND	01	01	01	01	01	01	

METRAL P/N	ROW	CONTACT CODE						PCB THICKNESS RANGE FOR REAR PLUG UP APPLICATIONS: 2.30 (2.95) - 5.30 (NOT A STANDARD METRAL 1000 REAR PLUG UP APPL.) CANNOT BE MATED TO A METRAL 4000.
		1	2	3	4	5	6	
74817-X009 *RPU ** SEE NOTE 15 LEAD FREE OPTION	E	20	07	07	07	07	07	
	D	20	07	07	07	07	07	
	C	20	07	07	07	07	07	
	B	20	07	07	07	07	07	
	A	20	07	07	07	07	07	
GND	01	01	01	01	01	01		



METRAL P/N	ROW	CONTACT CODE						PCB THICKNESS RANGE FOR REAR PLUG UP APPL. : 5.70 - 8.70 FOR METRAL 1000 APPLIC. (NOT A STANDARD METRAL 1000 APPL.) AND 6.70 - 8.70 FOR A METRAL 4000 APPLICATION.
		1	2	3	4	5	6	
74817-X014 *RPU SEE NOTE 15 LEAD FREE OPTION	E	10	10	10	10	10	10	
	D	10	10	10	10	10	10	
	C	10	10	10	10	10	10	
	B	10	10	10	10	10	10	
	A	10	10	10	10	10	10	
GND	01	01	01	01	01	01		

METRAL P/N	ROW	CONTACT CODE						PCB THICKNESS RANGE FOR REAR PLUG UP APPLICATIONS: 3.25 - 4.55
		1	2	3	4	5	6	
74817-X005 *RPU SEE NOTE 15 LEAD FREE OPTION	E	06	06	06	06	06	06	
	D	06	06	06	06	06	06	
	C	06	06	06	06	06	06	
	B	06	06	06	06	06	06	
	A	06	06	06	06	06	06	
GND	30	30	30	30	30	30		

METRAL P/N	ROW	CONTACT CODE					
		1	2	3	4	5	6
74817-X010 SEE NOTE 15 LEAD FREE OPTION	E	03	03	03	03	03	03
	D	02	03	03	03	03	03
	C	03	03	03	03	03	03
	B	03	03	03	03	03	03
	A	03	03	03	03	03	03
GND	01	01	01	01	01	01	

METRAL P/N	ROW	CONTACT CODE					
		1	2	3	4	5	6
74817-X015 SEE NOTE 15 LEAD FREE OPTION	E	02	02	02	02	02	02
	D	02	02	02	02	02	02
	C	04	04	04	04	04	04
	B	02	02	02	02	02	02
	A	02	02	02	02	02	02
GND	02	02	02	02	02	02	

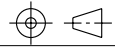
* REAR PLUG-UP PART NUMBER WITH PIN ALIGNER
 ** CANNOT BE MATED TO A METRAL 4000 RECEPTACLE
 *** REAR PLUG-UP PART NUMBER WITHOUT PIN ALIGNER

mat'l code SEE NOTE 5		tolerances unless otherwise specified		CUSTOMER	 www.fcjconnect.com
ltr	ecr no.	dr	date	COPY	
AW				projection	title VERTICAL SIGNAL HDR 5 ROW P.F. 30 POS. SELECT LOAD STD.
					
				angles	product family METRAL 1000 code size 213
				dr K. BELL 2000-03-29 engr M. HAHN 2000-03-29 chr M. HAHN 2000-03-29 appd M. HAHN 2000-03-29	
					product family METRAL 1000 code size 213 sheet 5
				scale 2:1	
sheet index	revision sheet				



This document is the property of and embodies
 CONFIDENTIAL and PROPRIETARY information of FCJ.
 No part of the information shown on this
 document may be used in any way or disclosed
 to others without the written consent of FCJ.
 Copyright FCJ.

METRAL P/N	ROW	CONTACT CODE					
		1	2	3	4	5	6
74817-X016 SEE NOTE 15 LEAD FREE OPTION	E	02	02	02	02	02	02
	D	02	02	02	02	02	02
	C	04	04	04	04	04	04
	B	01	02	02	02	02	01
	A	02	02	02	02	02	02
	GND	02	02	02	02	02	02

METRAL P/N	ROW	CONTACT CODE					
		1	2	3	4	5	6
74817-X024 *RPU SEE NOTE 15 LEAD FREE OPTION	E	05	05	05	05	05	05
	D	05	05	05	05	05	05
	C	05	05	05	05	05	05
	B	05	05	05	05	05	05
	A	05	05	05	05	05	05
	GND	01	01	01	01	01	01

PCB THICKNESS RANGE FOR REAR PLUG UP APPLI.: 2.30 (2.95) - 5.30 FOR METRAL 1000 APPLI. (NOT A STANDARD METRAL 1000 APPLI.) AND 2.30 (3.30) - 5.30 FOR METRAL 4000 RECEPTACLE APPLICATION

METRAL P/N	ROW	CONTACT CODE					
		1	2	3	4	5	6
74817-X029 SEE NOTE 15 LEAD FREE OPTION	E	01	01	01	01	01	01
	D	01	01	01	01	01	02
	C	01	01	01	01	01	01
	B	01	01	01	01	01	01
	A	01	01	03	01	01	03
	GND	01	01	01	01	01	01

METRAL P/N	ROW	CONTACT CODE					
		1	2	3	4	5	6
74817-X017 SEE NOTE 15 LEAD FREE OPTION	E	01	01	01	01	01	01
	D	01	01	01	01	01	01
	C	03	03	03	03	03	03
	B	01	01	01	01	01	01
	A	01	01	01	01	01	01
	GND	01	01	01	01	01	01

METRAL P/N	ROW	CONTACT CODE					
		1	2	3	4	5	6
74817-X025 ** SEE NOTE 15 LEAD FREE OPTION	E	01	19	01	01	01	01
	D	01	19	01	01	01	01
	C	01	19	01	01	01	01
	B	01	19	01	01	01	01
	A	01	19	01	01	01	01
	GND	01	01	01	01	01	01

METRAL P/N	ROW	CONTACT CODE					
		1	2	3	4	5	6
74817-X030 SEE NOTE 15 LEAD FREE OPTION	E	02	02	02	02	02	02
	D	02	02	02	02	02	02
	C	19	19	19	19	19	19
	B	02	02	02	02	02	02
	A	03	02	03	02	02	01
	GND	01	01	01	01	01	01

METRAL P/N	ROW	CONTACT CODE					
		1	2	3	4	5	6
74817-X018 SEE NOTE 15 LEAD FREE OPTION	E	03	02	02	01	01	01
	D	03	02	02	01	01	01
	C	03	02	02	03	03	03
	B	03	02	02	01	01	01
	A	03	02	02	01	01	01
	GND	01	01	01	01	01	01

METRAL P/N	ROW	CONTACT CODE					
		1	2	3	4	5	6
74817-X026 *RPU SEE NOTE 15 LEAD FREE OPTION	E	02	02	49	49	49	49
	D	02	02	49	49	49	49
	C	02	02	49	49	49	49
	B	02	02	49	49	49	49
	A	02	02	49	49	49	49
	GND	01	01	01	01	01	01

PCB THICKNESS RANGE FOR REAR PLUG UP APPLI.: 3.80 - 6.80 FOR METRAL 1000 RECEPTACLE APPLI. (NOT A STANDARD METRAL 1000 APPLI.) AND 2.30 (4.80) - 6.80 FOR METRAL 4000 APPLICATIONS

METRAL P/N	ROW	CONTACT CODE					
		1	2	3	4	5	6
74817-X031 SEE NOTE 15 LEAD FREE OPTION	E	02	02	02	02	02	02
	D	02	02	02	02	02	02
	C	19	19	19	19	19	19
	B	02	02	02	02	02	02
	A	01	03	02	03	02	02
	GND	01	01	01	01	01	01

METRAL P/N	ROW	CONTACT CODE					
		1	2	3	4	5	6
74817-X019 SEE NOTE 15 LEAD FREE OPTION	E	01	01	01	02	02	03
	D	01	01	01	02	02	03
	C	03	03	03	02	02	03
	B	01	01	01	02	02	03
	A	01	01	01	02	02	03
	GND	01	01	01	01	01	01

METRAL P/N	ROW	CONTACT CODE					
		1	2	3	4	5	6
74817-X027 *RPU SEE NOTE 15 LEAD FREE OPTION	E	49	49	49	49	02	02
	D	49	49	49	49	02	02
	C	49	49	49	49	02	02
	B	49	49	49	49	02	02
	A	49	49	49	49	02	02
	GND	01	01	01	01	01	01

PCB THICKNESS RANGE FOR REAR PLUG UP APPLI.: 3.80 - 6.80 FOR METRAL 1000 RECEPTACLE APPLI. (NOT A STANDARD METRAL 1000 APPLI.) AND 2.30 (4.80) - 6.80 FOR METRAL 4000 APPLICATIONS

METRAL P/N	ROW	CONTACT CODE					
		1	2	3	4	5	6
74817-X032 SEE NOTE 15 LEAD FREE OPTION	E	02	02	02	02	02	02
	D	02	02	02	02	02	02
	C	19	19	19	19	19	19
	B	02	02	02	02	02	02
	A	02	02	02	02	02	01
	GND	01	01	01	01	01	01



METRAL P/N	ROW	CONTACT CODE					
		1	2	3	4	5	6
74817-X023 ** SEE NOTE 15 LEAD FREE OPTION	E	01	03	03	03	01	01
	D	01	03	03	03	01	19
	C	01	01	01	01	01	19
	B	01	01	01	01	01	19
	A	01	01	01	19	19	19
	GND	01	01	01	01	01	01

METRAL P/N	ROW	CONTACT CODE					
		1	2	3	4	5	6
74817-X028 *RPU SEE NOTE 15 LEAD FREE OPTION	E	49	49	49	49	49	49
	D	49	49	49	49	49	49
	C	49	49	49	49	49	49
	B	49	49	49	49	49	49
	A	49	49	49	49	49	49
	GND	01	01	01	01	01	01

PCB THICKNESS RANGE FOR REAR PLUG UP APPLI.: 3.80 - 6.80 FOR METRAL 1000 APPLICATIONS, AND 4.80 - 6.80 FOR METRAL 4000 APPLICATIONS

METRAL P/N	ROW	CONTACT CODE					
		1	2	3	4	5	6
74817-X033 SEE NOTE 15 LEAD FREE OPTION	E	02	02	02	02	02	02
	D	02	02	02	02	02	02
	C	19	19	19	19	19	19
	B	02	02	02	02	02	02
	A	01	02	02	02	02	03
	GND	01	01	01	01	01	01

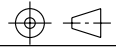
* REAR PLUG-UP PART NUMBER WITH PIN ALIGNER
 ** CANNOT BE MATED TO A METRAL 4000 RECEPTACLE
 *** REAR PLUG-UP PART NUMBER WITHOUT PIN ALIGNER

mat'l code SEE NOTE 5		tolerances unless otherwise specified		CUSTOMER	 www.fciconnect.com
ltr	ecn no.	dr	date	COPY	
AW				linear	projection
				0.X ± 0.3	 title VERTICAL SIGNAL HDR 5 ROW P.F. 30 POS. SELECT LOAD STD.
				0.XX ± 0.13	
				angles	 product family METRAL 1000 code size 213
				.XXX ± .051	
				0° ± 2°	74817 sheet 6
				dr	
				enrg	scale 2:1 A
				chr	
				appd	cage code 22526
sheet index	revision sheet				

This document is the property of and embodies CONFIDENTIAL and PROPRIETARY information of FCI. No part of the information shown on this document may be used in any way or disclosed to others without the written consent of FCI. Copyright FCI.



This document is the property of and embodies CONFIDENTIAL and PROPRIETARY information of FCI. No part of the information shown on this document may be used in any way or disclosed to others without the written consent of FCI. Copyright FCI.

METRAL P/N	ROW	CONTACT CODE					
		1	2	3	4	5	6
74817-X034 *RPU ** SEE NOTE 15 LEAD FREE OPTION	E	05	20	05	05	05	05
	D	05	20	05	05	05	05
	C	05	20	05	05	05	05
	B	05	20	05	05	05	05
	A	05	20	05	05	05	05
	GND	01	01	01	01	01	01

PCB THICKNESS RANGE FOR REAR PLUG UP APPLI.: 2.30 (2.95) - 5.30 (NOT A STANDARD METRAL 1000 APPLICATION). CANNOT BE MATED TO A METRAL 4000 RECEPTACLE.

METRAL P/N	ROW	CONTACT CODE					
		1	2	3	4	5	6
74817-X035 SEE NOTE 15 LEAD FREE OPTION	E	02	02	02	02	02	02
	D	02	02	02	02	02	02
	C	03	03	03	03	03	03
	B	01	02	02	02	02	02
	A	01	02	02	02	02	02
	GND	01	01	01	01	01	01

METRAL P/N	ROW	CONTACT CODE					
		1	2	3	4	5	6
74817-X036 SEE NOTE 15 LEAD FREE OPTION	E	02	02	02	02	02	02
	D	02	02	02	02	02	02
	C	01	01	01	01	03	02
	B	01	01	02	02	02	02
	A	02	02	02	02	02	02
	GND	01	01	01	01	01	01

METRAL P/N	ROW	CONTACT CODE					
		1	2	3	4	5	6
74817-X037 SEE NOTE 15 LEAD FREE OPTION	E	02	02	02	02	02	02
	D	02	02	02	02	02	02
	C	01	02	02	02	02	02
	B	01	01	01	01	01	01
	A	02	02	02	02	02	02
	GND	01	01	01	01	01	01

METRAL P/N	ROW	CONTACT CODE					
		1	2	3	4	5	6
74817-X038 SEE NOTE 15 LEAD FREE OPTION	E	02	02	02	02	02	02
	D	02	02	02	02	02	02
	C	02	02	02	02	02	02
	B	02	02	02	02	02	02
	A	02	02	02	03	02	02
	GND	-	-	-	-	-	-

METRAL P/N	ROW	CONTACT CODE					
		1	2	3	4	5	6
74817-X039 ** SEE NOTE 15 LEAD FREE OPTION	E	01	01	01	01	01	01
	D	01	01	01	01	01	01
	C	01	01	01	01	01	01
	B	01	01	01	01	01	01
	A	01	04	01	01	01	01
	GND	01	01	01	01	01	01

METRAL P/N	ROW	CONTACT CODE					
		1	2	3	4	5	6
74817-X040 *RPU ** SEE NOTE 15 LEAD FREE OPTION	E	08	06	06	06	06	06
	D	08	06	06	06	06	06
	C	06	06	06	06	06	06
	B	08	06	06	06	06	06
	A	08	06	06	06	06	06
	GND	06	06	06	06	06	06

METRAL P/N	ROW	CONTACT CODE					
		1	2	3	4	5	6
74817-X041 ** SEE NOTE 15 LEAD FREE OPTION	E	02	02	02	02	04	02
	D	02	02	02	02	02	02
	C	02	02	02	02	02	04
	B	02	02	02	02	02	02
	A	02	02	02	02	02	04
	GND	01	01	01	01	01	01

METRAL P/N	ROW	CONTACT CODE					
		1	2	3	4	5	6
74817-X042 *RPU ** SEE NOTE 15 LEAD FREE OPTION	E	08	06	06	06	06	06
	D	08	06	06	06	06	06
	C	08	06	06	06	06	06
	B	08	06	06	06	06	06
	A	08	06	06	06	06	06
	GND	30	30	30	30	30	30

METRAL P/N	ROW	CONTACT CODE					
		1	2	3	4	5	6
74817-X043 ** SEE NOTE 15 LEAD FREE OPTION	E	03	03	03	03	03	03
	D	03	03	03	03	01	03
	C	03	03	03	03	03	03
	B	03	03	03	03	03	03
	A	19	19	19	19	19	19
	GND	01	01	01	01	01	01

PCB THICKNESS RANGE FOR REAR PLUG UP APPLICATIONS: 4.00 - 5.30. CANNOT BE MATED TO A METRAL 4000 RECEPTACLE.

PCB THICKNESS RANGE FOR REAR PLUG UP APPLICATIONS: 3.25 - 4.95 FOR METRAL 1000 APPLICATIONS. CANNOT BE MATED TO A METRAL 4000 RECEPTACLE.

METRAL P/N	ROW	CONTACT CODE					
		1	2	3	4	5	6
74817-X044 *RPU ** SEE NOTE 15 LEAD FREE OPTION	E	45	45	45	45	45	45
	D	45	45	45	45	22	45
	C	45	45	45	45	45	45
	B	45	45	45	45	45	45
	A	47	47	47	47	47	47
	GND	22	22	22	22	22	22

PCB THICKNESS RANGE FOR REAR PLUG UP APPLI.: 2.95 - 3.80 FOR MATING TO METRAL 1000 RECEPTACLE. CANNOT BE MATED TO METRAL 4000 RECEPTACLES.

METRAL P/N	ROW	CONTACT CODE					
		1	2	3	4	5	6
74817-X045 SEE NOTE 15 LEAD FREE OPTION	E	02	02	02	02	02	02
	D	02	02	02	02	02	02
	C	02	02	02	02	02	2
	B	02	02	02	02	02	02
	A	02	01	02	02	02	02
	GND	01	01	01	01	01	01

METRAL P/N	ROW	CONTACT CODE					
		1	2	3	4	5	6
74817-X046 *RPU SEE NOTE 15 LEAD FREE OPTION	E	22	22	22	22	22	22
	D	22	22	22	22	22	22
	C	45	45	45	45	45	45
	B	22	22	22	22	22	22
	A	22	22	22	22	22	22
	GND	01	22	22	22	22	01

PCB THICKNESS RANGE FOR REAR PLUG UP APPLI.: 2.95 - 3.80 FOR BOTH METRAL 1000 AND 4000 RECEPTACLE MATING (NOT A STANDARD METRAL 1000 APPLICATION)

METRAL P/N	ROW	CONTACT CODE					
		1	2	3	4	5	6
74817-X047 SEE NOTE 15 LEAD FREE OPTION	E	02	01	02	02	02	02
	D	02	02	02	02	02	02
	C	02	02	02	02	02	02
	B	02	02	02	02	02	02
	A	02	02	02	02	02	02
	GND	01	01	01	01	01	01

METRAL P/N	ROW	CONTACT CODE					
		1	2	3	4	5	6
74817-X048 SEE NOTE 15 LEAD FREE OPTION	E	02	02	02	02	02	02
	D	02	02	02	02	02	02
	C	02	02	02	02	02	04
	B	02	02	02	02	02	02
	A	02	02	02	02	02	02
	GND	02	02	02	02	02	02

- * REAR PLUG-UP PART NUMBER WITH PIN ALIGNER
- ** CANNOT BE MATED TO A METRAL 4000 RECEPTACLE
- *** REAR PLUG-UP PART NUMBER WITHOUT PIN ALIGNER

mat'l code		SEE NOTE 5		tolerances unless otherwise specified		CUSTOMER	FCI	
ltr	ecr no.	dr	date	linear	0.X ±0.3	COPY	www.fciconnect.com	
AW				linear	0.XX ±0.13	projection	title	
				angles	.XXX ±.051		VERTICAL SIGNAL HDR 5 ROW	
				dr	0° ±2°		P.F. 30 POS. SELECT LOAD STD.	
				enrg	K. BELL 2000-03-29	MM	product family	METRAL 1000
				chr	M. HAHN 2000-03-29		size	code
				appd	M. HAHN 2000-03-29	scale	dwg no	213
sheet	revision					2:1	A	74817
index	sheet							7

METRAL P/N	ROW	CONTACT CODE					
		1	2	3	4	5	6
74817-X049 SEE NOTE 15 LEAD FREE OPTION	E	02	02	02	02	02	02
	D	02	02	02	02	02	02
	C	04	02	02	02	02	02
	B	02	02	02	02	02	02
	A	02	02	02	02	02	02
	GND	02	02	02	02	02	02

METRAL P/N	ROW	CONTACT CODE					
		1	2	3	4	5	6
74817-X054 ***RPU SEE NOTE 15 LEAD FREE OPTION	E	22	22	22	22	22	22
	D	22	22	22	22	22	22
	C	45	45	45	45	45	45
	B	22	22	22	22	22	22
	A	22	22	22	22	22	22
	GND	01	22	22	22	22	01

METRAL P/N	ROW	CONTACT CODE					
		1	2	3	4	5	6
74817-X050 ** SEE NOTE 15 LEAD FREE OPTION	E	02	02	02	02	02	04
	D	02	02	02	02	02	04
	C	02	02	02	02	02	04
	B	02	02	02	02	02	04
	A	02	01	02	02	02	04
	GND	02	02	02	02	02	02

METRAL P/N	ROW	CONTACT CODE					
		1	2	3	4	5	6
74817-X055 ** SEE NOTE 15 LEAD FREE OPTION	E	04	02	02	02	02	02
	D	04	02	02	02	02	02
	C	04	02	02	02	02	02
	B	04	02	02	02	02	02
	A	04	02	02	02	02	02
	GND	-	02	02	02	02	-

METRAL P/N	ROW	CONTACT CODE					
		1	2	3	4	5	6
74817-X051 ** SEE NOTE 15 LEAD FREE OPTION	E	04	02	02	02	02	02
	D	04	02	02	02	02	02
	C	04	02	02	02	02	02
	B	04	02	02	02	02	02
	A	04	01	02	02	02	02
	GND	02	02	02	02	02	02

METRAL P/N	ROW	CONTACT CODE					
		1	2	3	4	5	6
74817-X056 SEE NOTE 15 LEAD FREE OPTION	E	02	02	02	02	02	02
	D	02	02	02	02	02	02
	C	04	02	02	02	02	02
	B	02	02	02	02	02	02
	A	02	02	02	02	02	02
	GND	-	02	02	02	02	-

METRAL P/N	ROW	CONTACT CODE					
		1	2	3	4	5	6
74817-X052 ***RPU SEE NOTE 15 LEAD FREE OPTION	E	05	05	05	05	05	05
	D	05	05	05	05	05	05
	C	05	05	05	05	05	05
	B	05	05	05	05	05	05
	A	05	05	05	05	05	05
	GND	01	01	01	01	01	01

METRAL P/N	ROW	CONTACT CODE					
		1	2	3	4	5	6
74817-X057 *RPU SEE NOTE 15 LEAD FREE OPTION	E	22	22	22	01	01	01
	D	22	22	22	01	01	01
	C	22	22	22	01	01	01
	B	22	22	22	01	01	01
	A	22	22	22	01	01	01
	GND	22	22	22	22	22	22

METRAL P/N	ROW	CONTACT CODE					
		1	2	3	4	5	6
74817-X053 ***RPU SEE NOTE 15 LEAD FREE OPTION	E	05	20	05	05	05	05
	D	05	20	05	05	05	05
	C	05	20	05	05	05	05
	B	05	20	05	05	05	05
	A	05	20	05	05	05	05
	GND	01	01	01	01	01	01

* REAR PLUG-UP PART NUMBER WITH PIN ALIGNER
 ** CANNOT BE MATED TO A METRAL 4000 RECEPTACLE
 *** REAR PLUG-UP PART NUMBER WITHOUT PIN ALIGNER

mat'l code		SEE NOTE 5		tolerances unless otherwise specified		CUSTOMER		FCJ www.fciconnect.com	
ltr	ecn no.	dr	date	linear	0.X ± 0.3	COPY		title	
AW				linear	0.XX ± 0.13	projection		VERTICAL SIGNAL HDR 5 ROW	
				angles	.XXX ± .051			P.F. 30 POS. SELECT LOAD STD.	
				dr	K. BELL 2000-03-29	MM		product family METRAL 1000	
				engr	J. VOLSTORF 2001-05-23			code	
				chr	M. HAHN 2000-03-29	2:1		213	
				appd	M. HAHN 2000-03-29	A		sheet	
sheet index	revision sheet							8	



This document is the property of and embodies CONFIDENTIAL and PROPRIETARY information of FCJ. No part of the information shown on this document may be used in any way or disclosed to others without the written consent of FCJ. Copyright FCJ.

PRODUCT NUMBER
SEE SHEET 1



NOTES:

1. SEE APPLICATION SPECIFICATION GS-20-010 FOR INFORMATION ON AVAILABLE TOOLING, CIRCUIT BOARD DESIGN CONSIDERATIONS, REPAIR PROCEDURES AND PRODUCT OFFERINGS.
2. SEE FCI PUBLICATION 950511-028 FOR "ELECTRICAL PERFORMANCE DATA FOR DIFFERENTIAL APPLICATIONS."
3. SEE FCI PUBLICATION 950511-029 FOR "ELECTRICAL PERFORMANCE DATA FOR SINGLE-ENDED APPLICATION."
4. UNLESS OTHERWISE SPECIFIED, ALL DIMENSIONS AND TOLERANCES ARE IN ACCORDANCE WITH ASME Y14.5, 1994
5. HOUSING MATERIAL: LIQUID CRYSTAL POLYMER, 30% GLASS FILLED, FLAME RETARDANT PER UL 94-V0.
PIN MATERIAL: PHOSPHER BRONZE
GROUND SPRING MATERIAL: PHOSPHER BRONZE
6. PLATING INFORMATION: PLATING ON CONTACT AREA MEETS THE PERFORMANCE LEVELS SHOWN IN TABLE ON SHEET 1. PLATING OF "LF" TAILS IS Sn. PLATING ON ALL OTHER TAILS IS SnPb.
7. DIMENSIONAL RESTRICTIONS OF PINS IN HEADERS.
FOR MATING WITH METRAL 1000 RECEPTACLES
DIM A : 5.00mm MIN, 8.00mm MAX FOR ROWS A-E
DIM A : 5.00mm MIN, 5.75mm MAX FOR ROW GND NEXT TO ROW A
DIM C : 5.00mm MIN, 8.00mm MAX FOR ROWS A-E
DIM C : 4.60mm MIN, 6.30mm MAX FOR ROW GND NEXT TO ROW A
FOR MATING WITH METRAL 4000 RECEPTACLES
DIM A : 5.00mm MIN, 6.50mm MAX FOR ROWS A, B, D & E
DIM A : 5.00mm MIN, 8.00mm MAX FOR ROW C
DIM A : 5.00mm MIN, 5.75mm MAX FOR ROW GND NEXT TO ROW A
DIM C : 5.00mm MIN, 7.00mm MAX FOR ROWS A, B, D & E
DIM C : 5.00mm MIN, 8.00mm MAX FOR ROW C
DIM C : 4.60mm MIN, 6.30mm MAX FOR ROW GND NEXT TO ROW A

8. THE MIN PCB THICKNESS FOR REAR PLUG-UP APPLICATIONS IS 2.9mm SINCE THE COMPLAINT SECTIONS OF THE GROUND SPRING OF THE HEADER DIRECTLY OPPOSE THE GROUND SPRING OF THE SHROUD. THE MIN PCB THICKNESS FOR FRONT PLUG-UP ONLY APPLICATIONS IS 1.6mm.
9. THESE HOLES ARE NEEDED FOR REAR PLUG-UP DESIGNS USING A SHROUD AND MAY BE OMITTED FOR FRONT PLUG-UP ONLY DESIGNS.
10. THE 'CONNECTOR OUTLINE' IS THE MIN OUTLINE REQUIRED. TO DETERMINE THE OUTLINE NECESSARY TO PERMIT THE VARIOUS TYPES OF REPAIR OPERATIONS, SEE APPLICATION SPECIFICATION GS-20-010.
11. CURRENT RATING: 1 AMP PER PIN
12. TEMPERATURE RANGE: -55°C TO +105°C
13. P/N 74817-XZZZLF

14. THE PRODUCTS WHERE THE PART NUMBERS ENDS IN LF MEET EUROPEAN UNION DIRECTIVES AND OTHER COUNTRY REGULATIONS AS DESCRIBED IN GS-22-008. ALL PRODUCTS WILL WITHSTAND EXPOSURE TO 260°C FOR 60 SECONDS IN A CONVECTION, INFRA-RED OR VAPOR PHASE REFLOW OVEN.
15. FOR LEAD FREE PART NUMBERS ADD 'LF' SUFFIX. EXAMPLE: 74817-XXXXLF
16. PIN TYPE IS AT THE MANUFACTURERS OPTION AND CAN BE EITHER BABY-H OR EYE OF THE NEEDLE STYLE

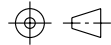

This document is the property of and embodies CONFIDENTIAL and PROPRIETARY information of FCI. No part of the information shown on this document may be used in any way or disclosed to others without the written consent of FCI. Copyright FCI.

mat'l code SEE NOTE 5				tolerances unless otherwise specified		CUSTOMER		 www.fciconnect.com	
ltr	ecr no.	dr	date	linear	0.X ±0.3	COPY		title VERTICAL SIGNAL HDR 5 ROW P.F. 30 POS. SELECT LOAD STD.	
AW					0.XX ±0.13	projection			
					.XXX ±.051				
				angles	0° ±2°			product family METRAL 1000 code	
				dr	K. BELL 2000-03-29	scale		size	
				engr	M. HAHN 2000-03-29	1:1		dwg no	
				chr	M. HAHN 2000-03-29	A		74817	
				appd	M. HAHN 2000-03-29			sheet	
sheet index		revision sheet						9	

Mouser Electronics

Authorized Distributor

Click to View Pricing, Inventory, Delivery & Lifecycle Information:

[FCI / Amphenol:](#)

[74817-9013LF](#)