

## DATASHEET

# QBVW033A0B Barracuda\* Series; DC-DC Converter Power Modules

**36-75V<sub>dc</sub> Input; 12.0V<sub>dc</sub>, 33.0A, 400W Output**

RoHS Compliant



## Description

The QBVW033A0B series of dc-dc converters are a new generation of fully regulated DC/DC power modules designed to support 12V<sub>dc</sub> intermediate bus applications where multiple low voltages are subsequently generated using point of load (POL) converters, as well as other application requiring a tightly regulated output voltage. The QBVW033A0B series operate from an input voltage range of 36 to 75V<sub>dc</sub> and provide up to 33A output current at output

voltages of 12V<sub>dc</sub> in an industry standard, DOSA compliant quarter brick. The converter incorporates digital control, synchronous rectification technology, a fully regulated control topology, and innovative packaging techniques to achieve efficiency exceeding 96% at 12V output. This leads to lower power dissipations such that for many applications a heat sink is not required. Standard features include on/off control, output overcurrent and over voltage protection, over temperature protection, input under and over voltage lockout.

The output is fully isolated from the input, allowing versatile polarity configurations and grounding connections. Built-in filtering for both input and output minimizes the need for external filtering.

## Applications

- Distributed power architectures
- Intermediate bus voltage applications
- Servers and storage applications
- Networking equipment including Power over Ethernet (PoE)
- Fan assemblies and other systems requiring a tightly regulated output voltage

## Options

- Negative Remote On/Off logic (1=option code, factory preferred)
- Auto-restart after fault shutdown (4=option code, factory preferred)
- Remote Sense and Output Voltage Trim (9=option code)
- Base plate option (-H=option code)

## Features

- Compliant to RoHS Directive 2011/65/EU and amended Directive (EU) 2015/863 (-Z versions)
- Compliant to REACH Directive (EC) No 1907/2006
- Compatible with reflow pin/paste soldering process
- High and flat efficiency profile >95.5% at 12V<sub>dc</sub>, 30% load to 100% output
- Wide Input voltage range: 36-75V<sub>dc</sub>
- Delivers up to 33A<sub>dc</sub> output current
- Fully very tightly regulated output voltage
- Low output ripple and noise
- Industry standard, DOSA Compliant Quarter Brick:  
58.4 mm x 36.8 mm x 11.7 mm  
(2.30 in x 1.45 in x 0.46 in)
- Constant switching frequency
- Positive Remote On/Off logic
- Output over current/voltage protection
- Over temperature protection
- Wide operating temperature range (-40°C to 85°C)
- ANSI/UL# 62368-1 and CAN/CSA† C22.2 No. 62368-1 Recognized, DIN VDE‡ 0868-1/A11:2017 (EN62368-1:2014/A11:2017)
- CE mark to 2014/35/EU directive§
- Meets the voltage and current requirements for ETSI 300-132-2 and complies with and licensed for Basic insulation rating
- 2250 V<sub>dc</sub> Isolation tested in compliance with IEEE 802.3‖ PoE standards
- ISO\*\* 9001 and ISO14001 certified manufacturing facilities

### FOOTNOTE

\* Trademark of OmniOn Company

# UL is a registered trademark of Underwriters Laboratories, Inc.

† CSA is a registered trademark of Canadian Standards Association.

‡ VDE is a trademark of Verband Deutscher Elektrotechniker e.V.

§ This product is intended for integration into end-user equipment. All of the required procedures of end-use equipment should be followed.

‖ IEEE and 802 are registered trademarks of the Institute of Electrical and Electronics Engineers, Incorporated.

\*\* ISO is a registered trademark of the International Organization of Standards.

## Technical Specifications

### Absolute Maximum Ratings

Stresses in excess of the absolute maximum ratings can cause permanent damage to the device. These are absolute stress ratings only, functional operation of the device is not implied at these or any other conditions in excess of those given in the operations sections of the Data Sheet. Exposure to absolute maximum ratings for extended periods can adversely affect device reliability.

Parameter	Device	Symbol	Min	Max	Unit
Input Voltage*					
Continuous		$V_{IN}$	-0.3	75	$V_{dc}$
Operating transient $\leq 100\text{ms}$				100	$V_{dc}$
Non- operating continuous		$V_{IN}$	80	100	$V_{dc}$
Operating Ambient Temperature (See Thermal Considerations section)	All	$T_A$	-40	85	$^{\circ}\text{C}$
Storage Temperature	All	$T_{stg}$	-55	125	$^{\circ}\text{C}$
I/O Isolation Voltage (100% factory Hi-Pot tested)	All	—	—	2250	$V_{dc}$

\*Input over voltage protection will shutdown the output voltage when the input voltage exceeds threshold level.

### Electrical Specifications

Unless otherwise indicated, specifications apply over all operating input voltage, resistive load, and temperature conditions.

Parameter	Device	Symbol	Min	Typ	Max	Unit
Operating Input Voltage		$V_{IN}$	36	48	75	$V_{dc}$
Maximum Input Current ( $V_{IN}=0\text{V}$ to $75\text{V}$ , $I_O=I_{O,max}$ )		$I_{IN,max}$	—	—	12	$A_{dc}$
Input No Load Current ( $V_{IN} = V_{IN,nom}$ , $I_O = 0$ , module enabled)	All	$I_{IN,No\ load}$		80		mA
Input Stand-by Current ( $V_{IN} = V_{IN,nom}$ , module disabled)	All	$I_{IN,stand-by}$			22	mA
External Input Capacitance	All		100	—	—	$\mu\text{F}$
Inrush Transient	All	$I^2t$	—	—	1	$A^2s$
Input Terminal Ripple Current (Measured at module input pin with maximum specified input capacitance and $< 500\mu\text{H}$ inductance between voltage source and input capacitance) 5Hz to 20MHz, $V_{IN}= 48\text{V}$ , $I_O= I_{Omax}$	All		—	350	—	$\text{mA}_{rms}$
Input Reflected Ripple Current, peak-to-peak (5Hz to 20MHz, $12\mu\text{H}$ source impedance; $V_{IN}= 48\text{V}$ , $I_O= I_{Omax}$ ; see Figure 11)	All		—	40	—	$\text{mA}_{p-p}$
Input Ripple Rejection (120Hz)	All		—	25	—	dB

#### CAUTION: This power module is not internally fused. An input line fuse must always be used.

This power module can be used in a wide variety of applications, ranging from simple standalone operation to an integrated part of sophisticated power architecture. To preserve maximum flexibility, internal fusing is not included, however, to achieve maximum safety and system protection, always use an input line fuse. The safety agencies require a fast-acting fuse with a maximum rating of 30A in the ungrounded input lead of the power supply (see Safety Considerations section). Based on the information provided in this Data Sheet on inrush energy and maximum dc input current, the same type of fuse with a lower rating can be used. Refer to the fuse manufacturer's Data Sheet for further information.

## Technical Specifications (continued)

### Electrical Specifications (continued)

Unless otherwise indicated, specifications apply over all operating input voltage, resistive load, and temperature conditions.

Parameter	Device	Symbol	Min	Typ	Max	Units
Output Voltage Set-point ( $V_{IN}=V_{IN,nom}$ , $I_O=16.5A$ , $T_A=25^\circ C$ )	All	$V_{O,set}$	11.97	12.00	12.03	$V_{dc}$
Output Voltage (Over all operating input voltage (40V to 75V), resistive load, and temperature conditions until end of life)	All w/o P Option	$V_O$	11.76	—	12.24	$V_{dc}$
	All w/ P Option	$V_O$	11.63	—	12.37	$V_{dc}$
Output Voltage ( $V_{IN}=36V$ , $T_A=25^\circ C$ )	All	$V_O$	11.00	—	—	$V_{dc}$
Output Regulation [ $V_{IN,min}=40V$ ]						
Line ( $V_{IN}=V_{IN,min}$ to $V_{IN,max}$ )	All w/o 9 Option		—	0.2	—	$\%V_{O,set}$
Line ( $V_{IN}=V_{IN,min}$ to $V_{IN,max}$ )	All w/o 9 Option		—	0.5	—	$\%V_{O,set}$
Load ( $I_O=I_{O,min}$ to $I_{O,max}$ )	All w/o P or 9 Option		—	0.2	—	$\%V_{O,set}$
Load ( $I_O=I_{O,min}$ to $I_{O,max}$ )	All w/o 9 Option		—	1.2	—	$\%V_{O,set}$
Load ( $I_O=I_{O,min}$ to $I_{O,max}$ ), Intentional Droop	All w/p Option		—	0.50	—	$V_{dc}$
Temperature ( $T_A=-40^\circ C$ to $+85^\circ C$ )	All		—	2	—	$\%V_{O,set}$
Output Ripple and Noise, on nominal Output ( $V_{IN}=V_{IN,nom}$ and $I_O=I_{O,min}$ to $I_{O,max}$ )						
RMS (5Hz to 20MHz bandwidth)	All		—	70	—	$mV_{rms}$
Peak-to-Peak (5Hz to 20MHz bandwidth)	All		—	200	—	$mV_{pk-pk}$
External Output Capacitance For $C_O > 5000\mu F$ , $I_O$ must be $< 50\% I_{O,max}$ during $T_{rise}$ . When 2 or more modules are in parallel	All -P Option	$C_{O,max}$	0 0	—	10,000 15,000	$\mu F$ $\mu F$
Output Current	All	$I_O$	0		33	A
Output Current Limit Inception	All	$I_{O,lim}$	36.3	40	—	$A_{dc}$
Efficiency ( $V_{IN}=48V$ , $T_A=25^\circ C$ ) $I_O=100\% I_{O,max}$ , $V_O=V_{O,set}$ $I_O=40\% I_{O,max}$ to $75\% I_{O,max}$ , $V_O=V_{O,set}$	All All	$\eta$		95.5 96.0		%
Switching Frequency (Primary FETs)		$f_{sw}$		170		kHz
Dynamic Load Response $dI_O/dt=1A/\mu s$ ; $V_{in}=V_{in,nom}$ ; $T_A=25^\circ C$ ; (Tested with a $1.0\mu F$ ceramic, and $470\mu F$ capacitor at the load.) Load Change from $I_O=50\%$ to $75\%$ of $I_{O,max}$ :						
Peak Deviation	All	$V_{pk}$	—	500	—	$mV_{pk}$
Settling Time ( $V_O < 10\%$ peak deviation)		$t_s$	—	700	—	$\mu s$
Load Change from $I_O=75\%$ to $50\%$ of $I_{O,max}$ :						
Peak Deviation	All	$V_{pk}$	—	500	—	$mV_{pk}$
Settling Time ( $V_O < 10\%$ peak deviation)		$t_s$	—	700	—	$\mu s$

### General Specifications

Parameter	Symbol	Device	Typ	Unit
Calculated Reliability Based upon Telcordia SR-332 Issue 3: Method I, Case 3, ( $I_O=80\% I_{O,max}$ , $T_A=40^\circ C$ , Airflow = 200 LFM), 90% confidence	MTBF	All	3,108,685	Hours
	FIT	All	321.7	$10^9$ /Hours
Weight – Open Frame			47.4 (1.67)	g (oz.)
Weight – with Base plate option			66.4 (2.34)	g (oz.)

## Technical Specifications (continued)

### Isolation Specifications

Parameter	Symbol	Min	Typ	Max	Unit
Isolation Capacitance	$C_{iso}$	—	1000	—	pF
Isolation Resistance	$R_{iso}$	10	—	—	M $\Omega$

### Feature Specifications

Unless otherwise indicated, specifications apply over all operating input voltage, resistive load, and temperature conditions.

Parameter	Device	Symbol	Min	Typ	Max	Unit
Remote On/Off Signal Interface ( $V_{IN}=V_{IN, min}$ to $V_{IN, max}$ , Signal referenced to $V_{IN-}$ terminal) Negative Logic: device code suffix "1" Logic Low = module On, Logic High = module Off Positive Logic: No device code suffix required Logic Low = module Off, Logic High = module On Logic Low Specification On/Off Thresholds:						
Remote On/Off Current – Logic Low ( $V_{in}=100V$ )	All	$I_{on/off}$	280	—	310	$\mu A$
Logic Low Voltage	All	$V_{on/off}$	-0.3	—	0.8	$V_{dc}$
Logic High Voltage – (Typ = Open Collector)	All	$V_{on/off}$	2.0	—	14.5	$V_{dc}$
Logic High maximum allowable leakage current ( $V_{on/off}=2.0V$ )	All	$I_{on/off}$	—	—	10	$\mu A$
Maximum voltage allowed on On/Off pin	All	$V_{on/off}$	—	—	14.5	$V_{dc}$
Turn-On Delay and Rise Times ( $I_o=I_{o, max}$ )  $T_{delay}$ =Time until $V_o=10\%$ of $V_{o, set}$ from either application of $V_{in}$ with Remote On/Off set to On (Enable with $V_{in}$ ); or operation of Remote On/Off from Off to On with $V_{in}$ already applied for at least 30 milli-seconds (Enable with on/off). * Increased $T_{delay}$ due to startup for parallel modules.	All w/o P option All w/o P option All w/o P option All w/o P option	$T_{delay, Enable with V_{in}}$ $T_{delay, Enable with on/off}$ $T_{delay, Enable with V_{in}}$ $T_{delay, Enable with on/off}$	— — — —	— — — —	150 10 180* 40*	ms ms ms ms
$T_{rise}$ =Time for $V_o$ to rise from 10% to 90% of $V_{o, set}$ , For $C_o > 5000\mu F$ , $I_o$ must be $< 50\% I_{o, max}$ during $T_{rise}$ . * Increased $T_{rise}$ when pre-bias $V_o$ exists at startup for parallel modules.	All w/o P option All w/ P option	$T_{rise}$ $T_{rise}$	— —	— —	15 300*	ms ms
Remote Sense Range	All w/ 9 option	$V_{Sense}$	—	—	0.5	$V_{dc}$
Load Sharing Current Balance (difference in output current across all modules with outputs in parallel, no load to full load)	P option	$I_{diff}$			3	A
Output Voltage Adjustment Range	All w/ 9 option	$V_{O, set}$	8.1		13.2	$V_{dc}$
Output Overvoltage Protection	All w/o P option	$V_{O, limit}$	14.5		17.0	$V_{dc}$
	All w/o P option	$V_{O, limit}$	$V_{O, set}+2.5V$		$V_{O, set}+5.0V$	$V_{dc}$
Overtemperature Protection (See Feature Descriptions)	All	$T_{ref}$	—	140	—	$^{\circ}C$
Input Undervoltage Lockout						
Turn-on Threshold			33	35	36	$V_{dc}$
Turn-off Threshold			31	33	34	$V_{dc}$
Input Overvoltage Lockout						
Turn-off Threshold			—	86	—	$V_{dc}$
Turn-on Threshold			76	79	—	$V_{dc}$

## Technical Specifications (continued)

### Characteristic Curves, 12.0V<sub>dc</sub> Output

The following figures provide typical characteristics for the QBVW033A0B (12V, 33A) at 25°C. The figures are identical for either positive or negative Remote On/Off logic.

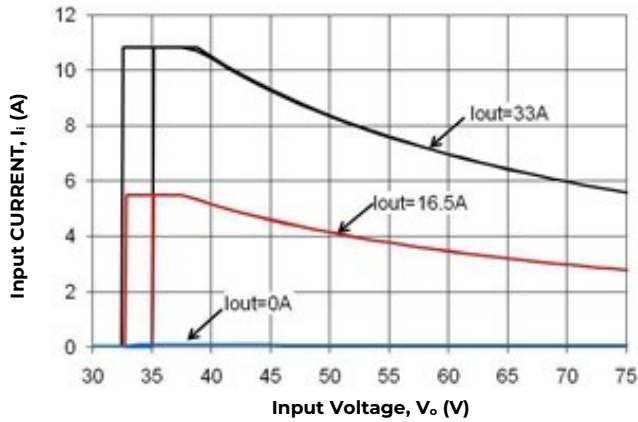

Figure 1. Typical Input Characteristic.

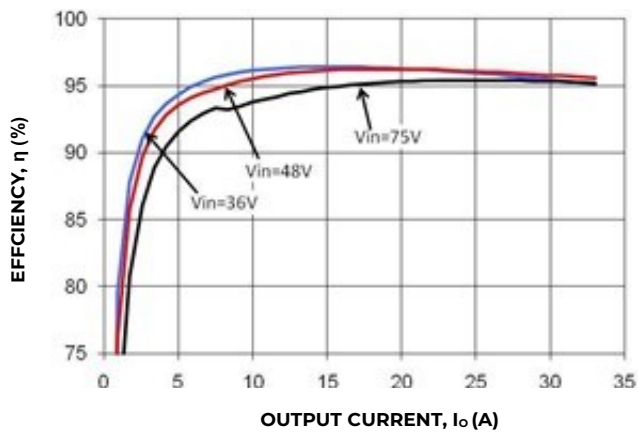

Figure 2. Typical Converter Efficiency vs. Output Current.

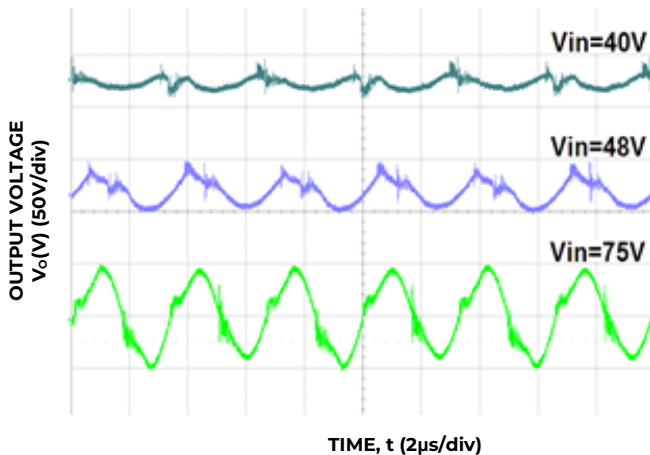

Figure 3. Typical Output Ripple and Noise,  $I_o = I_{o,max}$

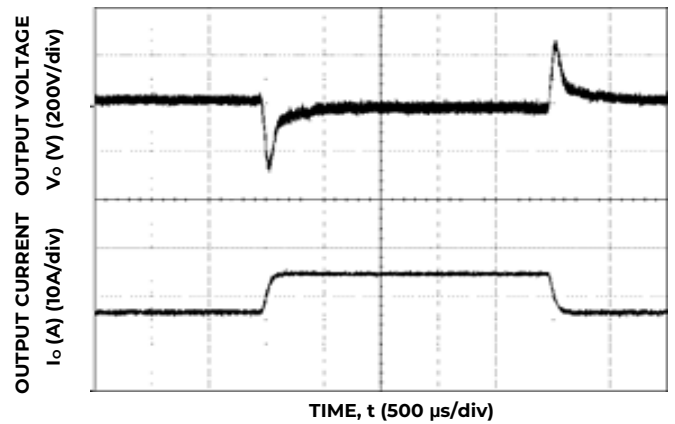

Figure 4. Typical Transient Response to 0.1A/μs Step Change in Load from 50% to 75% to 50% of Full Load,  $C_o=470\mu F$  and 48 V<sub>dc</sub> Input.

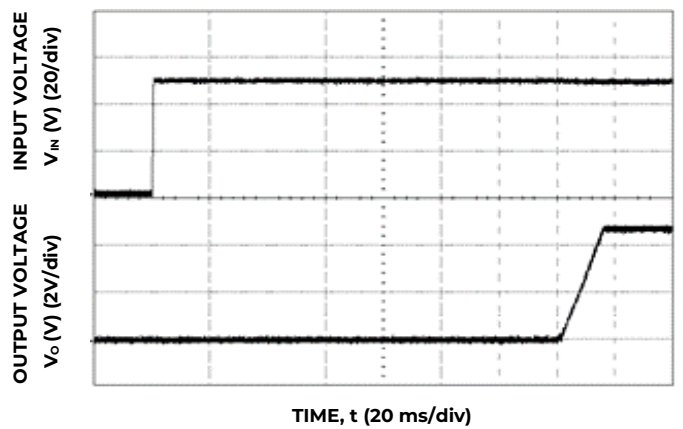

Figure 5. Typical Start-Up Using  $V_{in}$  with Remote On/Off enabled, negative logic version shown.

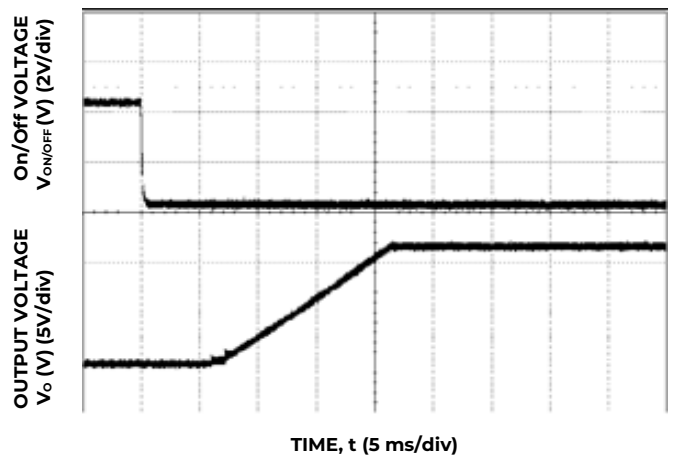

Figure 6. Typical Start-Up Using Remote On/Off with  $V_{in}$  applied, negative logic version shown.

## Technical Specifications (continued)

### Characteristic Curves, 12.0V<sub>dc</sub> Output (continued)

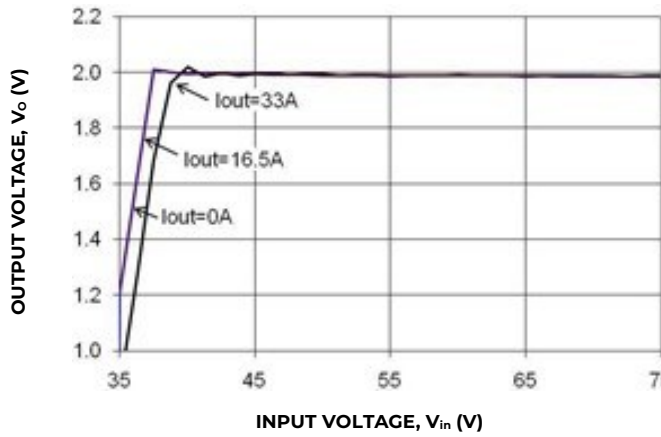

Figure 7. Typical Output Voltage Regulation vs. Input Voltage.

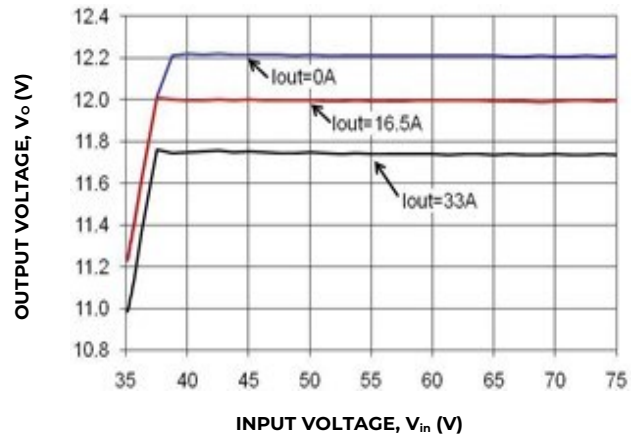

Figure 9. Typical Output Voltage Regulation vs. Input Voltage for the -P Version.

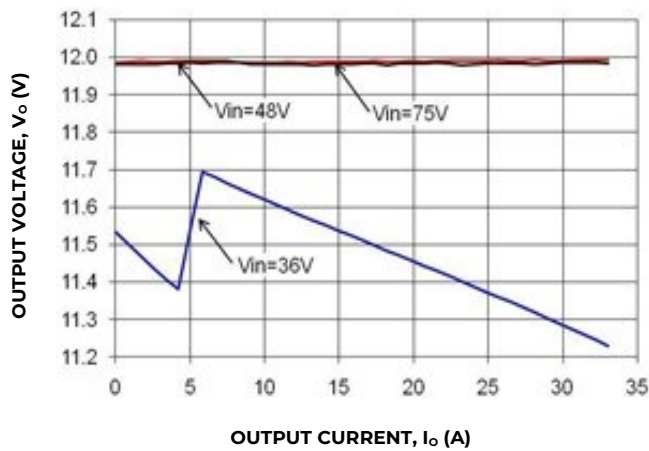

Figure 8. Typical Output Voltage Regulation vs. Output Current.

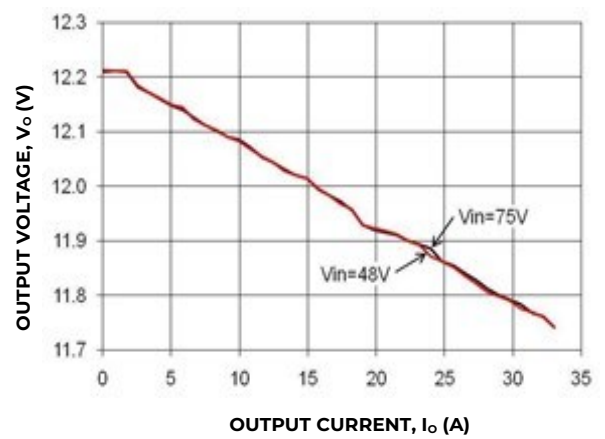

Figure 10. Typical Output Voltage Regulation vs. Output Current for the -P Version.



# Technical Specifications (continued)

## Test Configurations

$$\eta = \left( \frac{[V_o(+)-V_o(-)]I_o}{[V_i(+)-V_i(-)]I_i} \right) \times 100$$

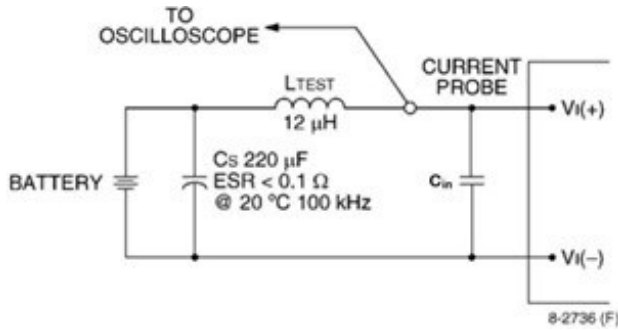

**Figure 11. Input Reflected Ripple Current Test Setup.**

Note: Measure input reflected-ripple current with a simulated source inductance (LTEST) of 12 μH. Capacitor Cs offsets possible battery impedance. Measure current as shown above.

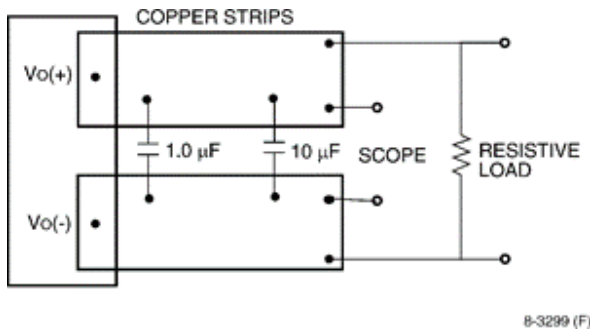

**Figure 12. Output Ripple and Noise Test Setup.**

Note: Use a 1.0 μF ceramic capacitor, a 10 μF aluminum or tantalum capacitor and a 750 polymer capacitor. Scope measurement should be made using a BNC socket. Position the load between 51 mm and 76 mm (2 in. and 3 in.) from the module.

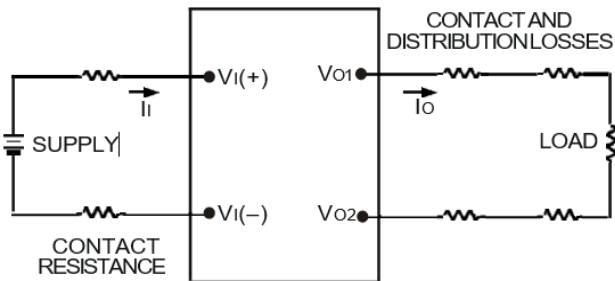

**Figure 13. Output Voltage and Efficiency Test**

Note: All measurements are taken at the module terminals. When socketing, place Kelvin connections at module terminals to avoid measurement errors due to socket contact resistance.

## Design Considerations

### Input Source Impedance

The power module should be connected to a low ac-impedance source. Highly inductive source impedance can affect the stability of the power module. For the test configuration in Figure 11, a 100μF electrolytic capacitor, Cin, (ESR<0.7Ω at 100kHz), mounted close to the power module helps ensure the stability of the unit.

### Safety Considerations

For safety agency approval the power module must be installed in compliance with the spacing and separation requirements of the end-use safety agency standards, i.e., UL ANSI/UL\* 62368-1 and CAN/CSA+ C22.2 No. 62368-1 Recognized, DIN VDE 0868-1/A11:2017 (EN62368-1:2014/A11:2017) If the input source is non-SELV (ELV or a hazardous voltage greater than 60 V<sub>dc</sub> and less than or equal to 75V<sub>dc</sub>), for the module's output to be considered as meeting the requirements for safety extra-low voltage (SELV) or ES1, all of the following must be true:

- The input source is to be provided with reinforced insulation from any other hazardous voltages, including the ac mains.
- One V<sub>IN</sub> pin and one V<sub>OUT</sub> pin are to be grounded, or both the input and output pins are to be kept floating.
- The input pins of the module are not operator accessible.
- Another SELV or ES1 reliability test is conducted on the whole system (combination of supply source and subject module), as required by the safety agencies, to verify that under a single fault, hazardous voltages do not appear at the module's output.

Note: Do not ground either of the input pins of the module without grounding one of the output pins. This may allow a non-SELV/ES1 voltage to appear between the output pins and ground.

The power module has safety extra-low voltage (SELV) or ES1 outputs when all inputs are SELV or ES1.

The input to these units is to be provided with a maximum 30 A fast-acting (or time-delay) fuse in the ungrounded input lead.



## Technical Specifications (Continued)

### Feature Descriptions

#### Overcurrent Protection

To provide protection in a fault output overload condition, the module is equipped with internal current-limiting circuitry and can endure current limiting continuously. If the overcurrent condition causes the output voltage to fall greater than 4.0V from  $V_{o, set}$ , the module will shut down and remain latched off. The overcurrent latch is reset by either cycling the input power or by toggling the on/off pin for one second. If the output overload condition still exists when the module restarts, it will shut down again. This operation will continue indefinitely until the overcurrent condition is corrected.

A factory configured auto-restart option (with overcurrent and overvoltage auto-restart managed as a group) is also available. An auto-restart feature continually attempts to restore the operation until fault condition is cleared.

#### Remote On/Off

The module contains a standard on/off control circuit reference to the  $V_{IN(-)}$  terminal. Two factory configured remote on/off logic options are available. Positive logic remote on/off turns the module on during a logic-high voltage on the ON/OFF pin, and off during a logic low. Negative logic remote on/off turns the module off during a logic high, and on during a logic low. Negative logic, device code suffix "1," is the factory-preferred configuration. The On/Off circuit is powered from an internal bias supply, derived from the input voltage terminals. To turn the power module on and off, the user must supply a switch to control the voltage between the On/Off terminal and the  $V_{IN(-)}$  terminal ( $V_{on/off}$ ). The switch can be an open collector or equivalent (see Figure 14). A logic low is  $V_{on/off} = -0.3V$  to 0.8V. The typical  $I_{on/off}$  during a logic low ( $V_{in}=48V$ , On/Off Terminal=0.3V) is 147 $\mu A$ . The switch should maintain a logic-low voltage while sinking 310 $\mu A$ . During a logic high, the maximum  $V_{on/off}$  generated by the power module is 8.2V. The maximum allowable leakage current of the switch at  $V_{on/off} = 2.0V$  is 10 $\mu A$ . If using an external voltage source, the maximum voltage  $V_{on/off}$  on the pin is 14.5V with respect to the  $V_{IN(-)}$  terminal.

If not using the remote on/off feature, perform one of the following to turn the unit on:

For negative logic, short ON/OFF pin to  $V_{IN(-)}$ .

For positive logic: leave ON/OFF pin open.

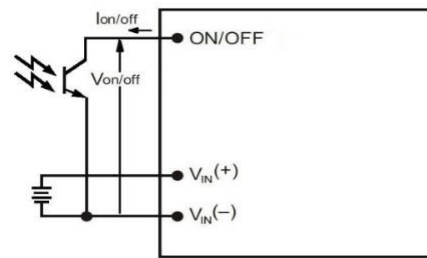

Figure 16. Remote On/Off Implementation.

#### Output Overvoltage Protection

The module contains circuitry to detect and respond to output overvoltage conditions. If the overvoltage condition causes the output voltage to rise above the limit in the Specifications Table, the module will shut down and remain latched off. The overvoltage latch is reset by either cycling the input power, or by toggling the on/off pin for one second. If the output overvoltage condition still exists when the module restarts, it will shut down again. This operation will continue indefinitely until the overvoltage condition is corrected.

A factory configured auto-restart option (with overcurrent and overvoltage auto-restart managed as a group) is also available. An auto-restart feature continually attempts to restore the operation until fault condition is cleared.

#### Overtemperature Protection

These modules feature an overtemperature protection circuit to safeguard against thermal damage. The circuit shuts down the module when the maximum device reference temperature is exceeded. The module will automatically restart once the reference temperature cools by  $\sim 25^{\circ}C$ .

#### Input Under/Over voltage Lockout

At input voltages above or below the input under/over voltage lockout limits, module operation is disabled. The module will begin to operate when the input voltage level changes to within the under and overvoltage lockout limits.

#### Load Sharing

For higher power requirements, the QBVW033A0 power module offers an optional feature for parallel operation (-P Option code). This feature provides a precise forced output voltage load regulation droop characteristic. The output set point and droop slope are factory calibrated to insure optimum matching of multiple modules' load regulation characteristics. To implement load sharing, the following requirements should be followed:

## Technical Specifications (continued)

### Feature Descriptions (continued)

- The  $V_{OUT}(+)$  and  $V_{OUT}(-)$  pins of all parallel modules must be connected together. Balance the trace resistance for each module's path to the output power planes, to insure best load sharing and operating temperature balance.
- $V_{IN}$  must remain between  $40V_{dc}$  and  $75V_{dc}$  for droop sharing to be functional.
- It is permissible to use a common Remote On/Off signal to start all modules in parallel.
- These modules contain means to block reverse current flow upon start-up, when output voltage is present from other parallel modules, thus eliminating the requirement for external output ORing devices. Modules with the -P option may automatically increase the Turn On delay,  $T_{delay}$ , as specified in the Feature Specifications Table, if output voltage is present on the output bus at startup.
- When parallel modules startup into a pre-biased output, e.g. partially discharged output capacitance, the  $T_{rise}$  is automatically increased, as specified in the Feature Specifications Table, to insure graceful startup.
- Insure that the total load is  $<50\% I_{O,MAX}$  (for a single module) until all parallel modules have started (load full start  $>$  module  $T_{delay}$  time max +  $T_{rise}$  time).
- If fault tolerance is desired in parallel applications, output ORing devices should be used to prevent a single module failure from collapsing the load bus.

### Remote Sense ("9" Option Code)

Remote sense minimizes the effects of distribution losses by regulating the voltage at the remote-sense connections (See Figure 15). The SENSE(-) pin should be always connected to  $V_{O}(-)$ . The voltage between the remote-sense pins and the output terminals must not exceed the output voltage sense range given in the Feature Specifications table:

$$[V_{O}(+) - V_{O}(-)] - [\text{SENSE}(+) ] \leq 0.5 \text{ V}$$

Although the output voltage can be increased by both the remote sense and by the trim, the maximum increase for the output voltage is not the sum of both. The maximum increase is the larger of either the remote sense or the trim.

The amount of power delivered by the module is defined as the voltage at the output terminals multiplied by the output current. When using remote sense and trim, the output voltage of the module can be increased, which at the same output current would increase the power output of the module. Care should be taken to ensure that the maximum output power of the module remains at or below the maximum rated power (Maximum rated power =  $V_{O,SET} \times I_{O,MAX}$ ).

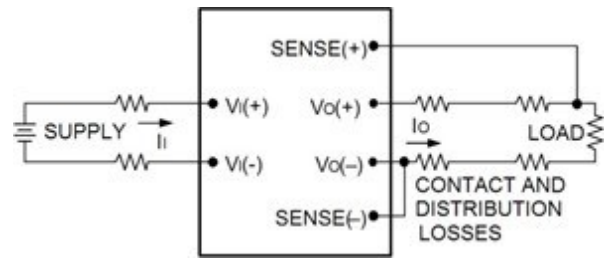

Figure 15. Circuit Configuration for remote sense.

### Trim, Output Voltage Adjust ("9" Option Code)

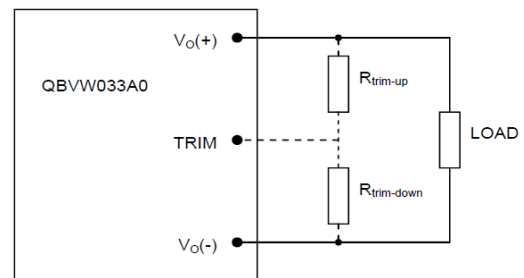

Figure 16. Circuit Configuration to Trim Output Voltage.

Trimming allows the output voltage set point to be increased or decreased; this is accomplished by connecting an external resistor between the TRIM pin and either the  $V_{O}(+)$  pin or the  $V_{O}(-)$  pin. Connecting an external resistor ( $R_{trim-down}$ ) between the TRIM pin and the  $V_{O}(-)$  (or Sense(-)) pin decreases the output voltage set point. To maintain set point accuracy, the trim resistor tolerance should be  $\pm 1.0\%$ .

The following equation determines the required external resistor value to obtain a percentage output voltage change of  $\Delta\%$ :

$$R_{trim-down} = \left[ \frac{511}{\Delta\%} - 10.22 \right] \text{ K}\Omega$$

$$\text{Where } \Delta\% = \left( \frac{V_{O,SET} - V_{desired}}{V_{O,SET}} \right) \times 100$$

For example, to trim-down the output voltage of the 12V nominal module by 20% to 9.6V,  $R_{trim-down}$  is calculated as follows:

$$\Delta\% = 20$$

$$R_{trim-down} = \left[ \frac{511}{\Delta\%} - 10.22 \right] \text{ K}\Omega$$

$$R_{trim-down} = 15.3\text{k}\Omega$$

## Technical Specifications (Continued)

### Feature Descriptions (continued)

Connecting an external resistor ( $R_{\text{trim-up}}$ ) between the TRIM pin and the  $V_o(+)$  (or Sense (+)) pin increases the output voltage set point. The following equations determine the required external resistor value to obtain a percentage output voltage change of  $\Delta\%$ :

$$R_{\text{trim-up}} = \left[ \frac{511 \times V_{o,\text{set}} \times (100 + \Delta\%)}{1.225 \times \Delta\%} - \frac{511}{\Delta\%} - 10.22 \right] \text{ K}\Omega$$

$$\text{Where } \Delta\% = \left( \frac{V_{\text{desired}} - V_{o,\text{set}}}{V_{o,\text{set}}} \right) \times 100$$

For example, to trim-up the output voltage of the 12V module by 5% to 12.6V,  $R_{\text{trim-up}}$  is calculated as follows:

$$R_{\text{trim-up}} = \left[ \frac{511 \times 12.0 \times (100 + 5)}{1.225 \times 5} - \frac{511}{5} - 10.22 \right] \text{ K}\Omega$$

$$R_{\text{trim-up}} = 938.8 \text{ K}\Omega$$

The voltage between the  $V_o(+)$  and  $V_o(-)$  terminals must not exceed the minimum output overvoltage protection value shown in the Feature Specifications table. This limit includes any increase in voltage due to remote-sense compensation and output voltage set-point adjustment trim.

Although the output voltage can be increased by both the remote sense and by the trim, the maximum increase for the output voltage is not the sum of both. The maximum increase is the larger of either the remote sense or the trim. The amount of power delivered by the module is defined as the voltage at the output terminals multiplied by the output current. When using remote sense and trim, the output voltage of the module can be increased, which at the same output current would increase the power output of the module. Care should be taken to ensure that the maximum output power of the module remains at or below the maximum rated power (Maximum rated power =  $V_{o,\text{set}} \times I_{o,\text{max}}$ ).

### Thermal Considerations

The thermal data presented here is based on physical measurements taken in a wind tunnel, using automated thermo-couple instrumentation to monitor key component temperatures: FETs, diodes, control ICs, magnetic cores, ceramic capacitors, optoisolators, and module pwb conductors, while controlling the ambient airflow rate and temperature.

For a given airflow and ambient temperature, the module output power is increased, until one (or more) of the components reaches its maximum derated operating temperature, as defined in IPC-9592B. This procedure is then repeated for a different airflow or ambient temperature until a family of module output derating curves is obtained.

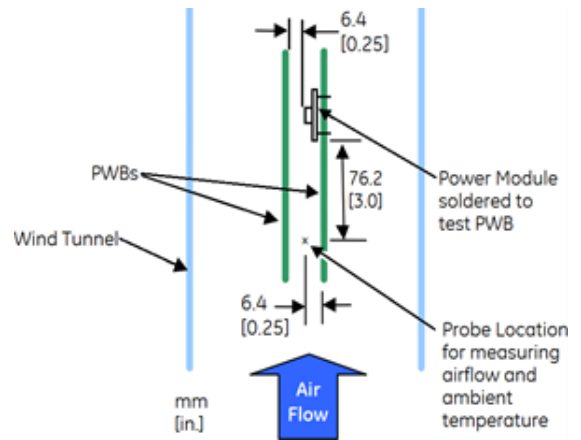

The power modules operate in a variety of thermal environments and sufficient cooling should be provided to help ensure reliable operation. Thermal considerations include ambient temperature, airflow, module power dissipation, and the need for increased reliability. A reduction in the operating temperature of the module will result in an increase in reliability.

Heat-dissipating components are mounted on the top side of the module. Heat is removed by conduction, convection and radiation to the surrounding environment. Proper cooling can be verified by measuring the thermal reference temperature ( $TH_1$  or  $TH_2$ ). Peak temperature occurs at the position indicated in Figure 17 and 18. For reliable operation this temperature should not exceed  $TH_1=125^\circ\text{C}$  or  $TH_2=105^\circ\text{C}$ . For extremely high reliability you can limit this temperature to a lower value.

## Technical Specifications (continued)

### Thermal Considerations (continued)

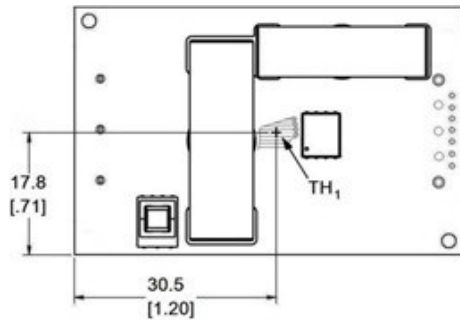

**Figure 17. Location of the thermal reference temperature TH<sub>1</sub> for open frame module.**

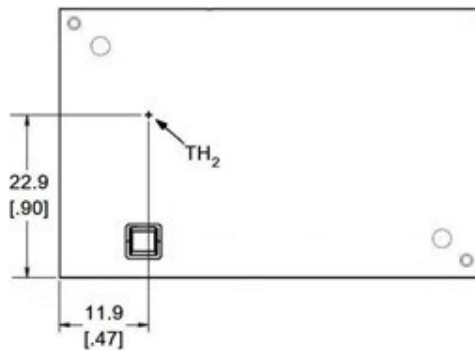

**Figure 18. Location of the thermal reference temperature TH<sub>2</sub> for base plate module.**

The output power of the module should not exceed the rated power for the module as listed in the Ordering Information table.

Please refer to the Application Note “Thermal Characterization Process For Open-Frame Board-Mounted Power Modules” for a detailed discussion of thermal aspects including maximum device temperatures.

#### Heat Transfer via Convection

Increased airflow over the module enhances the heat transfer via convection. The thermal derating of figure 19- 23 shows the maximum output current that can be delivered by each module in the indicated orientation without exceeding the maximum TH<sub>x</sub> temperature versus local ambient temperature (T<sub>A</sub>) for several air flow conditions.

The use of Figure 19 is shown in the following example:

#### Example

What is the minimum airflow necessary for a QBVW033A0B operating at V<sub>I</sub> = 48 V, an output current of 20A, and a maximum ambient temperature of 60 °C in transverse orientation.

Solution:

Given: V<sub>in</sub> = 48V, I<sub>o</sub> = 20A, T<sub>A</sub> = 60°C Determine required airflow velocity (Use Figure 19):

Velocity = 0.5m/s (100 LFM) or greater.

# Technical Specifications (continued)

## Thermal Considerations (continued)

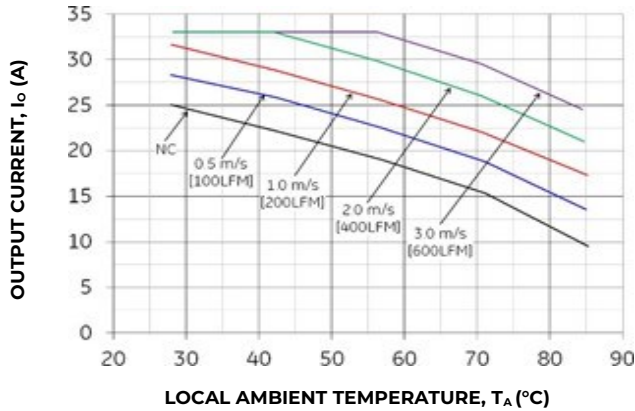

Figure 19. Output Current Derating for the Open Frame QBVW033A0B in the Transverse Orientation; Airflow Direction from  $V_{in(-)}$  to  $V_{in(+)}$ ;  $V_{in} = 48V$ .

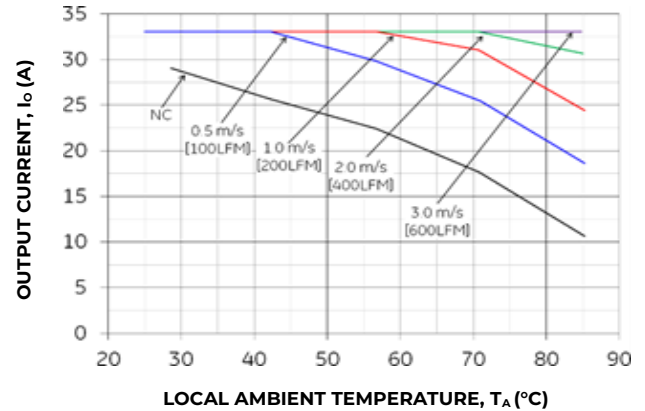

Figure 22. Output Current Derating for the Base plate QBVW033A0B-H with 0.5" heatsink in the Transverse Orientation; Airflow Direction from  $V_{in(-)}$  to  $V_{in(+)}$ ;  $V_{in} = 48V$

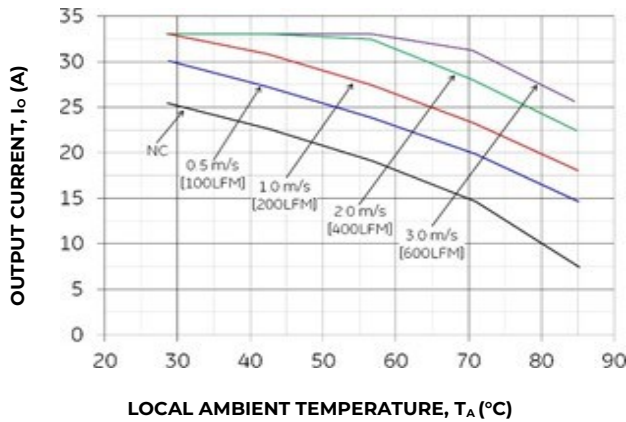

Figure 20. Output Current Derating for the Base plate QBVW033A0B-H in the Transverse Orientation; Airflow Direction from  $V_{in(-)}$  to  $V_{in(+)}$ ;  $V_{in} = 48V$ .

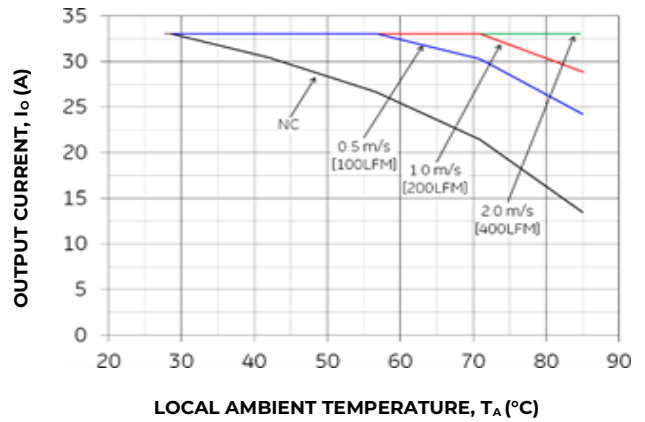

Figure 23. Output Current Derating for the Base plate QBVW033A0B-H with 1.0" heatsink in the Transverse Orientation; Airflow Direction from  $V_{in(-)}$  to  $V_{in(+)}$ ;  $V_{in} = 48V$ .

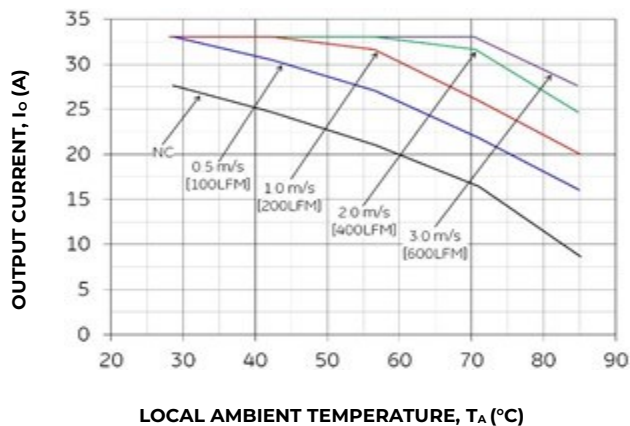

Figure 21. Output Current Derating for the Base plate QBVW033A0B-H with 0.25" heatsink in the Transverse Orientation; Airflow Direction from  $V_{in(-)}$  to  $V_{in(+)}$ ;  $V_{in} = 48V$

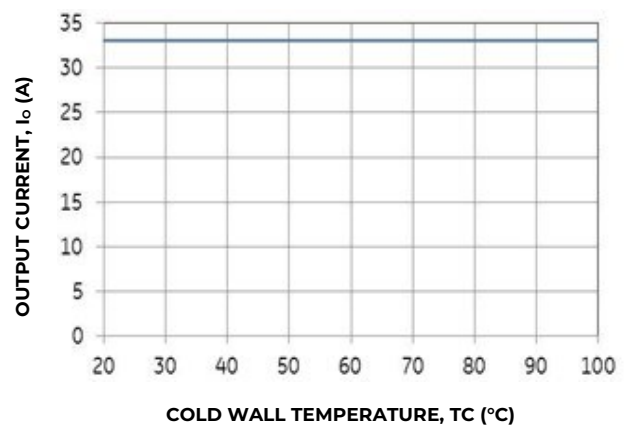

Figure 24. Output Current Derating for the Base Plate QBVW033A0B-H in a Cold wall application; Local Internal Air Temperature near module=80°C,  $V_{in} = 48V$ ,  $V_{out}$  setting anywhere from 6.0V to 12.0V.



## Technical Specifications (continued)

### Layout Considerations

The QBVW033 power module series are low profile in order to be used in fine pitch system card architectures. As such, component clearance between the bottom of the power module and the mounting board is limited. Avoid placing copper areas on the outer layer directly underneath the power module. Also avoid placing via interconnects underneath the power module.

For additional layout guide-lines, refer to FLTR100V10 Data Sheet.

### Through-Hole Lead-Free Soldering Information

The RoHS-compliant, Z version, through-hole products use the SAC (Sn/Ag/Cu) Pb-free solder and RoHS-compliant components. The module is designed to be processed through single or dual wave soldering machines. The pins have a RoHS-compliant, pure tin finish that is compatible with both Pb and Pb-free wave soldering processes. A maximum preheat rate of 3°C/s is suggested. The wave preheat process should be such that the temperature of the power module board is kept below 210°C. For Pb solder, the recommended pot temperature is 260°C, while the Pb-free solder pot is 270°C max.

### Reflow Lead-Free Soldering Information

The RoHS-compliant through-hole products can be processed with the following paste-through-hole Pb or Pb-free reflow process.

Max. sustain temperature :

245°C (J-STD-020C Table 4-2: Packaging

Thickness $\geq$ 2.5mm /

Volume > 2000mm<sup>3</sup>),

Peak temperature over 245°C is not suggested due to the potential reliability risk of components under continuous high temperature.

Min. sustain duration above 217°C : 90 seconds

Min. sustain duration above 180°C : 150 seconds

Max. heat up rate: 3°C/sec

Max. cool down rate: 4°C/sec

In compliance with JEDEC J-STD-020C spec for 2 times reflow requirement.

### Pb-free Reflow Profile

BMP module will comply with J-STD-020 Rev. C (Moisture/Reflow Sensitivity Classification for Nonhermetic Solid State Surface Mount Devices) for both Pb-free solder profiles and MSL classification procedures. BMP will comply with JEDEC J-STD-020C specification for 3 times reflow requirement. The suggested Pb-free solder paste is Sn/Ag/Cu (SAC). The recommended linear reflow profile using Sn/Ag/Cu solder is shown in Figure 24.

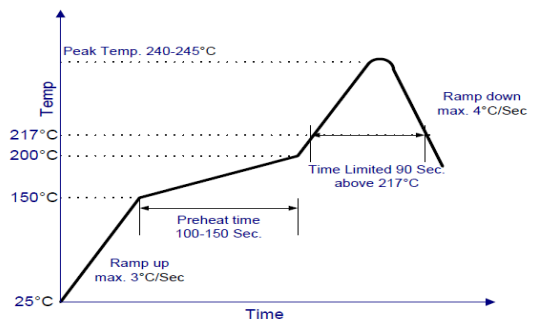

Figure 25. Recommended linear reflow profile using Sn/Ag/Cu solder.

### MSL Rating

The QBVW033A0B modules have a MSL rating as indicated in the Device Codes table, last page of this document.

### Storage and Handling

The recommended storage environment and handling procedures for moisture-sensitive surface mount packages is detailed in J-STD-033 Rev. A (Handling, Packing, Shipping and Use of Moisture/Reflow Sensitive Surface Mount Devices). Moisture barrier bags (MBB) with desiccant are required for MSL ratings of 2 or greater. These sealed packages should not be broken until time of use. Once the original package is broken, the floor life of the product at conditions of  $\leq$ 30°C and 60% relative humidity varies according to the MSL rating (see J-STD-033A). The shelf life for dry packed SMT packages will be a minimum of 12 months from the bag seal date, when stored at the following conditions: < 40° C, < 90% relative humidity.



## Technical Specifications (continued)

### Post Solder Cleaning and Drying Considerations

Post solder cleaning is usually the final circuit-board assembly process prior to electrical board testing. The result of inadequate cleaning and drying can affect both the reliability of a power module and the testability of the finished circuit-board assembly. For guidance on appropriate soldering, cleaning and drying procedures, refer to OmniOn Board Mounted Power Modules: Soldering and Cleaning Application Note (AN04-001).

If additional information is needed, please consult with your OmniOn representative for more details.

## Technical Specifications (continued)

### EMC Considerations

The circuit and plots in Figure 25 shows a suggested configuration to meet the conducted emission limits of EN55032 Class A. For further information on designing for EMC compliance, please refer to the FLT012A0Z data sheet.

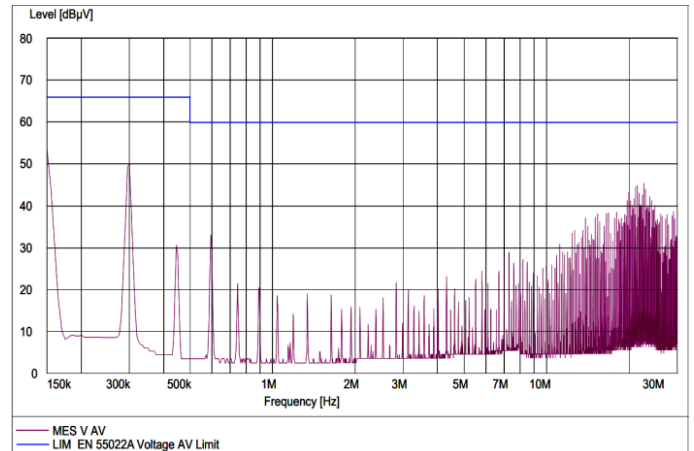
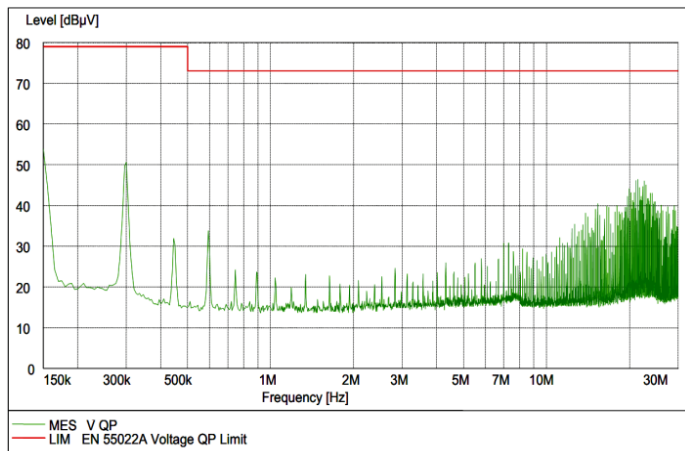
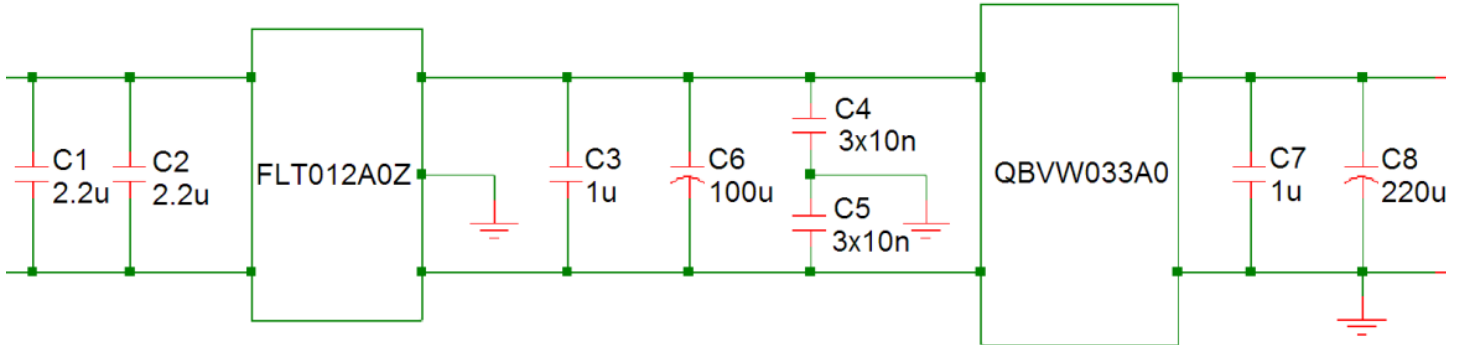

Figure 26. EMC Considerations

# Technical Specifications (continued)

## Mechanical Outline for QBVW033A0B Through-hole Module

Dimensions are in millimeters and [inches].

Tolerances: x.x mm ± 0.5 mm [x.xx in. ± 0.02 in.] (Unless otherwise indicated)

x.xx mm ± 0.25 mm [x.xxx in ± 0.010 in.]

\*Top side label includes OmniOn name, product designation, and data code.

\*\* Standard pin tail length. Optional pin tail lengths shown in Table 2, Device Options.

TOP VIEW\*

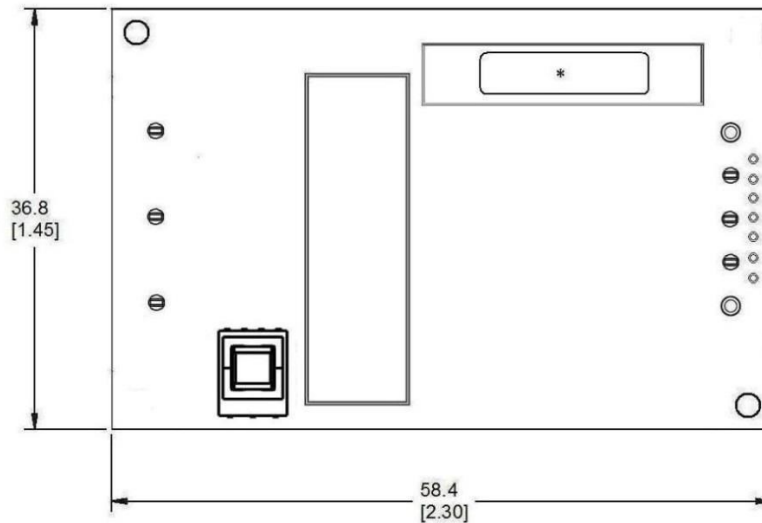

SIDE VIEWS

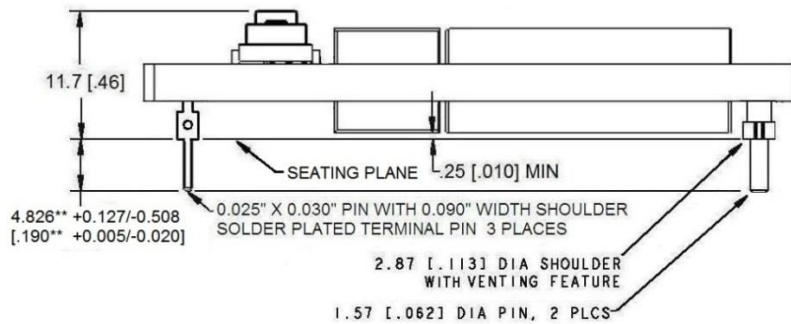

BOTTOM VIEW

Pin Number	Pin Name
1	V <sub>IN</sub> (+)
2	ON/OFF
3	V <sub>IN</sub> (-)
4	V <sub>OUT</sub> (-)
5†	SENSE(-)
6†	TRIM
7†	SENSE(+)
8	V <sub>OUT</sub> (+)

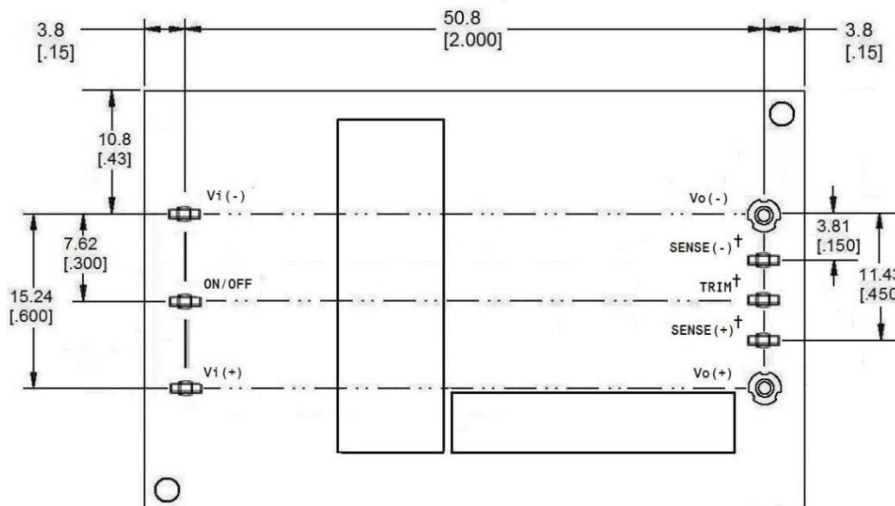

† - Optional Pins See Table 2

# Technical Specifications (continued)

## Mechanical Outline for QBVW033A0B-H (Base plate) Through-hole Module

Dimensions are in millimeters and (inches).

Tolerances: x.x mm ± 0.5 mm [x.xx in. ± 0.02 in.] (unless otherwise indicated)

x.xx mm ± 0.25 mm [x.xxx in ± 0.010 in.]

\*Side label includes product designation, and data code.

\*\* Standard pin tail length. Optional pin tail lengths shown in Table 2, Device Options.

\*\*\*Bottom label includes OmniOn name, product designation, and data code

TOP VIEW

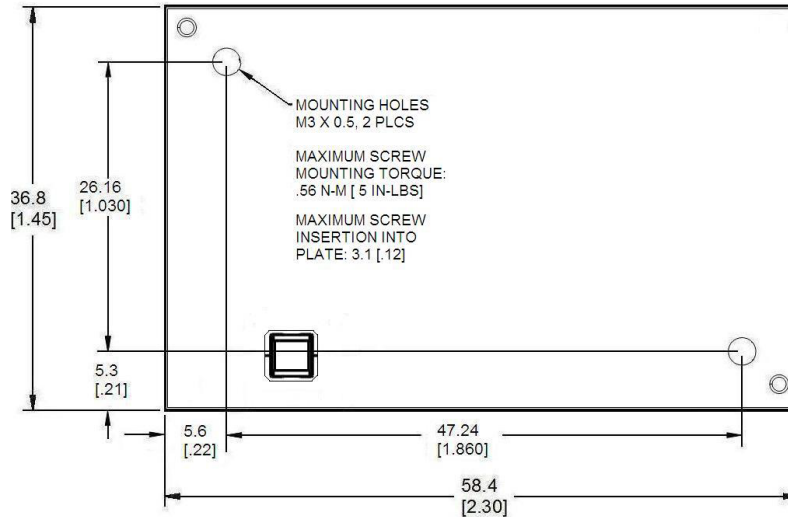

SIDE VIEWS\*

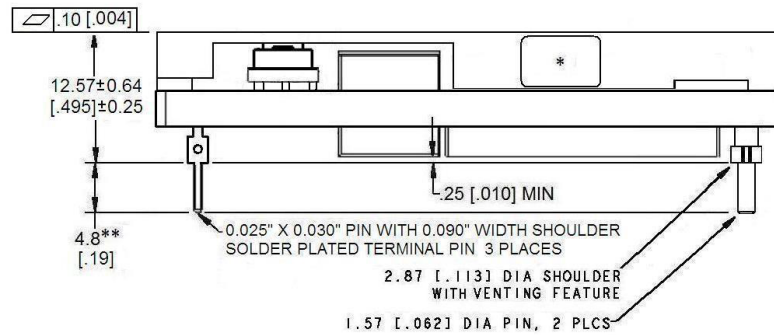

BOTTOM VIEW\*\*\*

Pin Number	Pin Name
1	V <sub>IN</sub> (+)
2	ON/OFF
3	V <sub>IN</sub> (-)
4	V <sub>OUT</sub> (-)
5†	SENSE(-)
6†	TRIM
7†	SENSE(+)
8	V <sub>OUT</sub> (+)

† - Optional Pins See Table 2

Page 18

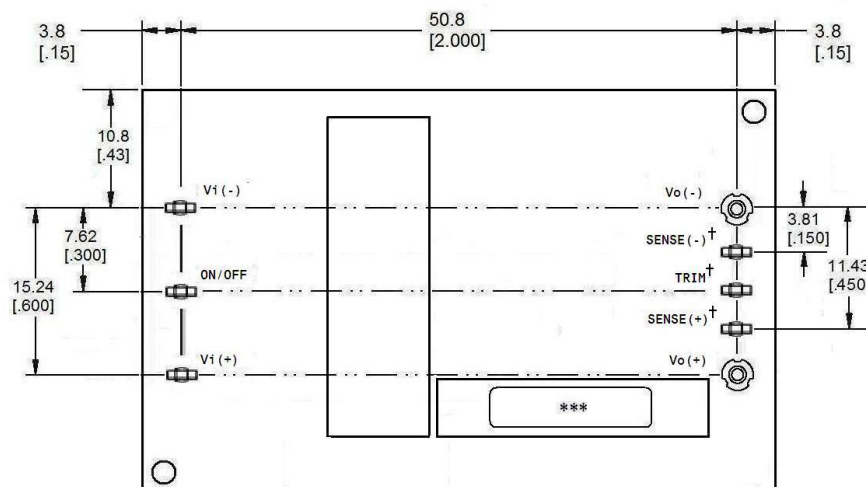

## Technical Specifications (continued)

### Recommended Pad Layouts

Dimensions are in millimeters and (inches).

Tolerances: x.x mm ± 0.5 mm [x.xx in. ± 0.02 in.] (unless otherwise indicated)

x.xx mm ± 0.25 mm [x.xxx in ± 0.010 in.]

### Through-Hole Modules

Pin Number	Pin Name
1	V <sub>IN</sub> (+)
2	ON/OFF
3	V <sub>IN</sub> (-)
4	V <sub>OUT</sub> (-)
5†	SENSE(-)
6†	TRIM
7†	SENSE(+)
8	V <sub>OUT</sub> (+)

† - Optional Pins See Table 2

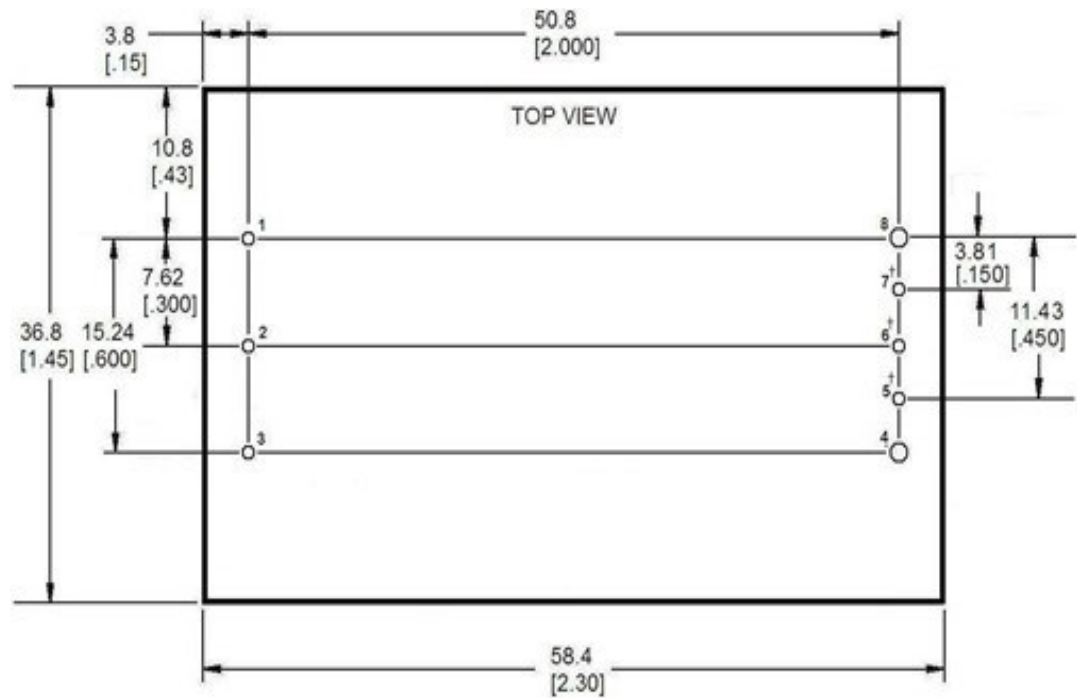

Hole and Pad diameter recommendations:

Pin Number	Hole Dia mm [in]	Pad Dia mm [in]
1, 2, 3, 5, 6, 7	1.6 [.063]	2.1 [.083]
4, 8	2.2 [.087]	3.2 [.126]

# Technical Specifications (continued)

## Packaging Details

All versions of the QBVEW033A0B are supplied as standard in the plastic trays shown in Figure 27.

### Tray Specification

Material	PET (1mm)
Max surface resistivity	$10^9 - 10^{11} \Omega/\text{PET}$
Color	Clear
Capacity	12 power modules
Min order quantity	24 pcs (1 box of 2 full trays + 1 empty top tray)

Each tray contains a total of 12 power modules. The trays are self-stacking and each shipping box for the QBVEW033A0B module contains 2 full trays plus one empty hold-down tray giving a total number of 24 power modules.

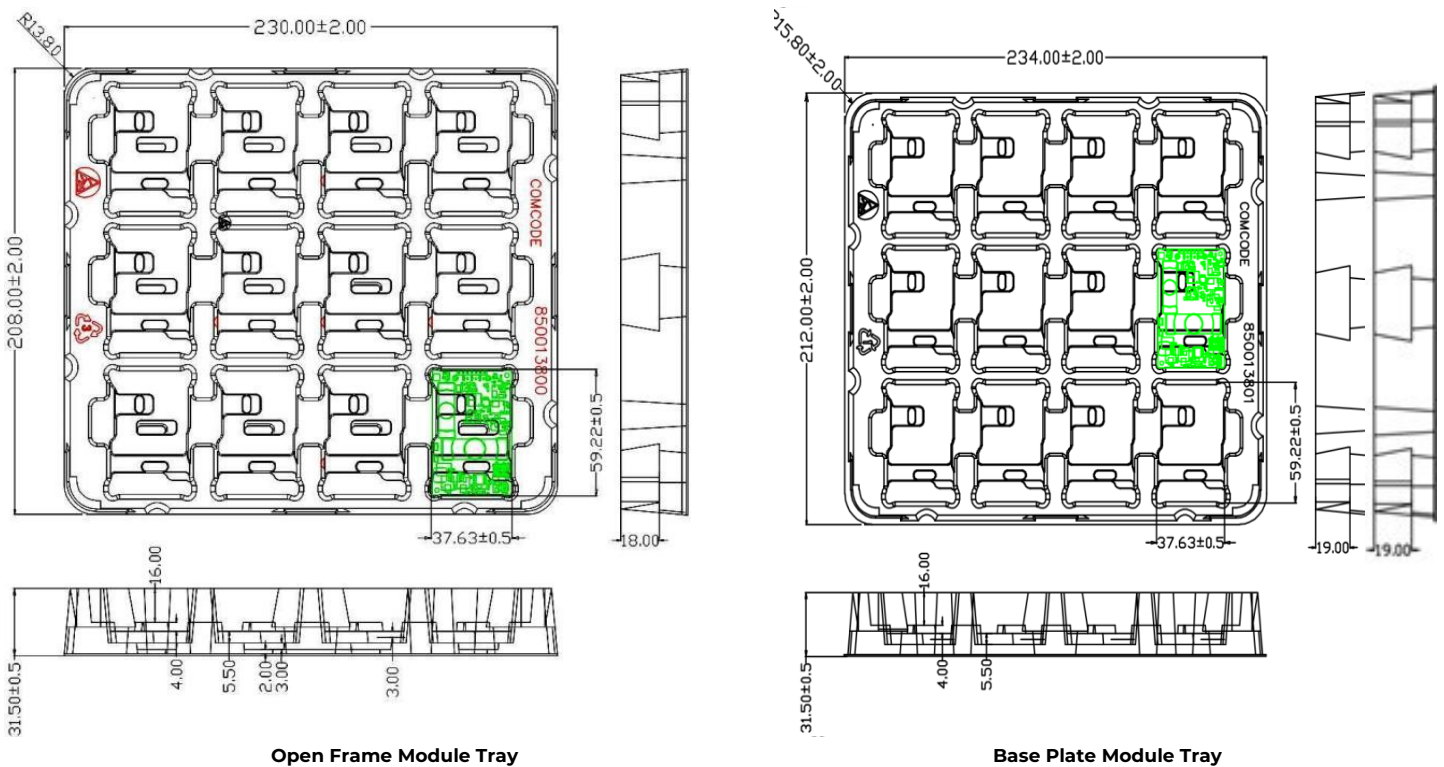

Figure 27. QBVEW033A0B Packaging Tray



## Technical Specifications (continued)

### Ordering Information

Please contact your OmniOn Sales Representative for pricing, availability and optional features.

Product codes	Input Voltage	Output Voltage	Output Current	Efficiency	Connector Type	MSI Rating	Ordering Codes
QBVW033A0B41Z	48V (36-75V <sub>dc</sub> )	12V	33A	95.5%	Through hole	2a	CC109165247
QBVW033A0B64Z	48V (36-75V <sub>dc</sub> )	12V	33A	95.5%	Through hole	2a	150023767
QBVW033A0B541Z	48V (36-75V <sub>dc</sub> )	12V	33A	95.5%	Through hole	2a	CC109165263
QBVW033A0B641Z	48V (36-75V <sub>dc</sub> )	12V	33A	95.5%	Through hole	2a	CC109165692
QBVW033A0B841Z	48V (36-75V <sub>dc</sub> )	12V	33A	95.5%	Through hole	2a	CC109169347
QBVW033A0B1-HZ	48V (36-75V <sub>dc</sub> )	12V	33A	95.5%	Through hole	2a	CC109168126
QBVW033A0B41-HZ	48V (36-75V <sub>dc</sub> )	12V	33A	95.5%	Through hole	2a	CC109165255
QBVW033A0B61-HZ	48V (36-75V <sub>dc</sub> )	12V	33A	95.5%	Through hole	2a	CC109167813
QBVW033A0B64-HZ	48V (36-75V <sub>dc</sub> )	12V	33A	95.5%	Through hole	2a	150023766
QBVW033A0B641-HZ	48V (36-75V <sub>dc</sub> )	12V	33A	95.5%	Through hole	2a	CC109165701
QBVW033A0B841-HZ	48V (36-75V <sub>dc</sub> )	12V	33A	95.5%	Through hole	2a	150027041
QBVW033A0B941-HZ	48V (36-75V <sub>dc</sub> )	12V	33A	95.5%	Through hole	2a	CC109170627
QBVW033A0B964-HZ	48V (36-75V <sub>dc</sub> )	12V	33A	95.5%	Through hole	2a	150026356
QBVW033A0B9641-HZ	48V (36-75V <sub>dc</sub> )	12V	33A	95.5%	Through hole	2a	150019350
QBVW033A0B41-PZ	48V (36-75V <sub>dc</sub> )	12V	33A	95.5%	Through hole	2a	CC109169314
QBVW033A0B541-PZ	48V (36-75V <sub>dc</sub> )	12V	33A	95.5%	Through hole	2a	CC109167086
QBVW033A0B841-PZ	48V (36-75V <sub>dc</sub> )	12V	33A	95.5%	Through hole	2a	CC109169355
QBVW033A0B1-PHZ	48V (36-75V <sub>dc</sub> )	12V	33A	95.5%	Through hole	2a	CC109167094
QBVW033A0B41-PHZ	48V (36-75V <sub>dc</sub> )	12V	33A	95.5%	Through hole	2a	CC109167103
QBVW033A0B61-PHZ	48V (36-75V <sub>dc</sub> )	12V	33A	95.5%	Through hole	2a	CC109167111
QBVW033A0B641-PHZ	48V (36-75V <sub>dc</sub> )	12V	33A	95.5%	Through hole	2a	CC109167540
QBVW033A0B41-DHZ <sup>1</sup>	48V (36-75V <sub>dc</sub> )	12V	33A	95.5%	Through hole	2a	1600282152A

Table 1. Device Codes.

<sup>1</sup> Polyurethane Conformal coating on both sides is included for the -D option. The -D version is not compatible with paste-in-hole reflow soldering. Contact your OmniOn sales representative for more information.

	Characteristic	Character and Position										Definition	
Ratings	Form Factor	Q											Q = Quarter Brick
	Family Designator	B	V										BV = BARRACUDA™ Series, without PMBus interface
	Input Voltage		W										E = Wide Range 36V-75V
	Output Current			033A	0								033A0 = 033.0 Amps Maximum Output Current
	Output Voltage				B								B = 12.0V nominal
	Trim and Remote Sense Pins					9							Omit = Exclude Trim & Sense Pins 9 = Include Trim and Sense Pins
Options	Pin Length						8	6	5				Omit = Default Pin Length shown in Mechanical Outline Figures 8 = Pin Length: 2.79 mm ± 0.25mm, (0.110 in. ± 0.010 in.) 6 = Pin Length: 3.68 mm ± 0.25mm, (0.145 in. ± 0.010 in.) 5 = Pin Length: 6.35 mm ± 0.25mm, (0.250 in. ± 0.010 in.)
	Action following Protective Shutdown							4					Omit = Latching Mode 4 = Auto-restart following shutdown (Overcurrent/Overvoltage)
	On/Off Logic								1				Omit = Positive Logic 1 = Negative Logic
	Customer Specific										XY		XY = Customer Specific Modified Code, Omit for Standard Code
	Optional Features											P	Omit = Standard open Frame Module P = Forced Droop Output for use in parallel applications D = Polyurethane Conformal coating on both sides. Not compatible with paste-in-hole reflow soldering.
	RoHS												H
													Omit = RoHS5/6, Lead Based Solder Used Z = RoHS Compliant

Table 2. Device Options.

## Change History (excludes grammar & clarifications)

Revision	Date	Description of the change
1.8	06-16-2022	Updated as per template, ROHS
1.9	04-16-2023	Added New Ordering Code
1.10	11-08-2023	Updated as per OmniOn template

**OmniOn Power Inc.**

601 Shiloh Rd.  
Plano, TX USA

[omnionpower.com](http://omnionpower.com)

We reserve the right to make technical changes or modify the contents of this document without prior notice. OmniOn Power does not accept any responsibility for errors or lack of information in this document and makes no warranty with respect to and assumes no liability as a result of any use of information in this document.

Page 23

© 2023 OmniOn Power Inc. All rights reserved.

We reserve all rights in this document and in the subject matter and illustrations contained therein. Any reproduction, disclosure to third parties or utilization of its contents – in whole or in parts – is forbidden without prior written consent of OmniOn Power. This document does not convey license to any patent or any intellectual property right. Copyright© 2023 OmniOn Power Inc. All rights reserved.

QBVW033A0B\_DS

Rev. 1.10

# Mouser Electronics

Authorized Distributor

Click to View Pricing, Inventory, Delivery & Lifecycle Information:

[OmniOn Power:](#)

[QBVW033A0B41-HZ](#) [QBVW033A0B41Z](#) [QBVW033A0B1-HZ](#) [QBVW033A0B41-IHZ](#) [QBVW033A0B41-PZ](#)  
[QBVW033A0B61-HZ](#) [QBVW033A0B641-PHZ](#) [QBVW033A0B841-PZ](#) [QBVW033A0B841Z](#) [QBVW033A0B941-HZ](#)  
[QBVW033A0B641Z](#) [QBVW033A0B641-HZ](#) [QBVW033A0B1-PHZ](#) [QBVW033A0B41-PHZ](#) [QBVW033A0B61-PHZ](#)  
[QBVW033A0B9641-HZ](#) [QBVW033A0B964-HZ](#) [QBVW033A0B941Z](#)