

# IND033 Hornet: Non-Isolated DC-DC Voltage Regulator Modules

12Vdc input; 0.8Vdc to 5.5Vdc output; 33W Max Power



### Applications

- ✓ Industrial Equipment
- ✓ Control Boards
- ✓ Test Equipment

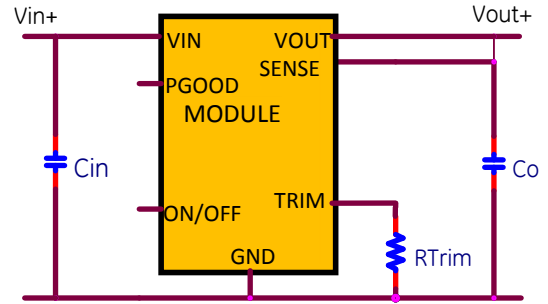

### Electrical Features

- 12V Input voltage with up to  $\pm 20\%$  Tolerance
- Output voltage programmable from 0.8Vdc to 5.5Vdc via external resistor
- Remote On/Off for optional external control
- Power Good signal for external monitoring
- Fixed switching frequency
- Output overcurrent protection (non-latching)

### Mechanical Features

- Small size: 12.2 mm x 12.2 mm x 7.25 mm (0.48 in x 0.48 in x 0.29 in)
- Operating range:  $-40^{\circ}\text{C}$  to  $105^{\circ}\text{C}$  ambient
- Operating shock to 40G per Mil Std. 810G, Method 516.4 Procedure I
- Operating vibration per Mil Std. 810G, Method 514.5 Procedure I

### Process and Safety

- Qualified for 1000h High Temperature Operating Bias, 1000h 85RH/85°C Temperature, Humidity and Bias, 700 cycle  $-40$  to  $125^{\circ}\text{C}$  thermal cycling
- ANSI/UL# 60950-1 2<sup>nd</sup> Revised October 14, 2014, CSA† C22.2 No. 60950-1-07, Second Ed. + A2:2014 (MOD) Recognized, DIN EN 60950-1:2006 + A11:2009 + A1:2010 + A12:2011, + A2:2013 (VDE† 0805-1) Licensed
- ISO\*\* 9001 and ISO 14001 certified manufacturing facilities
- Compliant to RoHS II EU "Directive 2011/65/EU"
- Compatible in a Pb-free or SnPb reflow environment.
- Suitable for aqueous clean.
- Suitable for conformal coating with dip and vapor deposition. Conformal coating can provide the protection to meet Salt Fog Test per IEC 60068-2-52 (Severity 3) and Mixed Gas Flow test per Telcordia GR-3108 Outdoor Levels.
- 3 year warranty

Device Code	Input Voltage	Output Voltage	Output Current (Max.)	On/Off Logic	Comcode
IND033	9.6 - 14.4**Vdc	0.8 - 5.5Vdc	6A	Negative	1600102898A

### Thermal Performance

Full rated output with natural convection up to  $100^{\circ}\text{C}$  at 1.2Vout and up to  $90^{\circ}\text{C}$  at 5Vout. Thermal curves for 1.2V, 1.8V and 5Vout below.

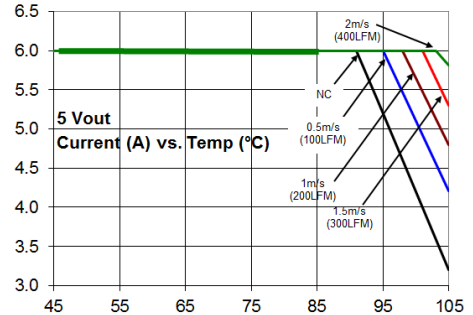
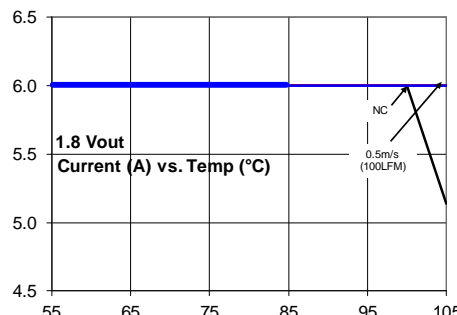
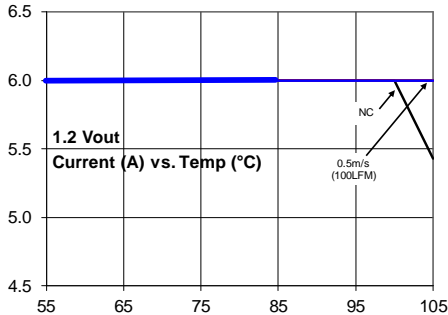

**Electrical Specifications**

Parameter	Device	Symbol	Min	Typ	Max	Unit
Operating Input Voltage	All	$V_{IN}$	9.6	12	14.4**	Vdc
Input No Load Current ( $V_{IN} = 12.0Vdc, I_O = 0$ , module enabled)	$V_{O, set} = 5Vdc$	$I_{IN, No load}$		55		mA
External Capacitance, Ceramic ESR $\geq 1 m\Omega$	All	$C_{O, max}$	10	—	22*	$\mu F$
Efficiency 12V <sub>INDC</sub> , T <sub>A</sub> =25°C, I=12A, V <sub>o</sub> =1.2 to 5Vdc		$\eta$	86(1.2V), 89(1.8V), 93(3.3V), 94(5V)			%
Switching Frequency	All	$f_{sw}$	—	600	—	kHz
Output Voltage (Over all line, load, and temperature conditions until end of life)	All	$V_O, set$	-3.0	—	+3.0	% $V_O, set$
On/Off Logic High (MODULE OFF) Input High Voltage	All	$V_{IH}$	3.0	—	14.4	Vdc
On/ Off Logic Low (MODULE ON) Input Low Voltage	All	$V_{IL}$	-0.2	—	0.4	Vdc
PGOOD (Power Good) Signal Interface Open Drain, $V_{supply} \leq 5VDC$						
Overvoltage threshold for PGOOD				112.5		% $V_{O, set}$
Undervoltage threshold for PGOOD				87.5		% $V_{O, set}$
Pulldown resistance of PGOOD pin	All			30		$\Omega$
Sink current capability into PGOOD pin	All				5	mA

\*Additional External Capacitance possible using Tunable Loop

\*\* For  $0.8 \leq V_{out} < 1$ , do not exceed 12Vin. For  $1 \leq V_{out} < 1.2$ , do not exceed 13Vin. For  $V_{out} \geq 1.2$ , Input Voltage can be as high as 14.4V

**Characteristic Curves**

The following figures provide typical characteristics for the IND033 Hornet at 25°C.

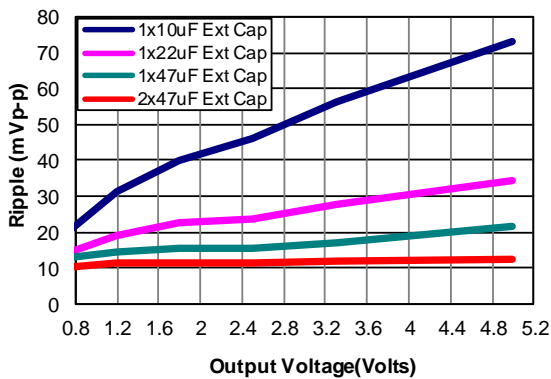

Figure 1. Output Ripple Voltage (20MHz BW) for various output voltages and external caps @12Vin. Additional Decoupling cap of 0.1uF used on input and output side

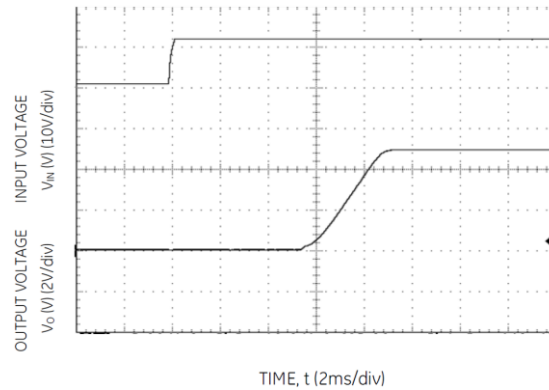

Figure 2. Typical Start-up using Input Voltage ( $V_{in}=12V, V_{out} = V_{out, max}, I_{out} = I_{out, max}$ )

**Trim**

Without an external resistor between Trim and GND pins, the output of the module will be 0.6Vdc.  $R_{trim}$  for a desired output voltage, should be as per the following table. The formula in the last column helps determine  $R_{trim}$  for other voltages.

$V_o$ (V)	0.9	1.2	1.5	1.8	2.5	3.3	5.0	$R_{trim} = \left[ \frac{12}{(V_o - 0.6)} \right] k\Omega$
$R_{trim}$ (k $\Omega$ )	40	20	13.3	10	6.316	4.4	2.727	

**Safety Considerations**

For safety agency approval, the power module must be installed in compliance with the spacing and separation requirements of the end-use safety agency standards listed on the first page of this document. For the converter output to be considered meeting the requirements of safety extra-low voltage (SELV), the input must meet SELV requirements. The power module has extra-low voltage (ELV) outputs when all inputs are ELV. The input to these units is to be provided with a fast-acting fuse with a maximum rating of 10A, 125VDC in the positive input lead.

**Tunable Loop**

The module is designed for 1x22uF capacitor on its output. For applications where more than 1x22uF capacitors would be used on the output, an additional Resistor (R<sub>tune</sub>) and Capacitor (C<sub>tune</sub>) would be required in the circuit schematic to compensate for the additional capacitance. The placement is between the Sense+ pin and Trim pin as per figure below:

The recommended values for R<sub>tune</sub> and C<sub>tune</sub> for different amounts of external capacitance are as per the table below:

Co	1x47μF	2x47μF	4x47μF	6x47μF	10x47μF
R <sub>TUNE</sub>	330	270	220	180	180
C <sub>TUNE</sub>	680pF	1800pF	3300pF	4700pF	5600pF

Figure. 3. Circuit diagram showing connection of R<sub>TUNE</sub> and C<sub>TUNE</sub> to tune the control loop of the module

**PowerGood (PGOOD)**

This is an open-drain output to indicate that the output voltage is within the regulation limits of the module. The PGOOD signal will be de-asserted to a low state if any condition such as overtemperature, overcurrent or loss of regulation occurs that would result in the output voltage going ±10% outside the setpoint value. If not used, leave unconnected.

**Recommended Pad Layout**

Dimensions are in millimeters and (inches).

Tolerances: x.x mm ± 0.5 mm (x.xx in. ± 0.02 in.) [unless otherwise indicated] x.xx mm ± 0.25 mm (x.xxx in ± 0.010 in.)

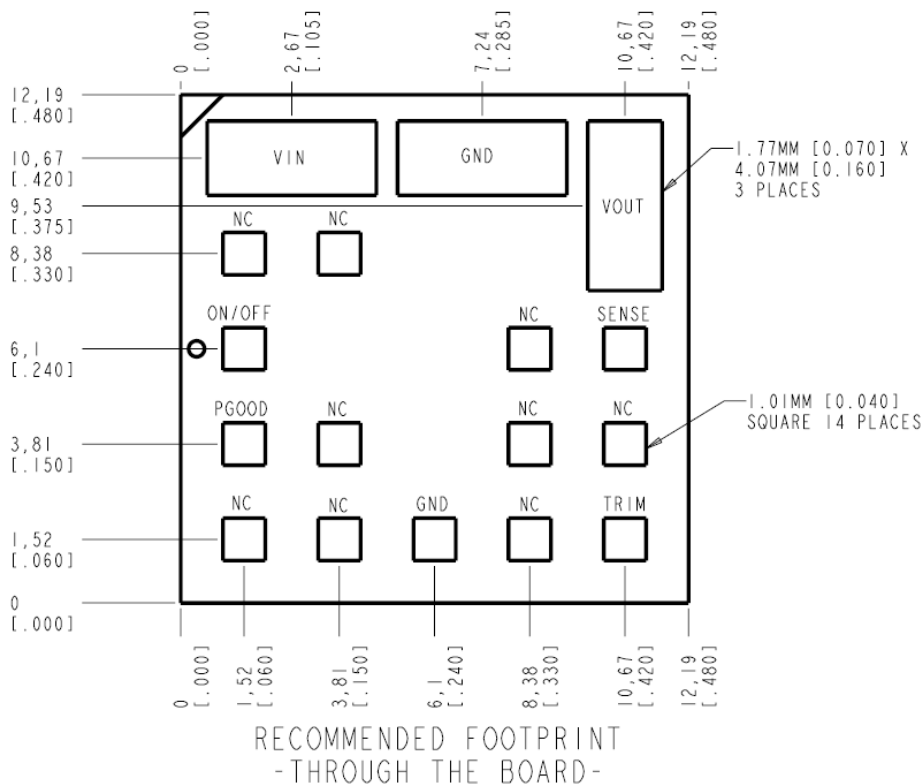

## Nozzle Recommendations

The minimum recommended inside nozzle diameter for reliable operation is 3mm. The maximum nozzle outer diameter, which will safely fit within the allowable component spacing, is 7 mm.

## Bottom Side / First Side Assembly

This module is not recommended for assembly on the bottom side of a customer board. If such an assembly is attempted, components may fall off the module during the second reflow process

## Lead Free Soldering

The modules are lead-free (Pb-free) and RoHS compliant and fully compatible in a Pb-free soldering process. Failure to observe the instructions below may result in the failure of or cause damage to the modules and can adversely affect long-term reliability

## MSL Rating

The modules have a MSL rating of 2a.

## Pb-free Reflow Profile

Power Systems will comply with J-STD-020 Rev. D (Moisture/Reflow Sensitivity Classification for Nonhermetic Solid State Surface Mount Devices) for both Pb-free solder profiles and MSL classification procedures. The suggested Pb-free solder paste is Sn/Ag/Cu (SAC).

The following profile is the recommended linear reflow profile using Sn/Ag/Cu solder. Soldering outside of the recommended profile requires testing to verify results and performance.

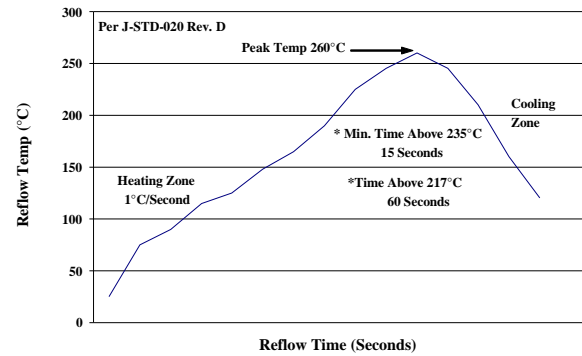

## Storage and Handling

J-STD-033 Rev. A (Handling, Packing, Shipping and Use of Moisture/Reflow Sensitive Surface Mount Devices) is recommended. Moisture barrier bags (MBB) with desiccant are required for MSL ratings of 2 or greater. These sealed packages should not be broken until time of use. Once the original package is broken, the floor life of the product at conditions of  $\leq 30^{\circ}\text{C}$  and 60% relative humidity varies according to the MSL rating (see J-STD-033A). The shelf life for dry packed SMT packages will be a minimum of 12 months from the bag seal date, when stored at the following conditions:  $< 40^{\circ}\text{C}$ ,  $< 90\%$  relative humidity.

## Post Solder Cleaning and Drying Considerations

Post solder cleaning is usually the final circuit-board assembly process prior to electrical board testing. The result of inadequate cleaning and drying can affect both the reliability of a power module and the testability of the finished circuit-board assembly

## Contact Us

For more information, call us at

USA/Canada:

**+1 888 546 3243**, or +1 972 244 9288

Asia-Pacific:

+86.021.54279977\*808

Europe, Middle-East and Africa:

+49.89.878067-280

[www.gecriticalpower.com](http://www.gecriticalpower.com)



GE Critical Power reserves the right to make changes to the product(s) or information contained herein without notice, and no liability is assumed as a result of their use or application. No rights under any patent accompany the sale of any such product(s) or information.

# Mouser Electronics

Authorized Distributor

Click to View Pricing, Inventory, Delivery & Lifecycle Information:

[ABB:](#)

[IND033](#)