

USB / Microcontroller Module (Lead-Free)

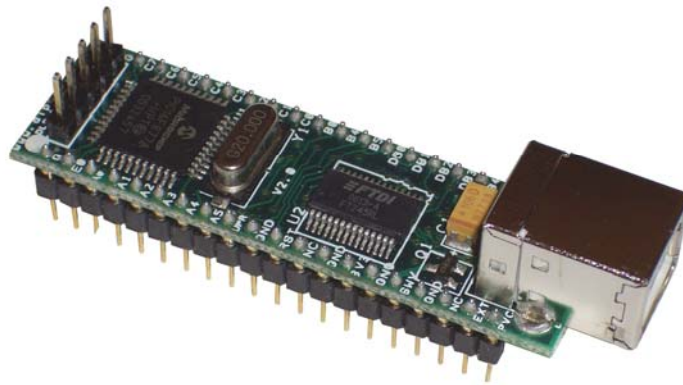

The DLP-245PB-G combines the same USB interface used in the DLP-USB245M-G module with a Microchip PIC microcontroller to form a rapid development tool. The 16F877A microcontroller is preprogrammed with basic functionality for accessing the port pins and can be reprogrammed with user hex code via a 5-pin header using a device programmer (purchased separately).

DLP-245PB-G FEATURES

- Send/receive data over USB to a host computer at up to 2 megabits per second
- 18 digital I/O lines (6 can be configured as A/D inputs) plus the 8-bit data bus available for interfacing to user electronics
- Microchip 16F877A processor with 8K FLASH ROM, 368 bytes RAM, and a multi-channel, 10-bit A/D converter
- “Token I/O” code preprogrammed into the 16F877A’s ROM for basic port pin input/output capability including access to the A/D, EEPROM, and external digital temperature sensors. ROM can be easily erased and reprogrammed with a user-supplied compatible programmer
- No in-depth knowledge of USB is required as all USB protocol is handled automatically by the on-board FT245RL and its support circuitry

- Royalty-free device drivers eliminate the need for USB driver development in most cases
- USB bulk or isochronous data-transfer modes
- Required 5V supply can be taken directly from the USB port or supplied by user electronics
- USB 1.1 and USB 2.0 compatible
- USB VID, PID, serial number, and product description strings stored in EEPROM memory
- Virtual com port (VCP) drivers for:
 - Windows 98 and Windows 98 SE
 - Windows 2000/ME/XP
 - Windows CE
 - MAC OS-8 and OS-9
 - MAC OS-X
 - Linux 2.40 and greater
- D2XX (USB direct drivers + DLL S/W interface)
 - Windows 98 and Windows 98 SE
 - Windows 2000/ME/XP

APPLICATION AREAS

- Prototype development
- USB ISDN and ADSL modems
- USB interface for digital cameras
- USB interface for MP3 players
- High-speed USB instrumentation
- USB smart-card readers
- Set top box (STB) PC-USB interface
- USB hardware modems
- USB wireless modems
- USB bar code readers

GENERAL DESCRIPTION

The DLP-245PB-G provides a cost-effective, microcontroller-based method of interfacing an electronic peripheral to a host computer via USB.

To send data from the peripheral to the host computer, the microcontroller simply writes the byte-wide data into the FT245RL when TXE# is low. If the FT245RL's transmit buffer fills up or is busy storing the previously written byte, it will take its TXE# high in order to stop further data from being written until some of the FIFO data has been transferred over USB to the host.

When the host sends data to the peripheral over USB, the FT245RL will take RXF# low to let the microcontroller know that at least one byte of data is available. The microcontroller then reads the data until RXF# goes high indicating that no more data is available to read.

By using FTDI's virtual COM port drivers, the peripheral looks like a standard COM port to the application software. Commands to set the baud rate are ignored--the FT245RL always transfers data at its fastest rate regardless of the application's baud-rate setting. The latest versions of the drivers are available for download from DLP Design's website at <http://www.dlpdesign.com>.

DRIVER SOFTWARE

FTDI's VCP (virtual COM port) driver-executable files are provided royalty free on the condition that they are used only with designs incorporating an FTDI device (i.e. the FT245RL and DLP-245PB-G). The latest version of the drivers can be downloaded from dlpdesign.com or ftdichip.com.

The VCP driver download file is a combined set of drivers for Windows 98, Windows ME, and Windows 2000/XP. Unzip the file to a blank floppy disk or folder on your PC. (The drivers can coexist on the same floppy disk or folder since the INF files determine which set of drivers to load for each operating system version.) Once loaded, the VCP drivers allow your application software running on the host PC to communicate with the DLP-245PB-G as though it were connected to a COM (RS-232) port.

In addition to VCP drivers, FTDI's D2XX direct drivers for Windows offer an alternative solution to the VCP drivers that allow application software to interface with the DLP-245PB-G using a DLL instead of a virtual com port. The architecture of the D2XX drivers consists of a Windows WDM

driver that communicates with the FT245RL device via the Windows USB stack and a DLL that interfaces the application software (written in VC++, C++ Builder, Delphi, VB, etc.) to the WDM driver. An INF installation file, uninstaller program, and D2XX Programmer's Guide complete the package.

The D2XX direct drivers add support for simultaneous access and control of multiple FT245RL devices. The extended open function (FT_OpenEx) allows the device to be opened either by its product description or serial number, both of which can be programmed to be unique. The list devices function (FT_ListDevices) allows the application software to determine which devices are currently available for use, again by product description or by serial number.

Download FTDI Application Notes AN232-03, AN232-05, AN232-06, and AN232-07 for detailed instructions on how to install and remove the drivers.

EEPROM WRITE UTILITY

The DLP-245PB-G has the option to accept manufacturer-specific information that is written into on-board EEPROM memory. Parameters that can be programmed include the VID and the PID identifiers, the manufacturer's product string, and a serial number.

MPROG is the latest EEPROM serializer and testing utility from FTDI for the FT245RL device. MPROG is based on the new D2XX drivers and will work on Windows 98, Windows ME, and Windows 2000/XP platforms. You must install the latest release of the D2XX drivers in order to run this application. (Refer to the MPROG user's guide for details on the program's use.)

If you have VCP drivers installed on the PC that will be used to perform the EEPROM memory, you must uninstall these drivers using the Add-Remove-Program and install the D2XX drivers prior to running the MPROG.

QUICK START GUIDE

This guide requires the use of a Windows 98/2000/XP PC that is equipped with a USB port.

1. Download the DLL (D2XX) version of the device drivers from either dlpdesign.com or ftdichip.com. Unzip the drivers onto a blank floppy disk or into a folder on the hard drive.
2. The DLP-245PB-G can be configured to receive its operating power from the USB port or from user electronics. Pins 18, 19, and 20 allow for this configuration. (Refer to the Pinout Description in the next section for a detailed description of the DLP-245PB-G electrical interface.)

Note: The board will not operate until a power source has been selected as mentioned in Step 2.

3. Connect the DLP-245PB-G board to the PC via a standard A-B, 6-foot USB cable. This action initiates the loading of the USB drivers. When prompted, select the folder where the DLL version of the device drivers was stored in Step 1. Windows will then complete the installation of the device drivers for the DLP-245PB-G board. The next time the DLP-245PB-G board is attached, the host PC will immediately load the correct drivers without any prompting. Reboot the PC if prompted to do so.

The DLP-245PB-G is shipped with default VID, PID, etc. values programmed into the EEPROM memory. You only need to run MPROG if you want to change the default values.

At this point, the DLP-245PB-G is ready for use. Note that the DLP-245PB-G will appear non-responsive if data sent from the host PC is not read from the FT245RL device by the 16F877A microcontroller.

If changing drivers from the VCP to the DLL type (or vice versa), you must first uninstall the currently loaded drivers. To accomplish this, first disconnect the DLP-245PB-G adapter from the host computer and then use Add-Remove-Programs in Control Panel.

TOKEN I/O

The 16F877A microcontroller on the DLP-245PB-G is shipped from the factory preprogrammed with firmware that provides rudimentary access to the port pins via either the VCP or DLL drivers. Features include the ability to read and write individual port pins as well as 8-bit port reads and writes.

The firmware in the DLP-245PB-G also provides access to the 16F877A's A/D converter, EEPROM memory, and communications with digital temperature-sensing devices.

Commands sent to the Token I/O firmware must adhere to a specific communications protocol. Each command sequence contains the following information:

Byte 0:	Number of bytes in command sequence
Byte 1:	Command
Byte 2...n-1:	Parameter/Data bytes
Byte n:	Checksum

The checksum is computed by exclusive-OR-ing every byte in the string. If the same checksum is calculated by the 16F877A upon receipt of the packet, then a single-byte reply of 0x55 is returned to the host. In the event of a checksum error, the 16F877A will return an error code of 0xAA. For example, setting port PIN_A1 high would require the following string of bytes:

0x03, 0xA6, 0x29, 0x01, 0x8D

Definition of the Bytes:

0x03 – Number of bytes in command (checksum excluded)

0xA6 – Command for set port pin high/low

0x29 – Affected port pin

0x01 – Desired state of port pin

0x8D – Checksum of previous 4 bytes

The port pins equate to hexadecimal numeric constants as defined here:

PORT A:

PIN_A0 0x28, PIN_A1 0x29, PIN_A2 0x2A,

PIN_A3 0x2B, PIN_A4 0x2C, PIN_A5 0x2D

PORT B:

PIN_B0 0x30, PIN_B1 0x31, PIN_B2 0x32, PIN_B3 0x33,
PIN_B4 0x34, PIN_B5 0x35, PIN_B6 0x36, PIN_B7 0x37

PORT C:

PIN_C0 0x38, PIN_C1 0x39, PIN_C2 0x3A, PIN_C3 0x3B,
PIN_C4 0x3C, PIN_C5 0x3D, PIN_C6 0x3E, PIN_C7 0x3F

PORT D:

PIN_D0 0x40, PIN_D1 0x41, PIN_D2 0x42, PIN_D3 0x43,
PIN_D4 0x44, PIN_D5 0x45, PIN_D6 0x46, PIN_D7 0x47

PORT E:

PIN_E0 0x48, PIN_E1 0x49, PIN_E2 0x4A, PIN_E3 0x4B,
PIN_E4 0x4C, PIN_E5 0x4D, PIN_E6 0x4E, PIN_E7 0x4F

The source code for the Token I/O firmware (developed for the CCS C compiler) is available as a free download upon purchase and receipt of the hardware. Example Visual C++ source code (for Windows 98/2000/XP) for communicating with the DLP-245PB-G via the Token I/O firmware is also available for download. The windows source code also contains the port pin definitions listed above.

TOKEN I/O COMMAND SET

0xA5 – Line In – Reads the state of a single port pin

Parameters: Port – Select from available port pins (PIN_A3, PIN_B0, etc)
Returns: 1 Byte: State of the port pin (0 or 1)
Function: This function will read the state of a single port pin. If the data direction for the pin selected was set to output, the direction is first set to input.
Example: 0x2, 0xA5, 0x2B, 0x8C - Reads the current state of port pin PIN_A3.

0xA6 – Line Out - Sets a single port pin high or low

Parameters: Port – Select from available port pins (PIN_A3, PIN_B3, etc)
State – 0 or 1
Returns: Undefined
Function: This function will change the output state of a single port pin. If the data direction for the pin selected was set to input, the direction is first set to output.
Example: 0x3, 0xA6, 0x2B, 0x1, 0x8F – Sets port pin PIN_A3 high.

0xA7 – Return Board ID

Parameters: None
Returns: 5 bytes: “245PB”
Function: This function will return the ID of the board currently opened.
Example: 0x1, 0xA7, A6 – Reads the board ID.

0xA8 – Setup A/D

Parameters: Port Configuration – Selects analog port configuration. (See command 0xA8 in the example firmware for options.)
A/D Conversion Clock – Select the source for the A/D conversion clock. (See command 0xA8 in the example firmware for options.)
Returns: Undefined
Function: This function will select the source for the A/D conversion clock. (Refer to the datasheet for the 16F877A for a detailed explanation of the conversion clock.)
Example: 0x3, 0xA8, 0x0, 0x7, 0xAC – Sets all available A/D inputs on the DLP-245PB-G to analog mode (0x0) and selects the internal A/D clock (0x7).

0xA9 – A/D Conversion

- Parameters:** Analog Port Number – Selects the analog port for the A/D conversion.
- Returns:** 2 Bytes: The 10-bit voltage data; LSB first.
- Function:** This function will set the channel for the A/D conversion, pause 10uS, perform the A/D conversion, and then return 2 bytes to the host (LSB first). Command 0xA8 must have been previously called to configure the desired analog channel as an A/D input.
- Example:** 0x2, 0xA9, 0x2, 0xA9 – Selects analog channel 2 (AN2), performs the A/D conversion, and returns 2 bytes of data.

0xAA – EEPROM Read

- Parameters:** Address – Selects the zero-based address of the location in the 16F877A's internal EEPROM for reading.
- Returns:** 1 Byte: The byte of data read from the EEPROM.
- Function:** This function will read the selected location in the 16F877A's internal EEPROM.
- Example:** 0x2, 0xAA, 0x2, 0xAA – Reads EEPROM Address 2, and returns a single byte of data.

0xAB – EEPROM Write

- Parameters:** Address – Selects the zero-based address of the location in the 16F877A's internal EEPROM for writing.
Data – Data to be written to the EEPROM.
- Returns:** Undefined.
- Function:** This function will write the selected location in the 16F877A's internal EEPROM.
- Example:** 0x3, 0xAA, 0x2, 0xFE, 0x55 – Writes a value of 0xFE to EEPROM Address 2.

0xAC – DS18B20 Start Convert

Parameters: Port Pin – Selects the microcontroller port pin on the 16F877A to be used for communication with the DS18B20 temperature sensor.

Returns: 1 Byte: A single byte indicating the result of trying to reset the temperature sensor.

Sensor status definitions:

- 99: Sensor ready
- 8: Short circuit detected
- 2: No sensor detected

Function: This function will select a port pin for communicating with a DS18B20 temperature sensor and start a temperature conversion. In addition to power and ground connections, a 1.5K to 4.7K pull-up resistor must be connected between VCC and the data pin of the DS18B20 for proper communication. The conversion time for the DS18B20 is specified for a maximum of 750 milliseconds.

Example: 0x2, 0xAC, 0x30, 0x9E – Starts a temperature conversion on 16F877A port pin B0.

0xAD – DS18B20 Read Data

Parameters: Port Pin – Selects the microcontroller port pin on the 16F877A to be used for communication with the DS18B20 temperature sensor.

Returns: 9 Bytes: The contents of the scratchpad memory in the DS18B20.

Function: This function will select a port pin for communicating with a DS18B20 temperature sensor and request the current contents of the DS18B20's scratchpad memory. A conversion (command 0xAC) must have been previously requested for the data to be current. Additionally, host software must wait at least 750 milliseconds for the conversion to complete before reading the 9 bytes of data. In addition to power and ground, a 1.5K to 4.7K pull-up resistor must be connected between VCC and the data pin of the DS18B20 for proper communications. (For an example of how to calculate .1°C resolution temperature data from the 9 bytes of return data, refer to the example Windows source code.)

Example: 0x2, 0xAD, 0x30, 0x9F – Requests 9 byte temperature data from 16F877A port pin B0.

0xAE – Reserved

0xAF – Loopback

Parameters: Data byte – The byte of data to be looped back to the host.

Returns: 1 Byte: The data byte written.

Function: This function will echo the specified byte of data back to the host. The port pins are not affected.

Example: 0x2, 0xAF, 0x12, 0xBF – Requests the data byte 0x12 to be echoed back to the host.

0x55 – Port A Read

0x59 – Port C Read

0x5B – Port D Read

Parameters: None

Returns: 1 Byte: The 8-bit data read from the selected port.

Function: This function will read the specified 8-bit port and return the results to the host. The port is automatically configured as an input port. Port A must be configured for digital I/O (command 0xA8) prior to using this command.

Example: 0x1, 0x5B, 0x5A – Requests a read from the 8-bit data bus Port D.

0x56 – Port A Write

0x5A – Port C Write

0x5C – Port D Write

Parameters: Data byte – The byte of data to be written to the 8-bit port.

Returns: Undefined

Function: This function will write the specified data byte to the 8-bit port. Data is latched on the port pins until changed by another command. The port is automatically configured as an output port. Port A must be configured for digital I/O (command 0xA8) prior to using this command.

Example: 0x2, 0x5C, 0x12, 0xBF – Writes the data byte 0x12 to the 8-bit data bus Port D.

TABLE 1: DLP-245PB-G PINOUT DESCRIPTION

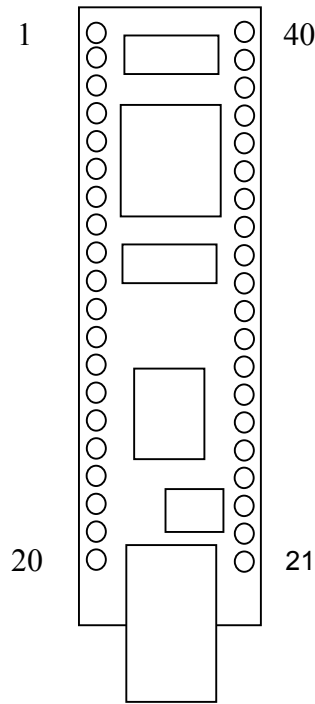

Pin #	Description
1	GROUND
2	E0 (I/O) Port Pin E0 connected to the 16F877A microcontroller. A/D Channel 5.
3	A0 (I/O) Port Pin A0 connected to the 16F877A microcontroller. A/D Channel 0.
4	A1 (I/O) Port Pin A1 connected to the 16F877A microcontroller. A/D Channel 1.
5	A2 (I/O) Port Pin A2 connected to the 16F877A microcontroller. A/D Channel 2.
6	A3 (I/O) Port Pin A3 connected to the 16F877A microcontroller. A/D Channel 3.
7	A4 (I/O) Port Pin A4 connected to the 16F877A microcontroller. Open drain output.
8	A5 (I/O) Port Pin A5 connected to the 16F877A microcontroller. A/D Channel 4.
9	UPRST (In) 16F877A Reset input. Can be left disconnected if not used.
10	GROUND
11	RESET# (In) Can be used by an external device to reset the FT245RL. Can be left disconnected if not used.
12	No connect
13	GROUND
14	3V3OUT (Out) Output from the integrated L.D.O. regulator. Its primary purpose is to provide the internal 3.3v supply to the USB transceiver cell and the RSTOUT# pin. A small amount of current (<=5mA) can be drawn from this pin to power external 3.3v logic if required.

15	GROUND
16	SWVCC (Out) Power from EXTVCC (Pin 19) controlled via Pin 10 (POWER#) of the FT245RL and Q1 MOSFET power switch. R5 and C3 control the power-up rate to help limit inrush current.
17	GROUND
18	No connect
19	EXTVCC (In) Use for applying main power (4.4 to 5.25 volts) to the module. Connect to PORTVCC if the module is to be powered by the USB port (typical configuration).
20	PORTVCC (Out) Power from USB port. Connect to EXTVCC if module is to be powered by the USB port (typical configuration). 500mA is the maximum current available to the DLP-245PB-G and target electronics if the USB device is configured for high power.
21	DB7 (I/O) Line 7 of the data bus between the 16F877A and the FT245RL USB-FIFO.
22	DB6 (I/O) Line 6 of the data bus between the 16F877A and the FT245RL USB-FIFO.
23	DB5 (I/O) Line 5 of the data bus between the 16F877A and the FT245RL USB-FIFO.
24	DB4 (I/O) Line 4 of the data bus between the 16F877A and the FT245RL USB-FIFO.
25	DB3 (I/O) Line 3 of the data bus between the 16F877A and the FT245RL USB-FIFO.
26	DB2 (I/O) Line 2 of the data bus between the 16F877A and the FT245RL USB-FIFO.
27	DB1 (I/O) Line 1 of the data bus between the 16F877A and the FT245RL USB-FIFO.
28	DB0 (I/O) Line 0 of the data bus between the 16F877A and the FT245RL USB-FIFO.
29	B5 (I/O) Port Pin B5 connected to the 16F877A microcontroller.
30	B4 (I/O) Port Pin B4 connected to the 16F877A microcontroller.
31	B0 (I/O) Port Pin B0 connected to the 16F877A microcontroller.
32	C0 (I/O) Port Pin C0 connected to the 16F877A microcontroller.
33	C1 (I/O) Port Pin C1 connected to the 16F877A microcontroller.
34	C2 (I/O) Port Pin C2 connected to the 16F877A microcontroller.
35	C3 (I/O) Port Pin C3 connected to the 16F877A microcontroller.
36	C4 (I/O) Port Pin C4 connected to the 16F877A microcontroller.
37	C5 (I/O) Port Pin C5 connected to the 16F877A microcontroller.
38	C6 (I/O) Port Pin C6 connected to the 16F877A microcontroller.
39	C7 (I/O) Port Pin C7 connected to the 16F877A microcontroller.
40	GROUND

MECHANICAL DRAWINGS (PRELIMINARY)
INCHES (MILLIMETERS) UNLESS OTHERWISE NOTED

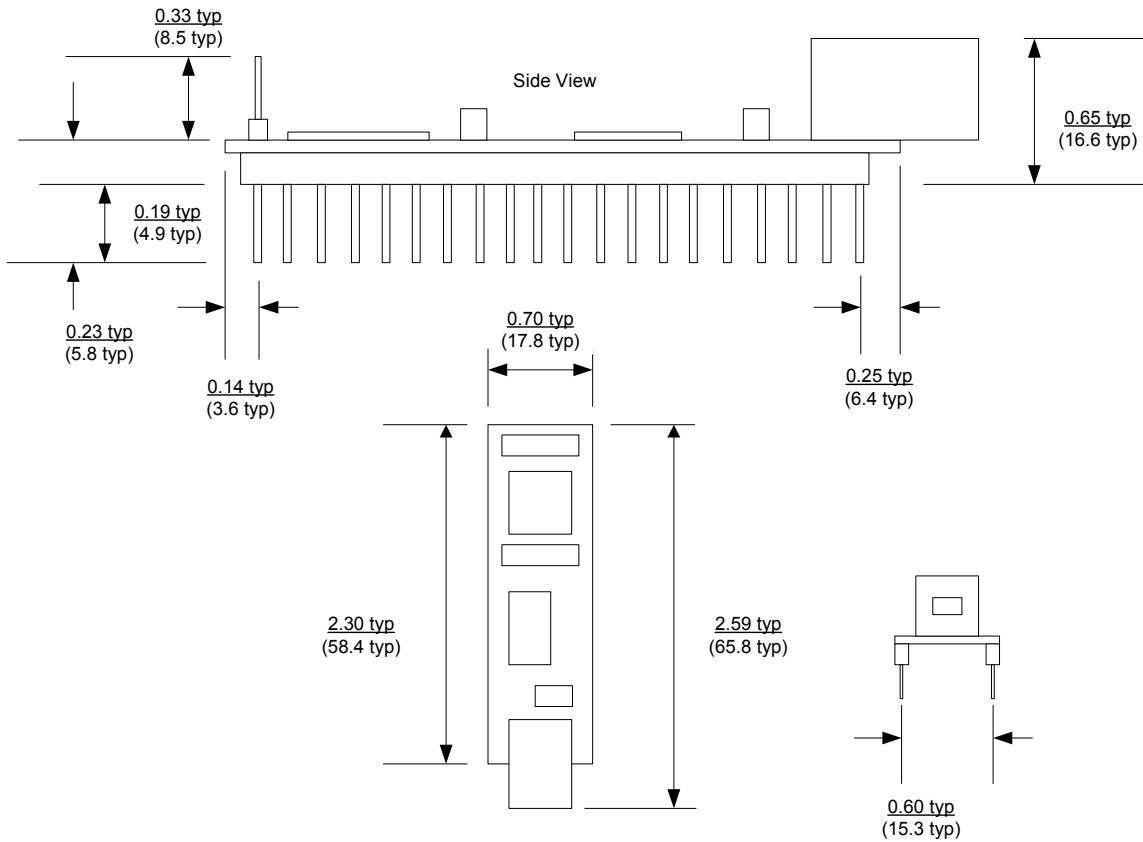

DISCLAIMER

Neither the whole nor any part of the information contained within or the product described in this datasheet may be adapted or reproduced in any material or electronic form without the prior written consent of the copyright holder.

This product and its documentation are supplied on an as-is basis, and no warranty as to their suitability for any particular purpose is either made or implied. DLP Design will not accept any claim for damages whatsoever arising as a result of use or failure of this product. Your statutory rights are not affected.

This product or any variant of it is not intended for use in any medical appliance, device, or system in which the failure of the product might reasonably be expected to result in personal injury.

This document provides preliminary information that may be subject to change without notice.

CONTACT INFORMATION

DLP Design

1605 Roma Lane

Allen, TX 75013

Phone: 469-964-8027

Fax: 415-901-4859

Email: support@dlpdesign.com

Internet: <http://www.dlpdesign.com>

DLP-245PB-G

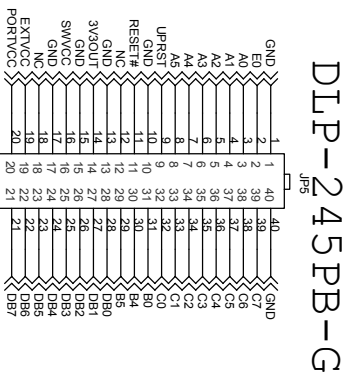
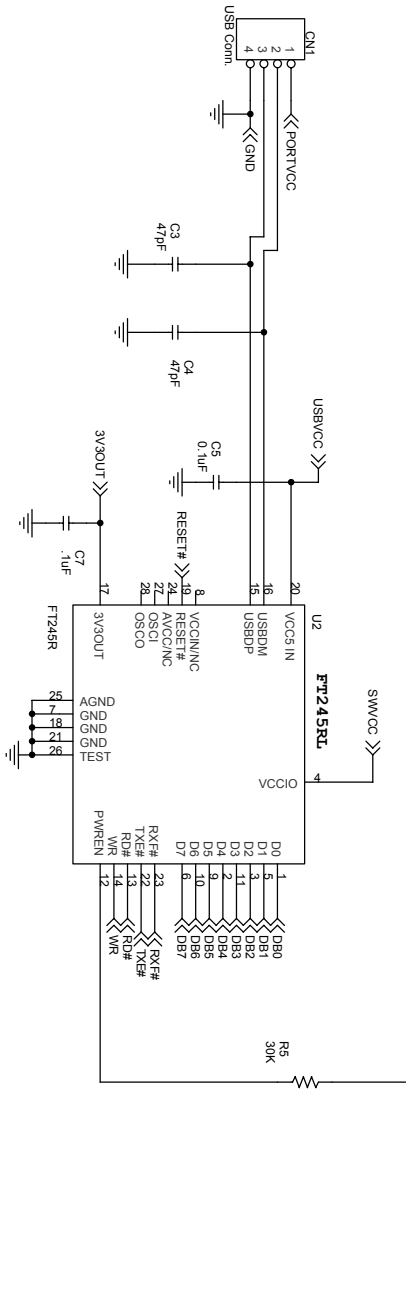
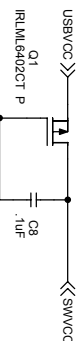
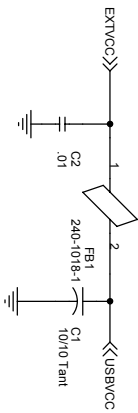

CONN PCB 20x2

DLP-245PB-G

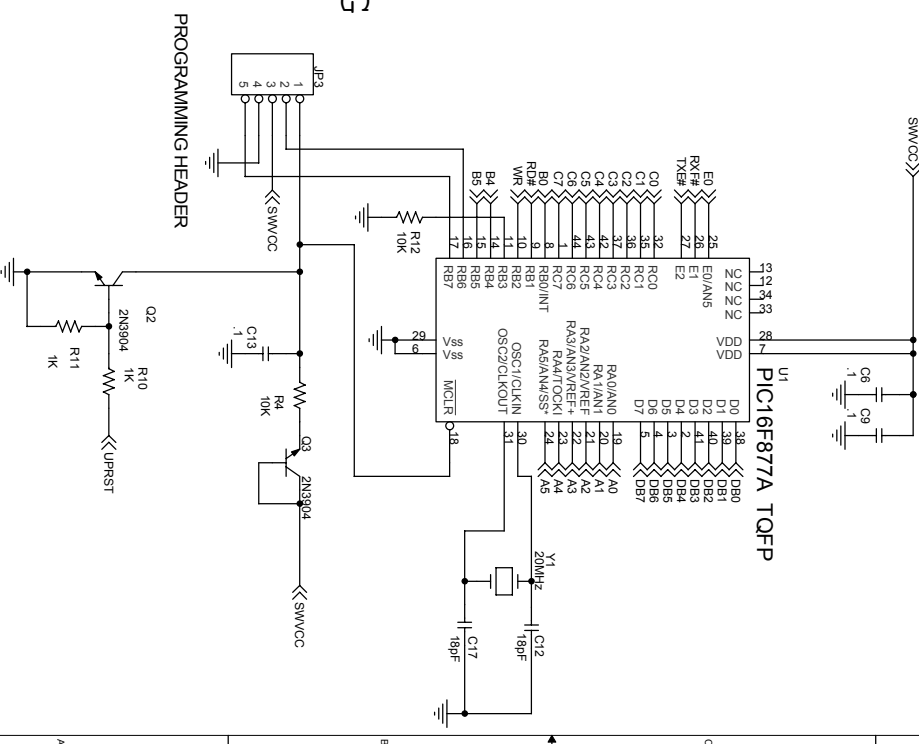

PROGRAMMING HEADER

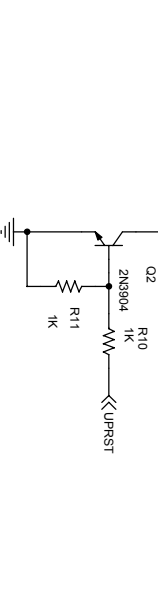

Mouser Electronics

Authorized Distributor

Click to View Pricing, Inventory, Delivery & Lifecycle Information:

[FTDI:](#)

[DLP-245PB-G](#) [DLP-245PB-G + CCS Compiler](#)