



MODEL: SJ3-350134A-X7 | **DESCRIPTION:** AUDIO JACK

FEATURES

- wave solder
- IPX7



SPECIFICATIONS

| parameter | conditions/description | min | typ | max | units |
|----------------------------|------------------------|-----|-------|-----|--------|
| rated input voltage | | | 30 | | Vdc |
| rated input current | | | | 0.5 | A |
| contact resistance | | | | 30 | mΩ |
| insulation resistance | at 500 Vdc | 100 | | | MΩ |
| voltage withstand | for 1 minute | | | 500 | Vac |
| insertion/withdrawal force | | 0.3 | | 3 | kg |
| operating temperature | | -20 | | 70 | °C |
| storage temperature | | -40 | | 85 | °C |
| life | | | 5,000 | | cycles |
| flammability rating | UL94V-0 | | | | |
| RoHS | yes | | | | |
| IP level | IPX7 | | | | |

SOLDERABILITY

| parameter | conditions/description | min | typ | max | units |
|----------------|--------------------------------------|-----|-----|-----|-------|
| wave soldering | dipped in solder pot for 4~6 seconds | | 250 | | °C |

MECHANICAL DRAWING

units: mm
 tolerance:
 X.X ±0.38 mm
 X.XX ±0.30 mm
 X.XXX ±0.15 mm
 PCB: ±0.05 mm
 unless otherwise specified
 PCB thickness: 1.6 mm

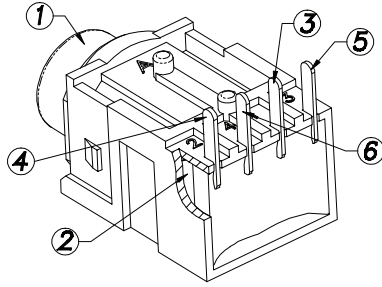

| ITEM | DESCRIPTION | MATERIAL | PLATING/COLOR |
|------|-------------|---------------------------|------------------------|
| 1 | housing | PBT [UL94V-0] | black |
| 2 | cover | PA66 [UL94HB] | black |
| 3 | terminal 1 | phosphor bronze t=0.25 | 8 μ" over 40 μ" nickel |
| 4 | terminal 2 | phosphor bronze t=0.30 | 8 μ" over 40 μ" nickel |
| 5 | terminal 3 | phosphor bronze t=0.25 | 8 μ" over 40 μ" nickel |
| 6 | terminal 4 | phosphor bronze t=0.25 | 8 μ" over 40 μ" nickel |

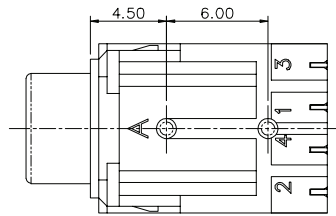
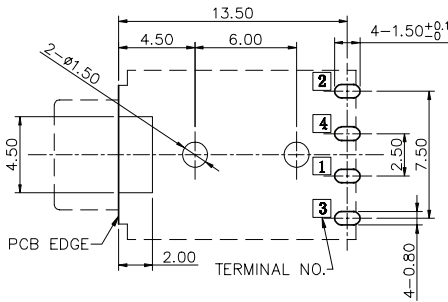
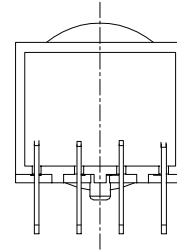
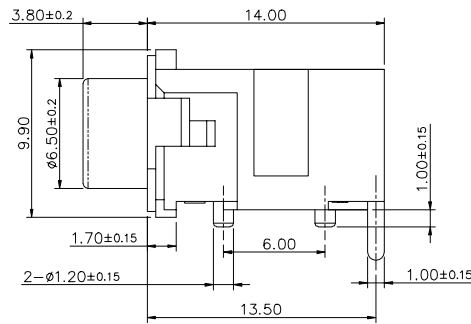
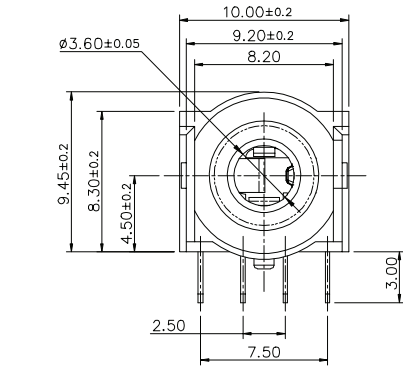

Recommended PCB Layout
Top View

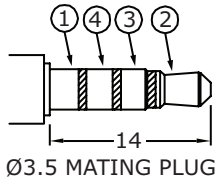

| | |
|-----------|----------------|
| Model No. | SJ3-350134A-X7 |
| Schematic | |
| PIN | |
| 1 | sleeve |
| 2 | tip |
| 3 | ring 1 |
| 4 | ring 2 |

REVISION HISTORY

| rev. | description | date |
|------|-----------------|------------|
| 1.0 | initial release | 09/25/2024 |

The revision history provided is for informational purposes only and is believed to be accurate.



Same Sky offers a one (1) year limited warranty. Complete warranty information is listed on our website.

Same Sky reserves the right to make changes to the product at any time without notice. Information provided by Same Sky is believed to be accurate and reliable. However, no responsibility is assumed by Same Sky for its use, nor for any infringements of patents or other rights of third parties which may result from its use.

Same Sky products are not authorized or warranted for use as critical components in equipment that requires an extremely high level of reliability. A critical component is any component of a life support device or system whose failure to perform can be reasonably expected to cause the failure of the life support device or system, or to affect its safety or effectiveness.

[sameskydevices.com](https://www.sameskydevices.com)

Mouser Electronics

Authorized Distributor

Click to View Pricing, Inventory, Delivery & Lifecycle Information:

[Same Sky:](#)

[SJ3-350134A-X7](#)