



SERIES: PT01 | DESCRIPTION: ROTARY POTENTIOMETER

FEATURES

- carbon element
- wide variety of mounting styles
- multiple shaft options
- available with center detent
- linear, logarithmic, and reverse logarithmic tapers



SPECIFICATIONS

parameter	conditions/description	min	typ	max	units
maximum operating voltage	linear and logarithmic (audio)			20 50	Vdc Vac
power rating	linear and logarithmic (audio)			0.05	W
taper	linear and logarithmic (audio)				
standard resistance range	see Resistance Table	1.0		1,000	k Ω
standard resistance tolerance			± 20		%
residual resistance	50 Ω or $\pm 1\%$ max				
sliding noise				68	mV
operating temperature		-10		60	$^{\circ}\text{C}$
hand soldering	for 3 seconds max			300	$^{\circ}\text{C}$
RoHS	yes				

MECHANICAL

parameter	conditions/description	min	typ	max	units
mechanical angle		275	280	285	$^{\circ}$
rotational torque		10		150	gf-cm
detent torque		20		200	gf-cm
stop strength		2			kg-cm
rotational life			10,000		cycles
weight			2.5		g

PART NUMBER KEY

PT01 - X X XX X - X XXX

Base Number

Terminal Configuration:

- A = Vertical/Rear Mount w/Sleeve Bushing
- B = Horizontal/Side Mount, Bushingless, 10 mm Height
- C = Horizontal/Side Mount, Bushingless, 6.5 mm Height
- D = Vertical/Rear Mount, Bushingless
- E = Vertical/Rear Mount w/Plastic Plain Bushing
- F = Vertical/Rear Mount w/Metal Threaded Bushing
- G = Horizontal/Side Mount w/Sleeve Bushing, 6.5 mm Height
- H = Horizontal/Side Mount w/Sleeve Bushing, 10 mm Height

Detent:
1 = No Detent
2 = Center Detent

Shaft Length:
15 = 15 mm
20 = 20 mm
25 = 25 mm
30 = 30 mm

Shaft Style:
D = D-cut
K1 = Knurled (18 teeth)
K2 = Knurled (40 teeth)

Resistance Taper:
A = Logarithmic
B = Linear
C = Reverse Logarithmic

Resistance (Ω):
102 = 1,000
202 = 2,000
502 = 5,000
103 = 10,000
203 = 20,000
503 = 50,000
104 = 100,000
204 = 200,000
504 = 500,000
105 = 1,000,000

SCHEMATIC/TAPERS

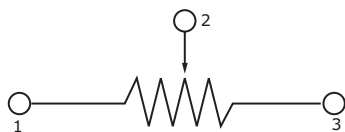

Resistance Table	
Resistance (Ω)	Code
1,000	102
2,000	202
5,000	502
10,000	103
20,000	203
50,000	503
100,000	104
200,000	204
500,000	504
1,000,000	105

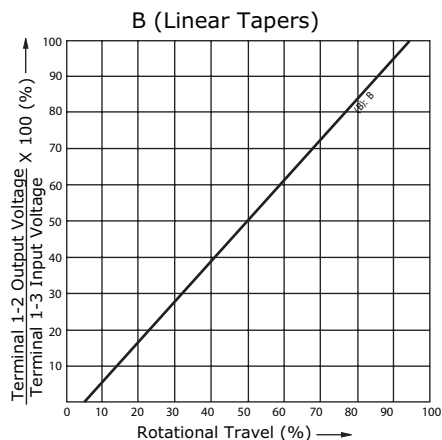
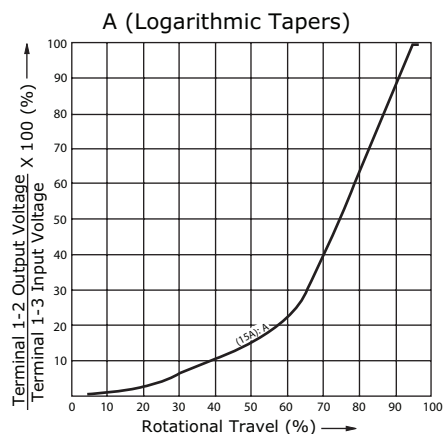

SHAFT TYPES

units: mm [inch]
 tolerance: ±0.3 mm
 unless otherwise noted

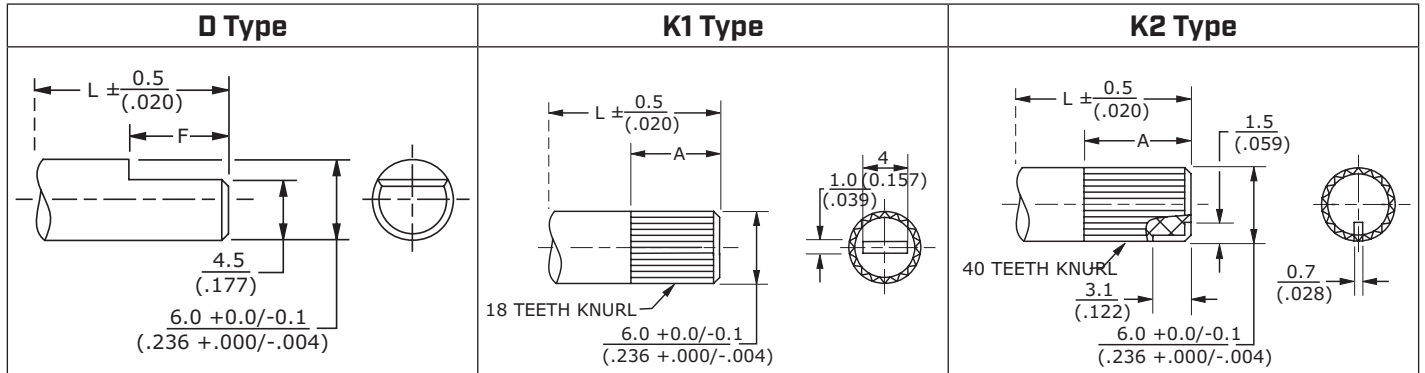

	15D	20D	25D	30D
L	15	20	25	30
F	6	7	12	12

	15K1	20K1	25K1	30K1
L	15	20	25	30
A	6	7	12	12

	15K2	20K2	25K2	30K2
L	15	20	25	30
A	6	7	12	12

MECHANICAL DRAWING (VERTICAL/REAR MOUNT W/SLEEVE BUSHING)

units: mm [inch]
 tolerance:
 X ≤ 10: ±0.3 mm
 10 < X ≤ 30: ±0.5 mm
 30 < X ≤ 100: ±1.0 mm
 unless otherwise noted

ITEM	DESCRIPTION	MATERIAL	PLATING/COLOR
A	base	PBT [UL94V-0]	black
B	shaft	PC [UL94V-0]	black
C	reed	nickel-zinc alloy	
D	bracket	iron	bright tin
E	terminals	cold rolled steel	dark tin

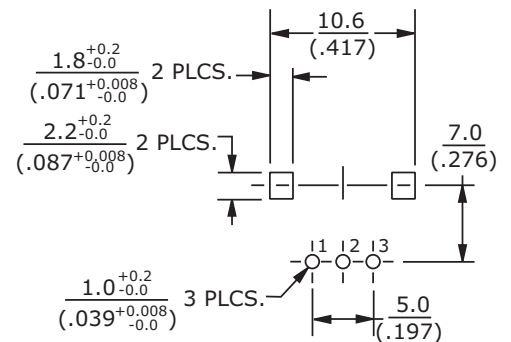
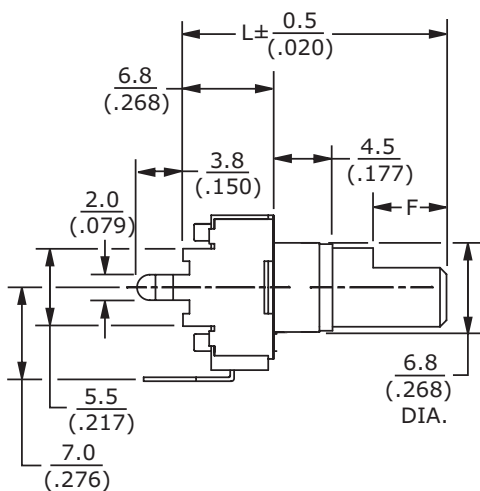

Recommended PCB Layout
 Top View

MECHANICAL DRAWING (HORIZONTAL/SIDE MOUNT, BUSHINGLESS, 10 MM HEIGHT)

units: mm [inch]
 tolerance:
 $X \leq 10$: ± 0.3 mm
 $10 < X \leq 30$: ± 0.5 mm
 $30 < X \leq 100$: ± 1.0 mm
 unless otherwise noted

ITEM	DESCRIPTION	MATERIAL	PLATING/COLOR
A	base	PBT (UL94V-0)	black
B	shaft	PC (UL94V-0)	black
C	reed	nickel-zinc alloy	
D	bracket	iron	bright tin
E	terminals	cold rolled steel	dark tin

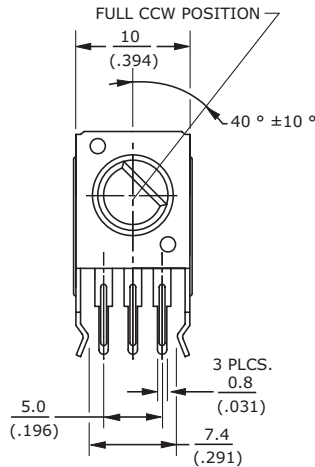

Recommended PCB Layout
Top View

MECHANICAL DRAWING (HORIZONTAL/SIDE MOUNT, BUSHINGLESS, 6.5 MM HEIGHT)

units: mm [inch]
 tolerance:
 $X \leq 10$: ± 0.3 mm
 $10 < X \leq 30$: ± 0.5 mm
 $30 < X \leq 100$: ± 1.0 mm
 unless otherwise noted

ITEM	DESCRIPTION	MATERIAL	PLATING/COLOR
A	base	PBT (UL94V-0)	black
B	shaft	PC (UL94V-0)	black
C	reed	nickel-zinc alloy	
D	bracket	iron	bright tin
E	terminals	cold rolled steel	dark tin

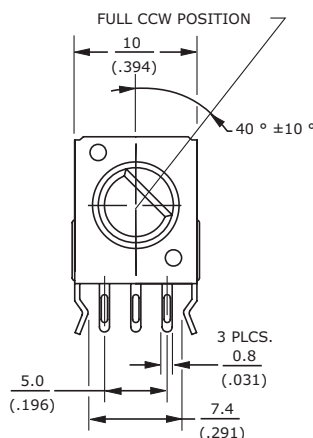

Recommended PCB Layout
Top View

MECHANICAL DRAWING (VERTICAL/REAR MOUNT, BUSHINGLESS)

units: mm [inch]
 tolerance:
 $X \leq 10$: ± 0.3 mm
 $10 < X \leq 30$: ± 0.5 mm
 $30 < X \leq 100$: ± 1.0 mm
 unless otherwise noted

ITEM	DESCRIPTION	MATERIAL	PLATING/COLOR
A	base	PBT [UL94V-0]	black
B	shaft	PC [UL94V-0]	black
C	reed	nickel-zinc alloy	
D	bracket	iron	bright tin
E	terminals	cold rolled steel	dark tin

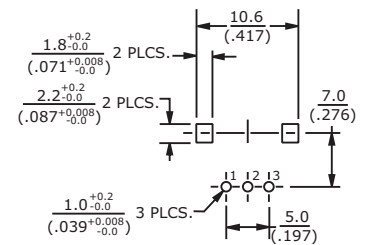
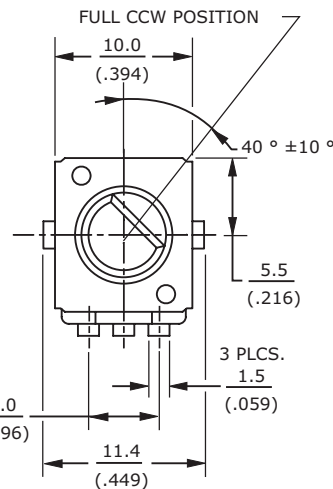
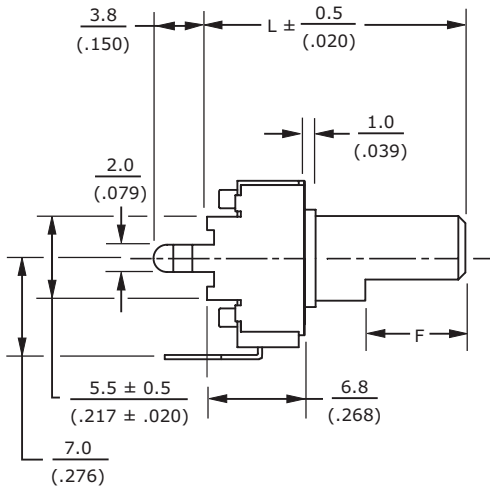

Recommended PCB Layout Top View

MECHANICAL DRAWING (VERTICAL/REAR MOUNT W/PLASTIC PLAIN BUSHING)

units: mm [inch]
 tolerance:
 $X \leq 10$: ± 0.3 mm
 $10 < X \leq 30$: ± 0.5 mm
 $30 < X \leq 100$: ± 1.0 mm
 unless otherwise noted

ITEM	DESCRIPTION	MATERIAL	PLATING/COLOR
A	base	PBT [UL94V-0]	black
B	shaft	PC [UL94V-0]	black
C	reed	nickel-zinc alloy	
D	bracket	iron	bright tin
E	terminals	cold rolled steel	dark tin

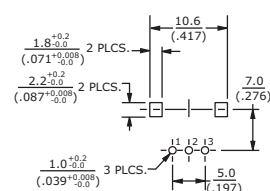
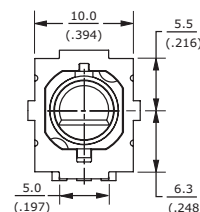
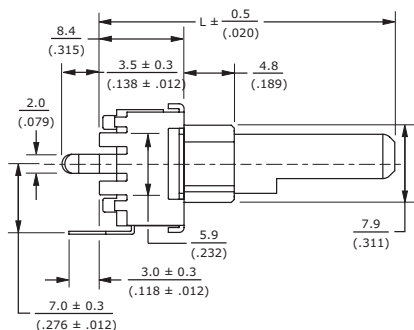

Recommended PCB Layout Top View

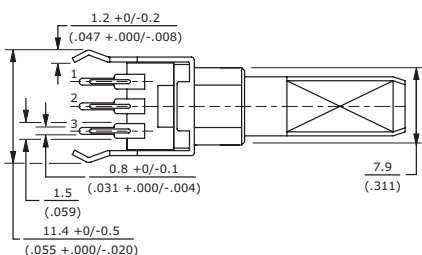

MECHANICAL DRAWING (VERTICAL/REAR MOUNT W/METAL THREADED BUSHING)

units: mm [inch]
 tolerance:
 $X \leq 10$: ± 0.3 mm
 $10 < X \leq 30$: ± 0.5 mm
 $30 < X \leq 100$: ± 1.0 mm
 unless otherwise noted

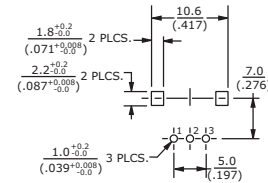
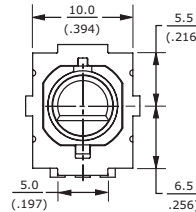

Recommended PCB Layout
Top View

ITEM	DESCRIPTION	MATERIAL	PLATING/COLOR
A	base	PBT (UL94V-0)	black
B	shaft	PC (UL94V-0)	black
C	reed	nickel-zinc alloy	
D	bracket	iron	bright tin
E	terminals	cold rolled steel	dark tin

MECHANICAL DRAWING (HORIZ/SIDE MNT W/SLEEVE BUSHING, 6.5 MM HEIGHT)

units: mm [inch]
 tolerance:
 $X \leq 10$: ± 0.3 mm
 $10 < X \leq 30$: ± 0.5 mm
 $30 < X \leq 100$: ± 1.0 mm
 unless otherwise noted

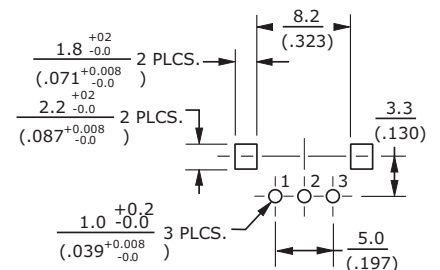
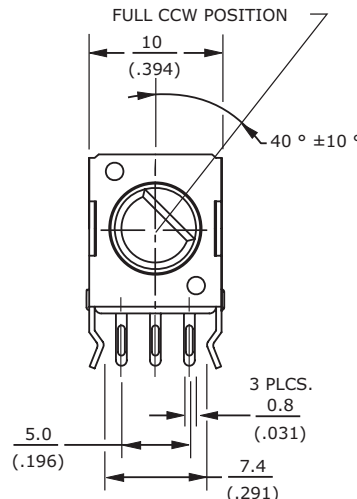

Recommended PCB Layout
Top View

ITEM	DESCRIPTION	MATERIAL	PLATING/COLOR
A	base	PBT (UL94V-0)	black
B	shaft	PC (UL94V-0)	black
C	reed	nickel-zinc alloy	
D	bracket	iron	bright tin
E	terminals	cold rolled steel	dark tin

MECHANICAL DRAWING (HORIZ/SIDE MNT W/SLEEVE BUSHING, 10 MM HEIGHT)

units: mm [inch]
 tolerance:
 $X \leq 10$: ± 0.3 mm
 $10 < X \leq 30$: ± 0.5 mm
 $30 < X \leq 100$: ± 1.0 mm
 unless otherwise noted

ITEM	DESCRIPTION	MATERIAL	PLATING/COLOR
A	base	PBT (UL94V-0)	black
B	shaft	PC (UL94V-0)	black
C	reed	nickel-zinc alloy	
D	bracket	iron	bright tin
E	terminals	cold rolled steel	dark tin

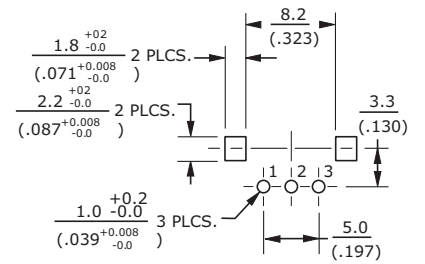
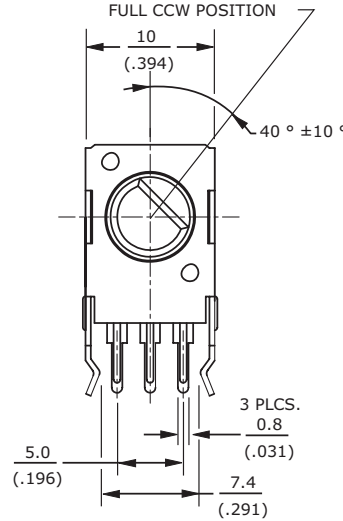
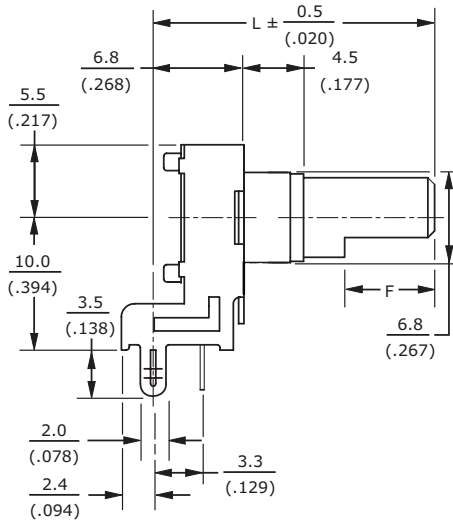

Recommended PCB Layout Top View

MOUNTING HARDWARE

units: mm [inch]

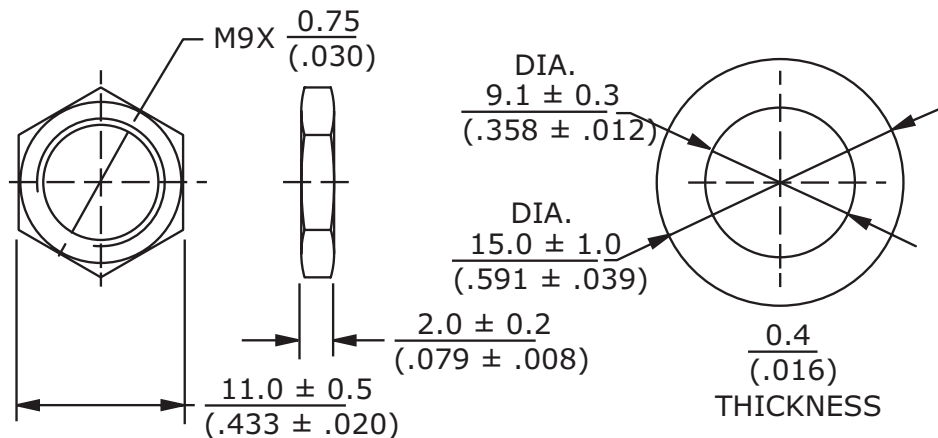

Note: Hex nut and washer supplied with threaded bushing version.

REVISION HISTORY

rev.	description	date
1.0	initial release	12/15/2021
1.01	logo, datasheet style update	08/05/2022
1.02	updated taper detail	01/15/2024
1.03	updated datasheet	04/18/2024
1.04	CUI Devices rebranded to Same Sky	09/12/2024

The revision history provided is for informational purposes only and is believed to be accurate.



Same Sky offers a one (1) year limited warranty. Complete warranty information is listed on our website.

Same Sky reserves the right to make changes to the product at any time without notice. Information provided by Same Sky is believed to be accurate and reliable. However, no responsibility is assumed by Same Sky for its use, nor for any infringements of patents or other rights of third parties which may result from its use.

Same Sky products are not authorized or warranted for use as critical components in equipment that requires an extremely high level of reliability. A critical component is any component of a life support device or system whose failure to perform can be reasonably expected to cause the failure of the life support device or system, or to affect its safety or effectiveness.

[sameskydevices.com](https://www.sameskydevices.com)

Mouser Electronics

Authorized Distributor

Click to View Pricing, Inventory, Delivery & Lifecycle Information:

[Same Sky:](#)

[PT01-D125D-B503](#)