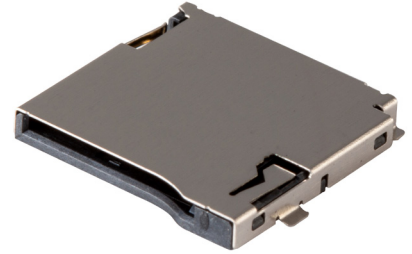

MODEL: MSD-1-A | **DESCRIPTION:** MICRO SD CARD CONNECTOR**FEATURES**

- micro SD card connector
- push in, auto eject out
- card detect switch
- gold flash
- surface mount
- UL94V-0

**SPECIFICATIONS**

| parameter | conditions/description | min | typ | max | units |
|---------------------------------|---|-------|-------|-----|--------|
| rated voltage | | | | 30 | V |
| rated current | | | | 0.5 | A |
| contact resistance ¹ | | | | 100 | mΩ |
| insulation resistance | at 500 Vdc, between adjacent circuits | 1,000 | | | MΩ |
| voltage withstand | for 1 minute, between adjacent circuits | | 100 | | Vac |
| insertion force | at a rate of 25 mm/min | | | 10 | N |
| withdrawal force | at a rate of 25 mm/min | 0.5 | | | N |
| life | | | 5,000 | | cycles |
| operating temperature | | -40 | | 85 | °C |
| flammability rating | UL94V-0 | | | | |
| RoHS | yes | | | | |

Note: 1. When measured at 20 mV / 100 mA.

SOLDERABILITY

| parameter | conditions/description | min | typ | max | units |
|------------------|--|-----|-----|-----|-------|
| reel storage | at relative humidity 40-70% reel opened: use within 1 month reel unopened: up to 15 month shelf life | 16 | 22 | 28 | °C |
| reflow soldering | see reflow profile | | | 250 | °C |

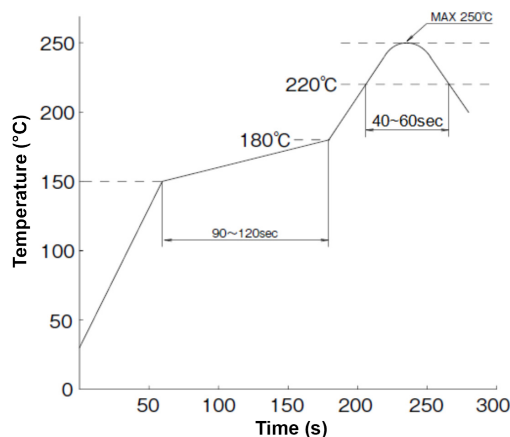

MECHANICAL DRAWING

units: mm
 tolerance:
 X.X ±0.38 mm
 X.XX ±0.25 mm
 X.XXX ±0.10 mm
 unless otherwise specified

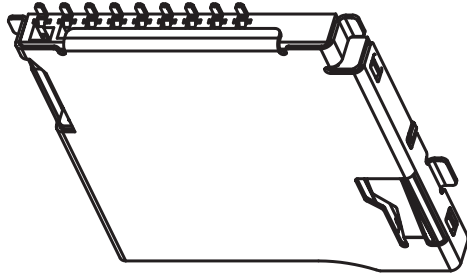

| DESCRIPTION | MATERIAL | PLATING/COLOR |
|-------------------|------------------------------|--|
| housing | LCP 30% GF [UL94V-0] | black |
| contact terminals | phosphor bronze t=0.15 mm | contact area: gold flash over nickel solder area: tin over nickel |
| cover | SUS304 t=0.15 mm | nickel |

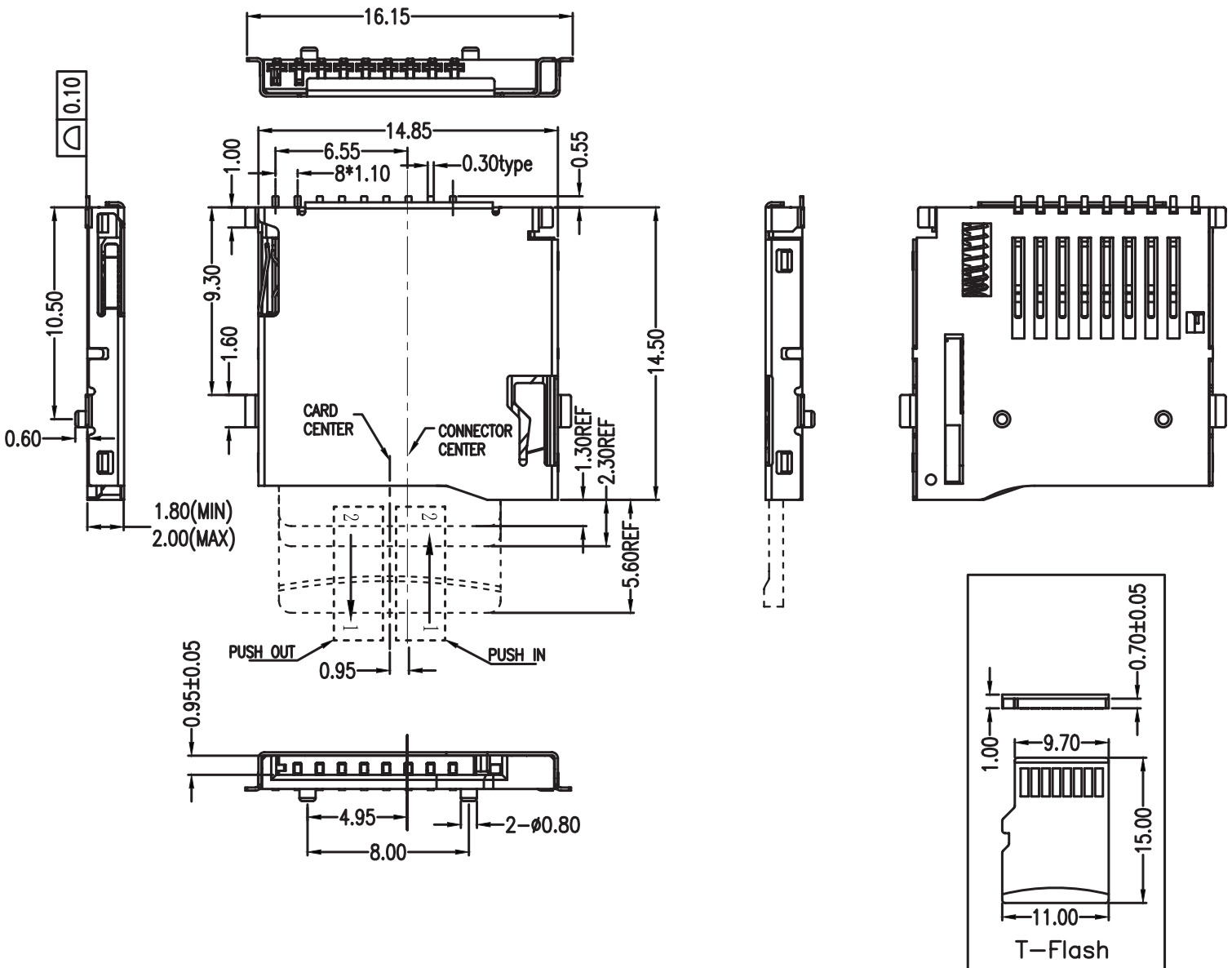

MECHANICAL DRAWING (CONTINUED)

units: mm
PCB tolerance: ±0.05 mm

| PIN CONNECTIONS | | | |
|-----------------|-------------|--------|---------------------------------|
| PIN | SIGNAL NAME | TYPE | DESCRIPTION |
| 1 | DAT2 | I/O/PP | DATA LINE [BIT 2] |
| 2 | CD/DAT3 | I/O/PP | CARD DETECT / DATA LINE [BIT 3] |
| 3 | CMD | PP | COMMAND / RESPONSE |
| 4 | VDD | S | SUPPLY VOLTAGE |
| 5 | CLK | I | CLOCK |
| 6 | VSS | S | SUPPLY VOLTAGE GROUND |
| 7 | DAT0 | I/O/PP | DATA LINE [BIT 0] |
| 8 | DAT1 | I/O/PP | DATA LINE [BIT 1] |
| CD | - | - | CARD DETECT SWITCH |
| GND | - | - | COVER GROUND |

| CARD STATUS | |
|--------------|---------------|
| WITHOUT CARD | CARD INSERTED |
| | |

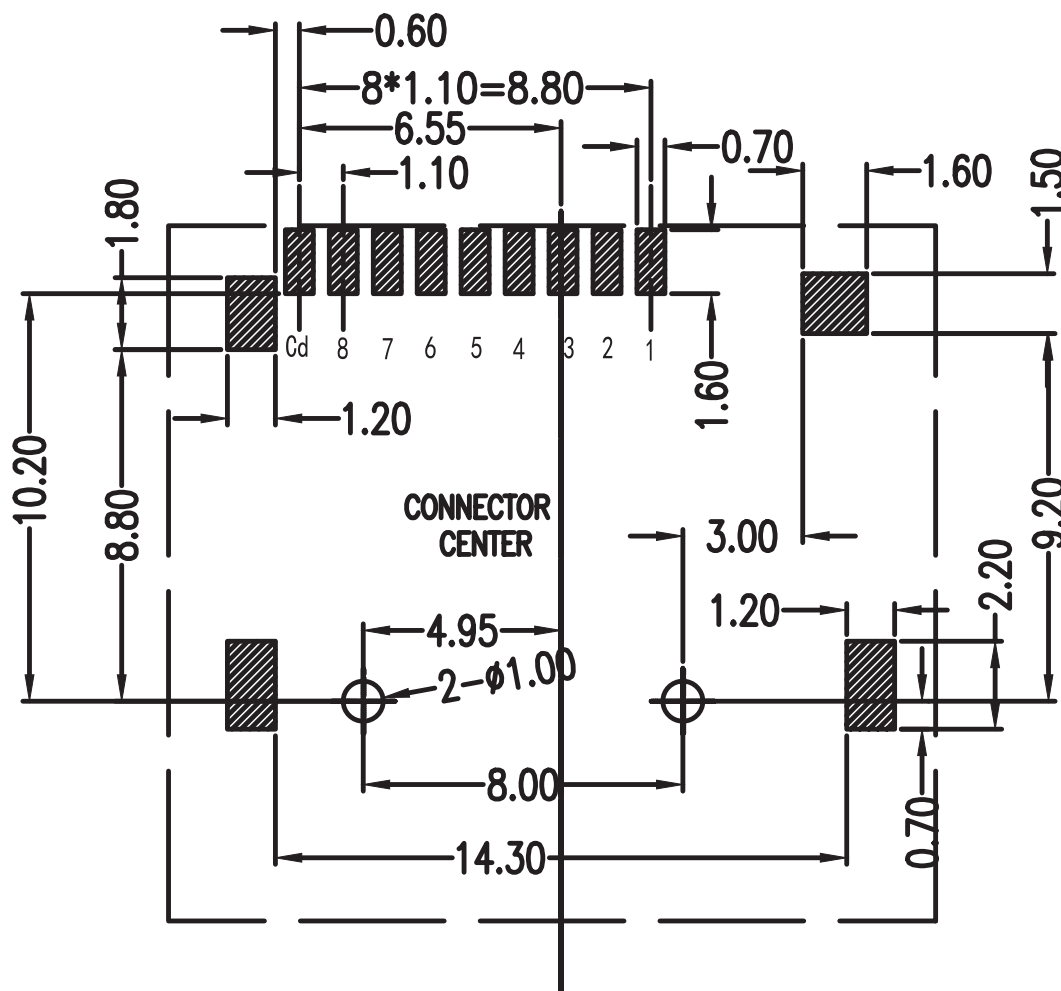

Recommended PCB Layout
Top View

PACKAGING

units: mm

Reel Size: $\varnothing 330$ mm

Reel QTY: 1,000 pcs per reel

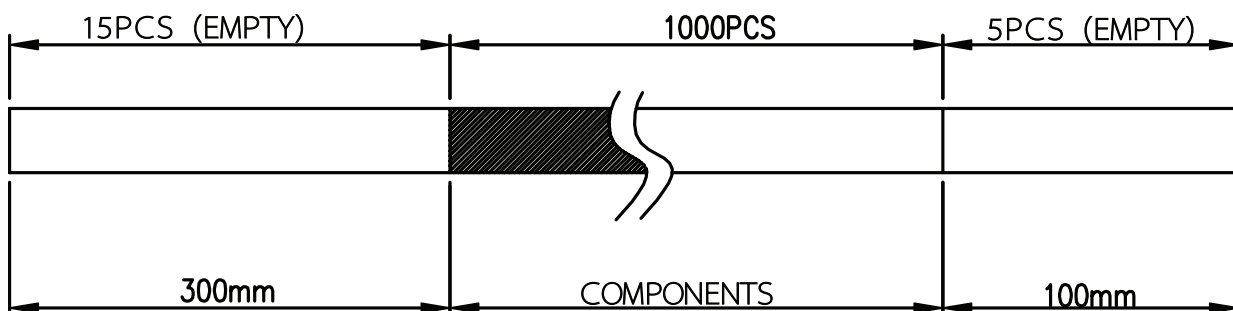
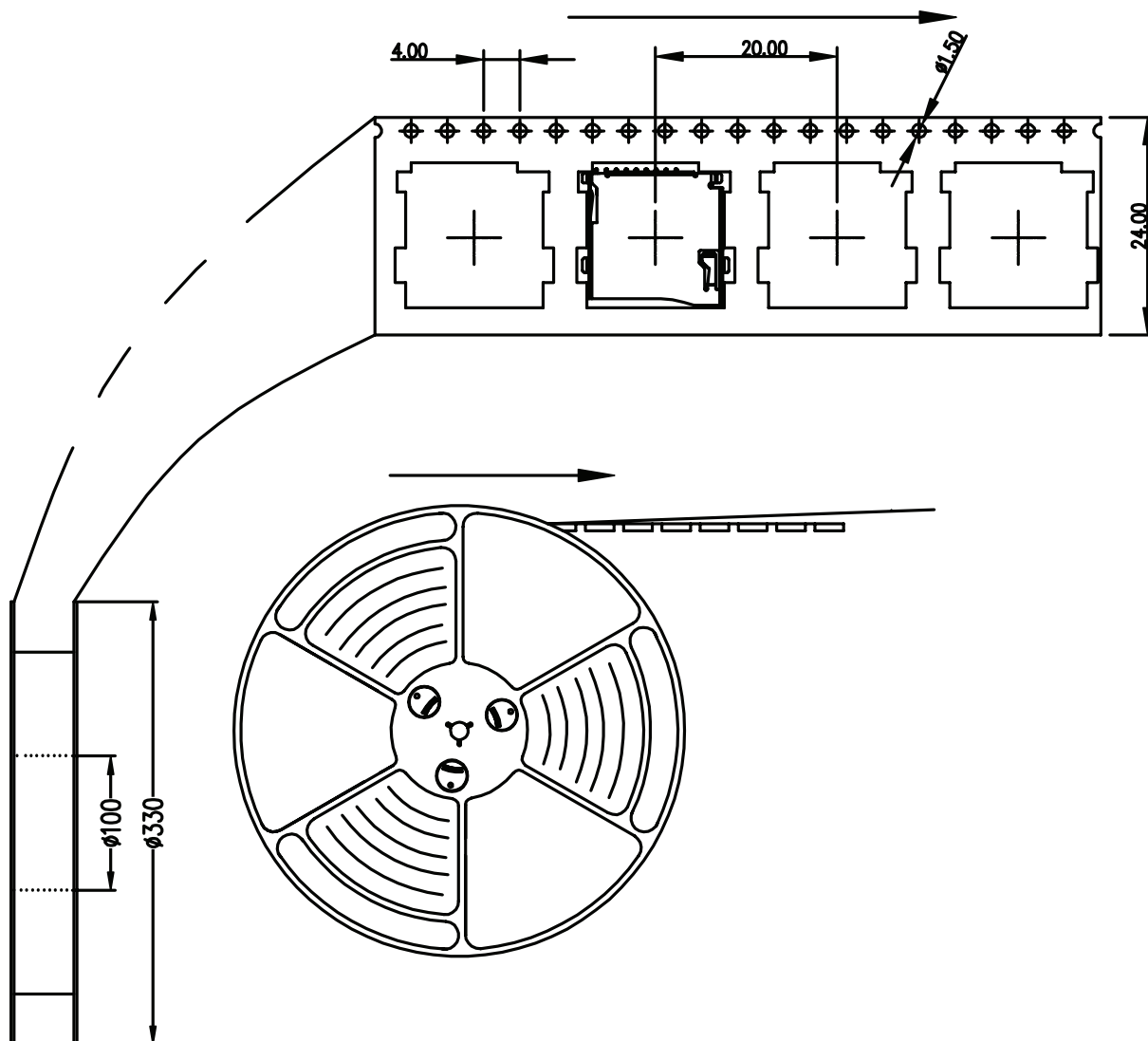

REVISION HISTORY

| rev. | description | date |
|------|-----------------------------------|------------|
| 1.0 | initial release | 10/24/2023 |
| 1.01 | CUI Devices rebranded to Same Sky | 09/12/2024 |

The revision history provided is for informational purposes only and is believed to be accurate.



Same Sky offers a one (1) year limited warranty. Complete warranty information is listed on our website.

Same Sky reserves the right to make changes to the product at any time without notice. Information provided by Same Sky is believed to be accurate and reliable. However, no responsibility is assumed by Same Sky for its use, nor for any infringements of patents or other rights of third parties which may result from its use.

Same Sky products are not authorized or warranted for use as critical components in equipment that requires an extremely high level of reliability. A critical component is any component of a life support device or system whose failure to perform can be reasonably expected to cause the failure of the life support device or system, or to affect its safety or effectiveness.

[sameskydevices.com](https://www.sameskydevices.com)

Mouser Electronics

Authorized Distributor

Click to View Pricing, Inventory, Delivery & Lifecycle Information:

[Same Sky:](#)

[MSD-1-A](#)