



**SERIES:** CAF-A7B | **DESCRIPTION:** AC AXIAL FAN

**FEATURES**

- dual ball bearing
- 172 x 51 mm frame
- 110~125 or 220~240 Vac
- multiple speed options



**MODEL**

MODEL	input voltage	input current <sup>1</sup>	input power <sup>1</sup>	rated speed <sup>1</sup>	airflow <sup>2</sup>	static pressure <sup>3</sup>	noise <sup>4</sup>
	rated [50/60 Hz] [Vac]	max [50/60 Hz] [A]	[50/60 Hz] [W±3]	typ [50/60 Hz] [RPM±10%]	[50/60 Hz] [CFM]	[50/60 Hz] [inch H <sub>2</sub> O]	typ [50/60 Hz] [dBA]
CAF-A751B-119-320	110	0.28/0.26	19.0/16.0	2,000 <sup>6</sup> /1,300 <sup>6</sup>	133.23/76.06	0.16/0.08	46.9/31.5
CAF-A751B-124-410	110	0.32/0.31	21.3/19.8	2,400 <sup>6</sup> /1,400 <sup>6</sup>	149.33/87.36	0.26/0.10	49.1/35.8
CAF-A751B-126-450	110	0.45/0.44	29.1 <sup>5</sup> /29.1 <sup>5</sup>	2,600/2,600	164.50/160.47	0.45/0.26	51.9/51.2
CAF-A751B-219-320	220	0.15/0.14	18.3/16.0	2,000 <sup>6</sup> /1,300 <sup>6</sup>	133.23/76.06	0.16/0.08	47.2/30.7
CAF-A751B-224-410	220	0.23/0.23	28.0/28.1	2,400 <sup>6</sup> /2,200 <sup>6</sup>	162.04/140.81	0.41/0.17	51.3/49.0
CAF-A751B-226-450	220	0.26/0.25	32.1 <sup>7</sup> /31.0 <sup>7</sup>	2,600/2,600	164.50/160.47	0.45/0.26	51.7/52.1

- Notes:
1. At rated voltage, will reach bottom line of specifications after 5 minutes. Will reach standard specification after 10 minutes continuously running.
  2. At rated voltage, room temperature, 65% humidity, 0 inch H<sub>2</sub>O static pressure.
  3. At rated voltage, 0 CFM airflow.
  4. Measured in an anechoic chamber as per ISO3745/GB4214-84 at rated voltage, with background noise 10±2 dBA at 1 m from the fan intake.
  5. Typical input power is measured as W±10% at rated voltage.
  6. Typical rated speed is measured as RPM±250 at rated voltage.
  7. Typical input power is measured as W±3.5 at rated voltage.
  8. All specifications are measured at 25°C, 65% relative humidity unless otherwise specified.

## INPUT

parameter	conditions/description	min	typ	max	units
operating input voltage	110 Vac input models	100	110	125	Vac
	220 Vac input models	220		240	Vac
starting voltage	110 Vac input models		85		Vac
	220 Vac input models		175		Vac
locked current	CAF-A751B-119-320 (50/60 Hz)		0.29/0.24		A
	CAF-A751B-124-410 (50/60 Hz)		0.36/0.30		A
	CAF-A751B-126-450 (50/60 Hz)		0.57/0.47		A
	CAF-A751B-219-320 (50/60 Hz)		0.15/0.13		A
	CAF-A751B-224-410 (50/60 Hz)		0.26/0.22		A
	CAF-A751B-226-450 (50/60 Hz)		0.30/0.25		A

## PROTECTIONS / FEATURES

parameter	conditions/description	min	typ	max	units
impedance protected motor	on all models				
insulated type	Class B (130 °C)				

## SAFETY & COMPLIANCE

parameter	conditions/description	min	typ	max	units
insulation resistance	at 500 Vdc between frame and both lead wires	10			MΩ
dielectric strength	for 1 minute at 1 mA between frame and lead wires		1500		Vac
safety approvals	UL/cUL 507, TUV (EN 60335-1:2012+A11+A13+A14+A15, EN 60335-2-80:2003+A1+A2, EN 62233:200*)				
EMI/EMC	EN 55014-1:2017+A11, EN/IEC 61000-3-2:2019, EN 61000-3-3:2013+A1, EN 55014-2:2015				
life expectancy	at 25°C, 65% RH, 90% confidence level		70,000		hours
RoHS	yes				

## ENVIRONMENTAL

parameter	conditions/description	min	typ	max	units
operating temperature		-10		70	°C
storage temperature		-40		80	°C

## PERFORMANCE CURVES

**CAF-A751B-119-320**

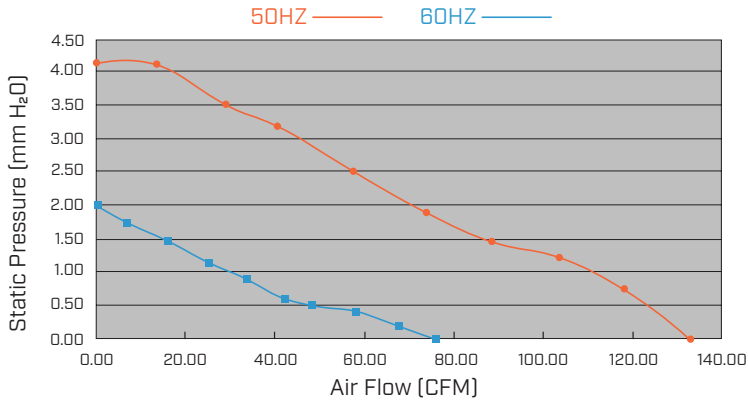

**CAF-A751B-124-410**

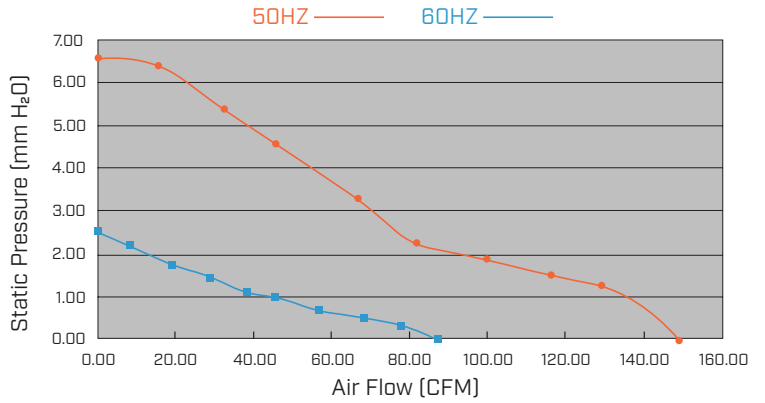

**CAF-A751B-126-450**

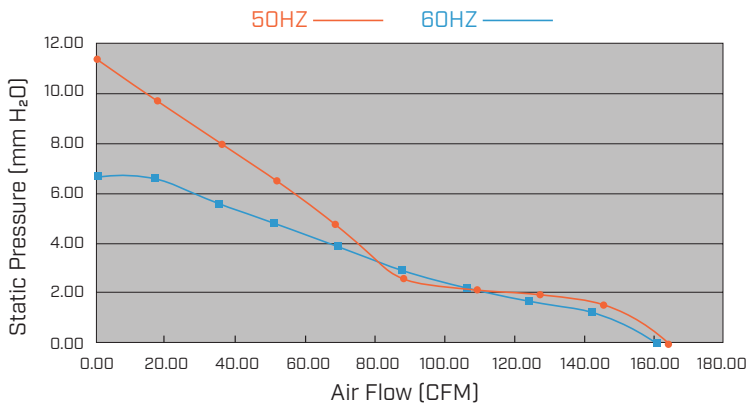

**CAF-A751B-219-320**

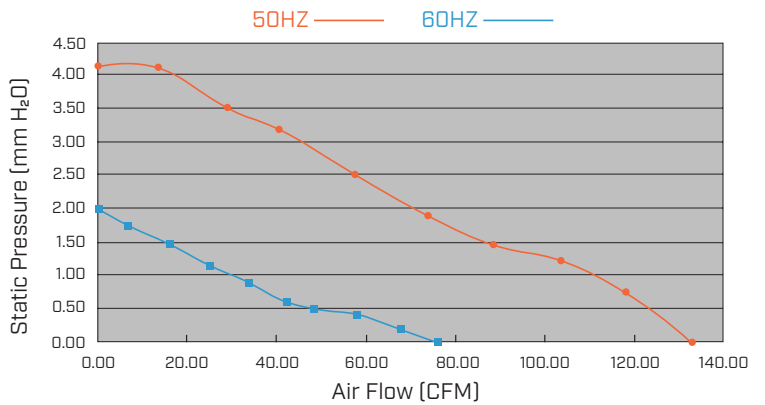

**CAF-A751B-224-410**

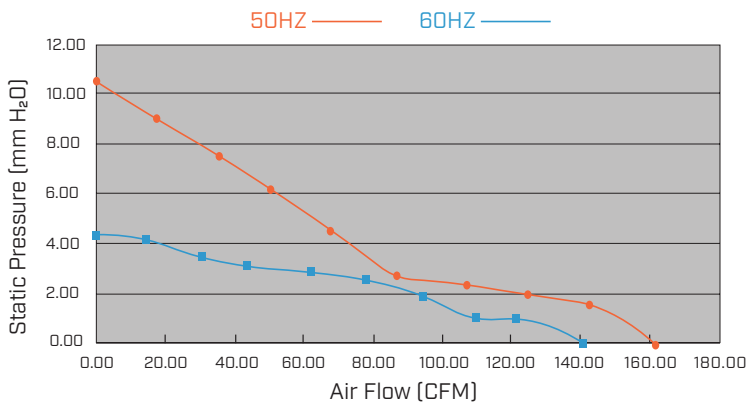

**CAF-A751B-226-450**

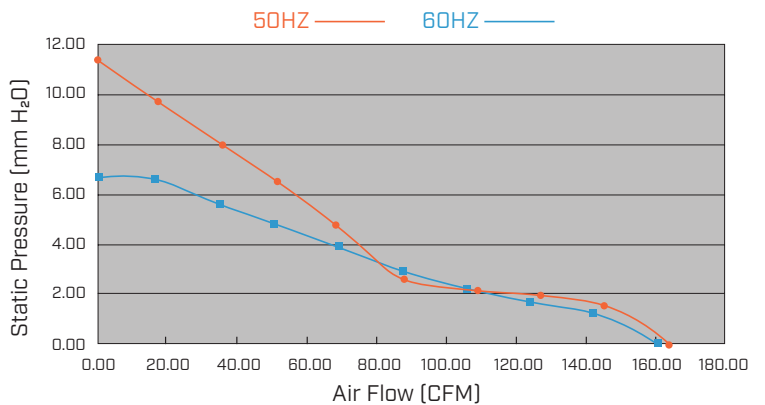

## MECHANICAL

parameter	conditions/description	min	typ	max	units
motor	AC brushless				
bearing system	dual ball bearing				
direction of rotation	counter-clockwise viewed from front of fan blade				
dimensions	171.0 x 151.5 x 51.5				mm
material	fan frame: aluminum fan impellar: PBT (UL94V-0)				
weight	weight varies by model	851		900	g

## MECHANICAL DRAWING

units: mm

wires: UL 1015, 22 AWG

MOUNTING SCREW (Pan Head)			
Screw Type	Mounting Hole	Screw Size	Torque
Machine Screw	M4X0.7	M4X0.7	1.5 N-m
Machine Screw	M5X0.8	M5X0.8	2.0 N-m

WIRE CONNECTIONS	
Wire Color	Function
Black	+Vin
Black	-Vin

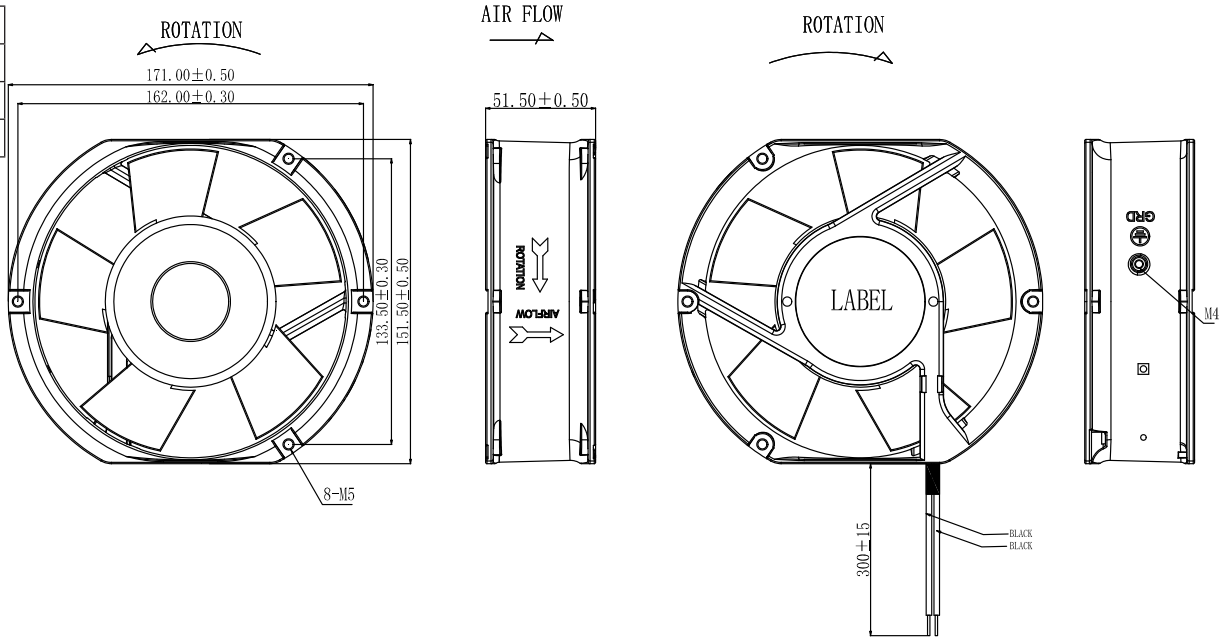

## REVISION HISTORY

rev.	description	date
1.0	initial release	10/17/2023
1.01	adjusted frame size	05/06/2024
1.02	CUI Devices rebranded to Same Sky	09/12/2024

The revision history provided is for informational purposes only and is believed to be accurate.



Same Sky offers a one (1) year limited warranty. Complete warranty information is listed on our website.

Same Sky reserves the right to make changes to the product at any time without notice. Information provided by Same Sky is believed to be accurate and reliable. However, no responsibility is assumed by Same Sky for its use, nor for any infringements of patents or other rights of third parties which may result from its use.

Same Sky products are not authorized or warranted for use as critical components in equipment that requires an extremely high level of reliability. A critical component is any component of a life support device or system whose failure to perform can be reasonably expected to cause the failure of the life support device or system, or to affect its safety or effectiveness.

[sameskydevices.com](https://www.sameskydevices.com)

# Mouser Electronics

Authorized Distributor

Click to View Pricing, Inventory, Delivery & Lifecycle Information:

[Same Sky:](#)

[CAF-A751B-119-320](#) [CAF-A751B-124-410](#) [CAF-A751B-126-450](#) [CAF-A751B-219-320](#) [CAF-A751B-224-410](#) [CAF-A751B-226-450](#)