

Altech Corp.®

Serving the Automation & Control Industry Since 1984



Quality
Endorsed
Company



Process Control, Monitoring & Protection Devices

Altech Corp.®

Since 1984, Altech Corporation has grown to become a leading supplier of automation and industrial control components. Headquartered in Flemington, NJ, Altech has an experienced staff of engineering, manufacturing and sales personnel to provide the highest quality products with superior service. This is the Altech Commitment!

With experienced Product Engineers and Customer Service personnel, Altech provides solutions to your most pressing application challenges. All with one thought in mind - *to ensure that we solve your problem the first time!*

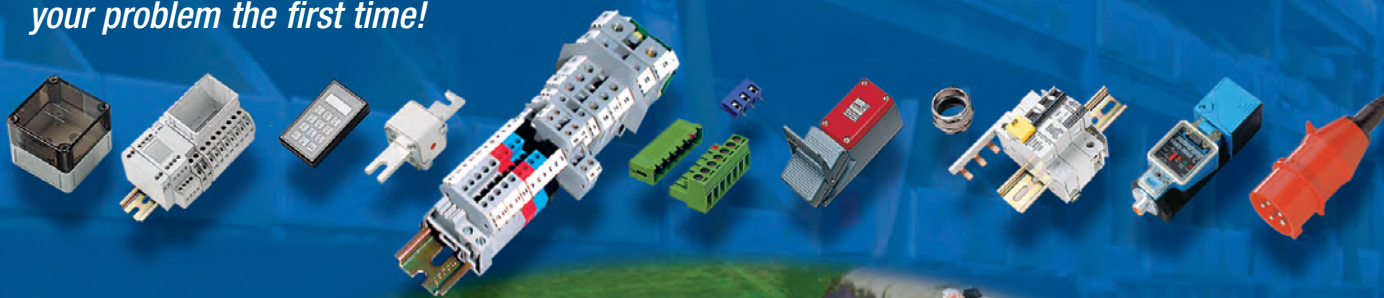

Quality Commitment

Altech's control components meet diverse national and international standards such as UL, NEC, CSA, IEC, VDE and more. Altech provides superior customer service and delivery through Total Quality Management and Continuous Process Improvement. Altech is ISO 9001 approved. We perform these services with honesty and integrity and are committed to achieve these goals.



Analog / Digital Protection Relays4



Voltage / Phase Protection Relay LED Indication5
 (600VPR)
 Phase Protection Relay LED Indication.....6
 (600PSR)
 Current Leakage Relay Liquid Crystal Display with Backlight.....7
 (900ELR-2)
 Voltage / Phase / Frequency Protection Relay Liquid Crystal Display8-9
 (900VPR-2, 900VPR-BL-U)
 Current Protection Relay Liquid Crystal Display10-12
 (900CPR-1, 900CPR-3)
 Current Transformer12-13
 (SPCT)
 Closed Toroid for Leakage Current Protection.....14
 (CBCT)

Control.....15



Temperature Controllers 7 Segment LED Display16-23
 (TC513AX, TC203AX, TC303AX, TC533AX, TC544A, TC244AX, TC344AX,
 PID500, PID110, PID330)
 Cooling Controller 7 Segment LED Display24
 (CH403)
 Process Indicator 7 Segment LED Display.....25-26
 (PIC101N, PIC152N)
 Counter 7 Segment LED Display27-29
 (XC410, XC1200, XTC5400)
 Rate Indicator 7 Segment LED Display.....30
 (RC102C)

Timing31



Digital Timer Panel Mount.....32
 (XT5042)
 Analog Timer Plug Mount33-35
 (55XU, 55ES, 55XC)
 Digital Timer 17.5mm DIN Rail36
 (600DT)
 Analog Timer 17.5mm DIN Rail.....37-38
 (600XU, 600SD)
 Analog Timer 22.5mm DIN Rail.....39-40
 (800XU, 800XC)

Technical Annex

Index41
 Timing Diagrams42-43
 Digital Panel Meters44-45
 Terms and Conditions.....46

Analog / Digital Protection Relays

Protection

Altech is pleased to offer a variety of protection relays covering:

- Phase Monitoring
- Voltage Monitoring
- Current Monitoring
- Frequency Monitoring
- Current Leakage / Ground Fault Monitoring

Protection relays help to maintain systems and ensure that proper action is taken when a fault is detected. Such functions help to preserve productivity and operational effectiveness of integral components.



Applicable EMI / EMC Standards

Product Standard:

Products	Electromagnetic Compatibility
Phase Sequence	IEC60947-5-1
Voltage Protection	IEC60947-2
Current Protection	IEC60947-1
Earth Leakage Current	IEC60947-2

Category	Standards Compliance	
ESD Immunity	IEC 61000-4-2	Level III
Surge Immunity	IEC 61000-4-5	+/- 2 kV common mode, +/- 1 kV differential mode
Radiated Susceptibility	IEC 61000-4-3	Level III, 80 to 1000MHz Level II, 1.4GHz to 2GHz Level I, 2GHz to 2.7GHz
Conducted Susceptibility	IEC 61000-4-6	Level III
Voltage Dips and Interruptions	IEC 61000-4-11	Dips: 0% residual voltage / 1 cycle (Criteria B.), 40% residual voltage / 10 cycles 50 Hz / 12 cycles 60 Hz (Criteria C) 70% residual voltage / 25 cycles 50 Hz / 30 cycles 60 Hz (Criteria C) Interruptions: 0% residual voltage / 250 cycles 50 Hz / 300 cycles 60 Hz (Criteria C)
Conducted Emission	CISPR-11	
Radiated Emission	CISPR-11	
Electrical Fast Transient	IEC 61000-4-4	Level III

FEATURES

- 3Ø - 3 Wire Input
- Self Powered
- Monitors Under Voltage, Over Voltage, Phase Sequence and Phase Failure
- Trip time delay (T); 0.2 to 10 sec
- Slim, Space Saving Design
- DIN Rail Mount
- Size: 17.5mm (width)



CAT. NO.

600VPR

Display LED Indication	Relay ON, Power ON
Supply Specification Input Voltage	Self Powered 170-290V AC
Input Specification Input Measurement	Under Voltage/ Over Voltage / Phase Failure / Phase Sequence
Trip Setting	Under Voltage: 170-224V AC / Over Voltage: 236-290V AC
Trip Delay	0.2 - 10 sec
Output Specification Main Output	SPDT - 1 C/O - NO: 5A, NC: 3A@250V AC
Functional Specification Trip Time Settings	Power ON Delay: 0.4 sec / Trip Time Delay: 0.2-10 sec
Reset	Auto reset on removal of fault condition
Power Consumption	20VA max
Accuracy Trip Voltage	+/- 5% of Full Scale
Trip Time	+/-5% of Full Scale
Environmental Specification Operating Temperature	0 to 50°C (32 to 122°F)
Storage Temperature	-20 to 75°C (-4 to 167°F)
Humidity (Non-Condensing)	95% Relative Humidity
Weight	62 grams (.13lbs)

Ordering Information

Part No.	Supply Voltage	CE	RoHS	UL US
600VPR-170/290-CU	170 to 290V AC	●	●	●

LED Indication Chart

Supply	Relay LED	Power LED
Nominal Condition	ON	ON
Phase Reversed	OFF	ON
UV / OV	OFF	ON

DIMENSIONS

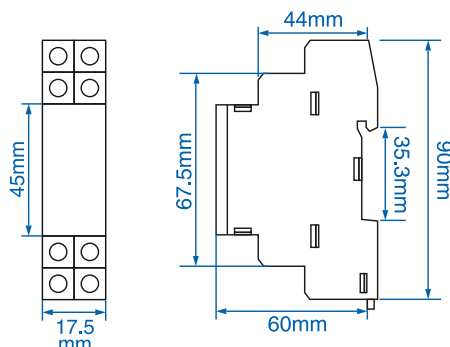

TERMINAL CONNECTIONS

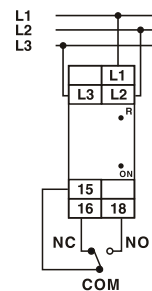

! See pages 42-43 for timing diagrams.

PROTECTION

Analog 3Ø Self Powered Phase Protection Relay LED Indication

PROTECTION

FEATURES

- 3Ø - 3 Wire Input
- Self Powered
- Monitors Phase Sequence, Phase Failure, Phase Imbalance
- Slim, Space Saving Design
- DIN Rail Mount
- Size: 17.5mm (width)



CAT. NO.

600PSR

Display	
LED Indication	Relay ON
Supply Specification	
Input Voltage	Self Powered 165-300V AC
Input Specification	
Input Measurement	Phase failure and Phase Sequence / Phase Imbalance
Trip Setting	Phase Failure Trip: 3 Phase voltage < 154V AC / Phase Imbalance: 30V fixed / Phase Sequence: Yes
Trip Delay	0.2 sec max
Output Specification	
Main Output	SPDT - 1 C/O - NO: 5A / NC: 3A@250V AC
Functional Specification	
Trip Time Settings	Power ON Delay: 0.4 sec / Trip Time Delay: 0.2-10 sec
Hysteresis	6V
Reset	Auto reset on removal of fault condition
Power Consumption	20VA max
Accuracy	
Trip Voltage	+/-3% of Full Scale
Environmental Specification	
Operating Temperature	0 to 50°C (32 to 122°F)
Storage Temperature	-20 to 75°C (-4 to 167°F)
Humidity (Non-Condensing)	95% Relative Humidity
Weight	62 grams (.13lbs)

Ordering Information

Part No.	Supply Voltage	CE	RoHS	cULus
600PSR-165/300-CU	165 to 300V AC	●	●	●

LED Indication Chart

Supply	Relay LED
Nominal Condition	ON
Phase Reversed	OFF
Phase Imbalance	OFF
Phase Failure	OFF

DIMENSIONS

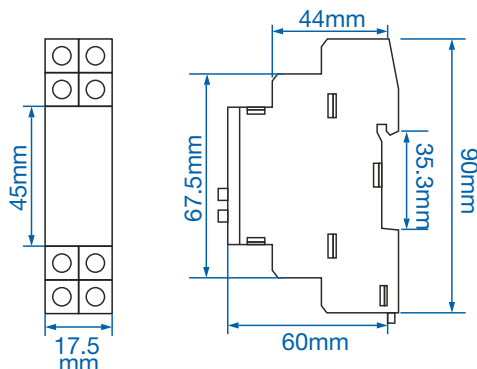

TERMINAL CONNECTIONS

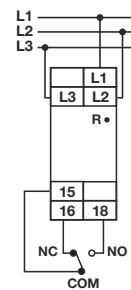

See pages 42-43 for timing diagrams.

FEATURES

- 1Ø - 2 Wire, 3Ø - 3 Wire, 3Ø - 4 Wire Input
- Current leakage / ground fault monitoring, 10mA - 30A
- True RMS measurement
- CBCT connection monitoring
- Power ON delay, Trip time delay and Recovery time delay
- Adjustable switching hysteresis
- Two separate alarm relays with NO or NC operation selectable
- Test and Reset buttons via front / remote
- LCD with backlight
- DIN Rail Mount
- Size: 35mm (Width)



CAT. NO.

900ELR-2

Display	
Display Type	Liquid Crystal Display with backlight
Digits	1 row of 3 digits
Resolution	Current: 0.1mA / 1mA / 0.01A, 0.1A
LED Indication	LED 1: Alarm, LED 2: Pre-Alarm
Supply Specification	
Input Voltage	110/230 V AC (45-65Hz)
Input specification	
Input Measurement	Current Leakage (Via CBCT)
Trip Setting	Leakage Current: 10mA-30A / Pre-Alarm: 50-100% of Leakage Current Setting
Current Rating	Measuring Range (RMS Value) 10mA - 30A, 45-65Hz
Output Specification	
Main Output	SPDT -2 C/O - NO: 5A, 250 V AC and NC:3A, 250 V AC
Functional Specification	
Trip Time Settings	Power ON Delay: 0.5-99.9 sec / Trip Time Delay: 0-99.9 sec / Recovery Time Delay: 0-99.9 sec / Response Time: <30ms (if trip current 5x set value) / <50ms (if trip current 1x set value)
Alarm Indications	Pre-warning alarm, Trip, CBCT error
Hysteresis	5-40% of set value
Latching	Selectable
Reset	Auto/Manual (Selectable)
Power Consumption	3VA max
Electrical Connection	1Ø-2 wire / 3Ø-3 wire / 3Ø- 4 wire
Accuracy	
Current	+/-5% of setting
Power Delay	+/-5% of setting + 100ms
Environmental Specification	
Operating Temperature	0 to 50°C (32 to 122°F)
Storage Temperature	-20 to 70°C (-4 to 158°F)
Humidity (Non-Condensing)	95% Relative Humidity
Weight	217 grams(.48 lbs)
Protection Level	IP50 (for faceplate), IP30 (for housing), IP20 (for terminals)

Ordering Information

Part No.	Supply Voltage	CE	RoHS	UL US
900ELR-2-230V-CE	230V AC	●	●	
900ELR-2-110V	110V AC			

Used with CBCT

See page 14.

DIMENSIONS

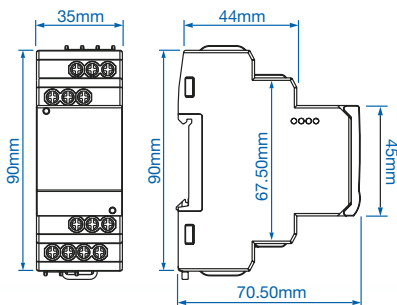

TERMINAL CONNECTIONS

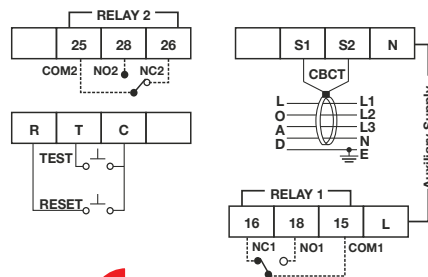

See pages 42-43 for timing diagrams.

PROTECTION

Digital 3Ø Self Powered Voltage / Phase / Frequency Protection Relay Liquid Crystal Display

PROTECTION

FEATURES

- 3Ø - 3 Wire, 3Ø - 4 Wire Input
- Self powered
- Monitors Under voltage, Over voltage, Under frequency, Over frequency, Phase asymmetry, Phase failure and Phase sequence
- True RMS measurement
- Power ON delay, Trip time delay and Recovery time delay
- Adjustable switching Hysteresis
- Two separate alarm relays
- LCD
- Din Rail mount
- Size : 35mm (Width)



CAT. NO.

900VPR-2

Display	
Display Type	Liquid Crystal Display
Digits	1 row of 3 digits
LED Indication	LED 1: Power On, LED 2: Relay 1, LED 3: Relay 2
Supply Specification	
Input Voltage	Self Powered 280-520 V AC
Input Specification	
Input Measurement	Under Voltage / Over Voltage / Under Frequency / Over Frequency / Phase Asymmetry / Phase Failure / Phase Sequence
Trip Setting	Under Voltage: 280- 520 V AC [L-L] (3Ø-3 wire) 160-300 V AC [L-N] (3Ø-4 wire), Over Voltage: 280-520 V AC [L-L] (3Ø-3 wire) 160-300 V AC [L-N](3Ø-4 wire), Under Frequency: 45-65Hz / Over Frequency: 45-65Hz / Phase Failure: Yes / Phase Sequence: Yes / Phase Asymmetry: 5-99.9%
Measuring Range	280 - 520V AC [L-L]; 160 - 300V AC [L-N]
Output Specification	
Main Output	SPDT -2 C/O - NO: 5A, 250 V AC and NC:3A, 250 V AC
Functional Specification	
Trip Time Settings	Power ON Delay: 2-99.9 sec / Trip Time Delay: 0-99.9 sec / Recovery Time Delay: 0-99.9 sec / Response Time: <200ms
Alarm Indications	Trip
Hysteresis	Current: 0.1-99.9A
Latching	Selectable
Reset	Auto/Manual (Selectable)
Electrical Connection	3Ø-3 wire, 3Ø- 4 wire
Accuracy	
Voltage	+/-1%
Frequency	+/-0.3 Hz
Time Setting	+/- 5% of setting, +/-200ms
Environmental Specification	
Operating Temperature	0 to 55°C (32 to 131°F)
Storage Temperature	-20 to 70°C (-4 to 158°F)
Humidity (Non-Condensing)	95% Relative Humidity
Weight	135 grams (.31 lbs)
Protection Level	IP50 (for faceplate), IP30 (for housing), IP20 (for terminals)

Ordering Information

Part No.	Supply Voltage	CE	RoHS	cULus
900VPR-2-280/520V-CU	280-520V AC	●	●	●

DIMENSIONS

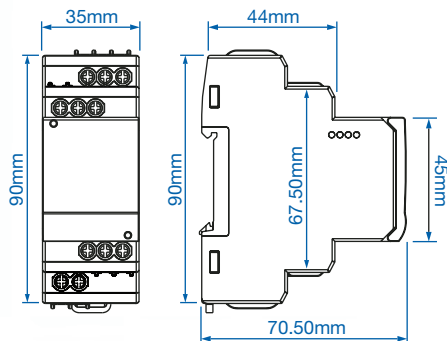

TERMINAL CONNECTIONS

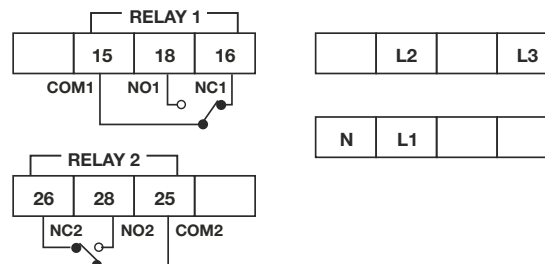

See pages 42-43 for timing diagrams.

FEATURES

- 3Ø - 3 Wire, 3Ø - 4 Wire Input
- Monitors Under voltage, Over voltage, Under frequency, Over frequency, Phase asymmetry, Phase failure, Phase sequence and Neutral Loss
- True RMS measurement
- Power ON delay, Trip time delay and Recovery time delay
- Adjustable switching hysteresis
- Two alarm relay with NC or NO operation selectable
- LCD with backlight
- DIN Rail Mount
- Size: 35mm (Width)



CAT. NO.

900VPR-BL-U

Display	
Display Type	liquid Crystal Display with backlight
Digits	1 row of 3 digits
LED Indication	LED 1: Relay 1, LED 2: Relay 2
Supply Specification	
Input Voltage	85-270 V AC/DC
Input Specification	
Input Measurement	Under Voltage / Over Voltage / Under Frequency / Over Frequency / Phase Asymmetry / Phase Failure / Neutral Loss and Phase Sequence
Trip Setting	Under Voltage: 85-500 V AC [L-L] (3Ø-3 wire) 50-288 V AC [L-N] (3Ø-4 wire), Over Voltage: 85-500 V AC [L-L] (3Ø-3 wire), 50-288 V AC [L-N](3Ø-4 wire), Under Frequency: 45-65Hz, Over Frequency: 45-65Hz / Phase Failure: Yes / Phase Sequence: Yes / Phase Asymmetry: 5-30% / Neutral Loss: Yes
Output Specification	
Main Output	SPDT -2 C/O - NO: 5A, 250 V AC and NC:3A, 250 V AC
Functional Specification	
Trip Time Settings	Power ON Delay: 0.5-300 sec / Trip Time Delay: 0-300 sec / Recovery Time Delay: 0-300 sec / Response Time: <120ms
Alarm Indications	Trip
Hysteresis	Voltage: 1-40 V / Frequency: 0.1-2 Hz / Asymmetry: 2-20%
Latching	Selectable
Reset	Auto/Manual (Selectable)
Electrical Connection	3Ø-3 wire, 3Ø- 4 wire
Accuracy	
Voltage	1V
Frequency	0.1 Hz
Time Setting	+/- 5% of setting, + 200ms
Environmental Specification	
Operating Temperature	-25 to 55°C (-13 to 131°F)
Storage Temperature	-25 to 70°C (-13 to 158°F)
Humidity (Non-Condensing)	95% Relative Humidity
Weight	150 grams (.33 lbs)
Protection Level	IP50 (for faceplate), IP30 (for housing), IP20 (for terminals)

Ordering Information

Part No.	Supply Voltage	CE	RoHS	UL
900VPR-1-BL-U-CE	85-270V AC/DC	●	●	

DIMENSIONS

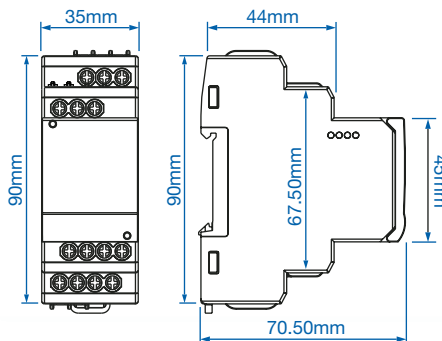

TERMINAL CONNECTIONS

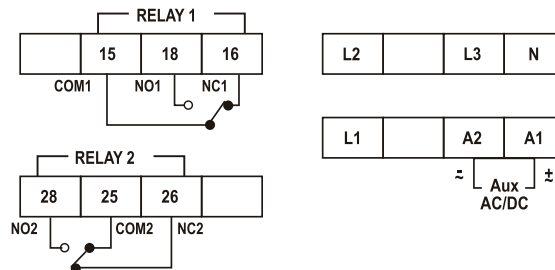

See pages 42-43 for timing diagrams.

PROTECTION

Digital 1Ø Current Protection Relay Backlit Liquid Crystal Display

FEATURES

- 1Ø - 2 Wire Input
- Monitors Under current and Over current
- True RMS measurement
- Power ON delay, Trip time delay and Recovery time delay
- Adjustable switching hysteresis
- Two alarm relay with NC or NO operation selectable
- LCD with backlight
- DIN Rail Mount
- Size: 35mm (Width)



CAT. NO.

900CPR-1-BL-U

Display	
Display Type	liquid Crystal Display with backlight
Digits	1 row of 3 digits
Resolution	Current: 0.01 / 0.1 / 1A / 0.01kA
LED Indication	LED 1: Relay 1, LED 2: Relay 2
Supply Specification	
Input Voltage	85-270 V AC (50-60Hz)
Input Specification	
Input Measurement	Current Transformer-Under Current / Over Current
CT Setting	CT: Primary 1A/5A - 999A / CT secondary 1A/5A (Selectable)
Trip Setting	Under Current: 0-999A / Over Current: 0.5-1.19kA
Current Rating	Measuring Range (RMS Value) 0-1.19kA
Output Specification	
Main Output	SPDT -2 C/O - NO: 5A, 250 V AC and NC:3A, 250 V AC
Functional Specification	
Trip Time Settings	Power ON Delay: 0.5-99.9 sec / Trip Time Delay: 0-99.9 sec / Recovery Time Delay: 0-99.9 sec / Response Time: <200ms
Alarm Indications	Trip
Hysteresis	Current: 0.1-99.9A
Latching	Selectable
Reset	Auto/Manual (Selectable)
Power Consumption	4VA max
Electrical Connection	1Ø-2 wire
Accuracy	
Current	+/- 1% of setting, +/- 2 digits
Time Setting	+/- 5% of setting, +/- 100ms
Environmental Specification	
Operating Temperature	0 to 50°C (32 to 122°F)
Storage Temperature	-20 to 70°C (-4 to 158°F)
Humidity (Non-Condensing)	95% Relative Humidity
Weight	150 grams (.33 lbs)
Protection Level	IP50 (for faceplate), IP30 (for housing), IP20 (for terminals)

Ordering Information

Part No.	Supply Voltage	CE	RoHS	cULus
900CPR-1-BL-U-CE	85-270V AC	●	●	

Used with SPCT

See page 12.

DIMENSIONS

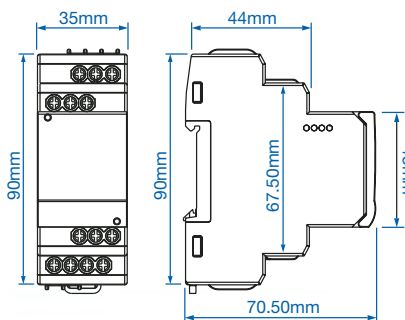

TERMINAL CONNECTIONS

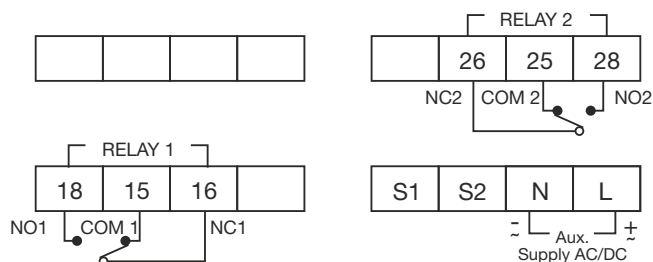

See pages 42-43 for timing diagrams.

PROTECTION

FEATURES

- 3Ø - 3 Wire, 3Ø - 4 Wire, 1Ø - 2 Wire Input
- Monitors Under current, Over current and Current asymmetry
- True RMS measurement
- Power ON delay, Trip time delay and Recovery time delay
- Adjustable switching hysteresis
- One alarm relay with NC or NO operation selectable
- LCD with backlight
- DIN Rail Mount
- Size: 35mm (Width)



CAT. NO.

900CPR-3-1-BL

Display	
Display Type	Liquid Crystal Display with backlight
Digits	1 row of 3 digits
Resolution	Current: 0.01 / 0.1 / 1A / 0.01kA
LED Indication	LED 1: Power On, LED 2: Relay
Supply Specification	
Input Voltage	230 V AC +/- 15% (45-65Hz) / 110 V AC +/- 15% (45-65Hz)
Input Specification	
Input Measurement	Current Transformer-Under Current / Over Current / Current Asymmetry
CT Setting	CT: Primary 1A/5A - 999A / CT secondary 1A/5A (Selectable)
Trip Setting	Under Current: 0-999A / Over Current: 0.5-1.19kA / Current Asymmetry: 5.0 - 99.9%
Current Rating	Measuring Range (RMS Value) 0-1.19kA
Output Specification	
Main Output	SPDT - 1 C/O - NO: 5A, 250 V AC and NC:3A, 250 V AC
Functional Specification	
Trip Time Settings	Power ON Delay: 0.5-99.9 sec / Trip Time Delay: 0-99.9 sec / Recovery Time Delay: 0-99.9 sec / Response Time: <200ms
Alarm Indications	Trip
Hysteresis	Current: 0.1-99.9A
Latching	Selectable
Reset	Auto/Manual (Selectable)
Power Consumption	12VA max
Electrical Connection	1Ø-2 wire, 3Ø-3 wire, 3Ø- 4 wire
Accuracy	
Current	+/- 1% of setting, +/- 2 digits
Time Setting	+/- 5% of setting, +/- 200ms
Environmental Specification	
Operating Temperature	0 to 50°C (32 to 122°F)
Storage Temperature	-20 to 70°C (-4 to 158°F)
Humidity (Non-Condensing)	95% Relative Humidity
Weight	146 grams (.32 lbs)
Protection Level	IP50 (for faceplate), IP30 (for housing), IP20 (for terminals)

Ordering Information

Part No.	Supply Voltage	CE	RoHS	cUL US
900CPR-3-1-BL-230V-CE	230V AC	●	●	
900CPR-3-1-BL-110V-CE	110V AC	●	●	

Used with SPCT

See page 12.

DIMENSIONS

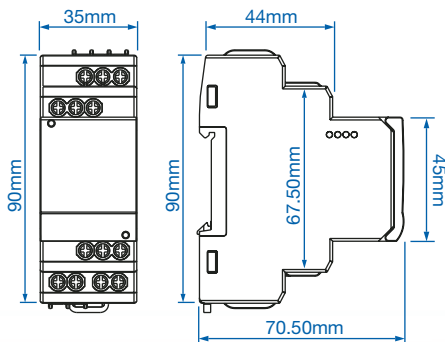

TERMINAL CONNECTIONS

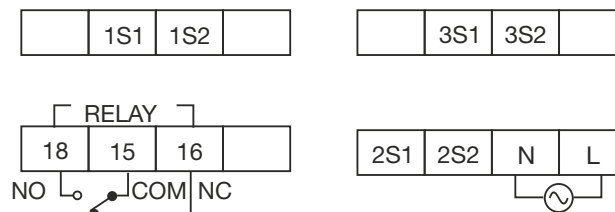

See pages 42-43 for timing diagrams.

PROTECTION

FEATURES

- Use with Different Bus Bar
- Panel Mount / Din Rail Mount (Optional Accessory)
- Accuracy: Class 0.5 to 5



CAT. NO.

SPCT

Input Specification	
Rated Primary Rating	30A-4000A
Rated secondary Rating	5A
Technical Specification	
Rated Burden	1 VA-15 VA
Class of Accuracy	0.5-5
Thermal Nominal Continuous	120% of In Rated Current (I _{cth})
Thermal Short Circuit Current (LTH)	I _{lth} =60 X I _n for 1 sec.
Instrument security Factor	FS < 5
Isolation Class	E (120°C max)
Max Operating Voltage (Um)	720 V maximum
Isolation Test Voltage	3 kV AC (1 min.)
Nominal Rated Frequency	AC 50Hz-60Hz
Environmental Specification	
Operating Temperature	0 to 50°C (32 to 122°F)
Storage Temperature	-5 to 50°C (23 to 122°F)
Humidity (Non-Condensing)	95% Relative Humidity

Ordering Information

Part No.	Wire Aperture (mm)	Current Ratio	Burden in VA	Accuracy Class
SPCT 62/22 30/5 A VA 1 CL 5	DIA 22	30/5	1	5
SPCT 62/30 50/5 A VA 1 CL 3	30x10	50/5	1	3
SPCT 62/30 50/5 A VA 1.5 CL 3	30x10	50/5	1.5	3
SPCT 62/30 75/5 A VA 1 CL 3	30x10	75/5	1	3
SPCT 62/30-75/5 A VA 3 CL 3	30x10	75/5	3	3
SPCT 62/30 100/5 A VA 1 CL 1	30x10	100/5	1	1
SPCT 62/40 100/5 A VA 1 CL 1	30x10	100/5	3	1
SPCT 62/30 100/5 A VA 3 CL 1	40x10	100/5	1	1
SPCT 62/40 125/5 A VA 1 CL 1	40x10	125/5	1	1
SPCT 62/40 150/5 A VA 1.5 CL 1	40x10	150/5	1.5	1
SPCT 62/40 150/5 A VA 3 CL 1	40x10	150/5	3	1
SPCT 62/40 160/5 A VA 1.5 CL 1	40x10	160/5	1.5	1
SPCT 62/40 200/5 A VA 2.5 CL 0.5	40x10	200/5	2.5	0.5
SPCT 62/40 200/5 A VA 3 CL 1	40x10	200/5	3	1
SPCT 62/40 250/5 A VA 2.5 CL 0.5	40x10	250/5	2.5	0.5
SPCT 62/40 250/5 A VA 3 CL 1	40x10	250/5	3	1
SPCT 62/40 300/5 A VA 3 CL 0.5	40x10	300/5	3	0.5
SPCT 62/40 400/5 A VA 3.75 CL 0.5	40x10	400/5	3.75	0.5
SPCT 62/40 400/5 A VA 5 CL 1	40x10	400/5	5	1
SPCT 100/60 500/5 A VA 5 CL 1	60x12	500/5	5	1
SPCT 100/60 600/5 A VA 5 CL 0.5	60x12	600/5	5	0.5
SPCT 100/60 600/5 A VA 7.5 CL 1	60x12	600/5	7.5	1
SPCT 100/60 800/5 A VA 10 CL 0.5	60x12	800/5	10	0.5
SPCT 100/60 1000/5 A VA 15 CL 0.5	60x12	1000/5	15	0.5
SPCT 100/60 1200/5 A VA 15 CL 0.5	60x12	1200/5	15	0.5
SPCT 140/100 800/5 A VA 15 CL 0.5	100x30	800/5	15	0.5
SPCT 140/100 1000/5 A VA 15 CL 0.5	100x30	1000/5	15	0.5
SPCT 140/100 1200/5 A VA 15 CL 0.5	100x30	1200/5	15	0.5
SPCT 140/100 1250/5 A VA 15 CL 0.5	100x30	1250/5	15	0.5
SPCT 140/100 1500/5 A VA 15 CL 0.5	100x30	1500/5	15	0.5
SPCT 140/100 1600/5 A VA 15 CL 0.5	100x30	1600/5	15	0.5
SPCT 140/100 2000/5 A VA 15 CL 0.5	100x30	2000/5	15	0.5
SPCT 140/100 2500/5 A VA 15 CL 0.5	100x30	2500/5	15	0.5
SPCT 140/100 3000/5 A VA 15 CL 0.5	100x30	3000/5	15	0.5
SPCT 140/100 3500/5 A VA 15 CL 0.5	100x30	3500/5	15	0.5
SPCT 140/100 4000/5 A VA 15 CL 0.5	100x30	4000/5	15	0.5

Used with CPR modules. See pages 10-11.

DIMENSIONS

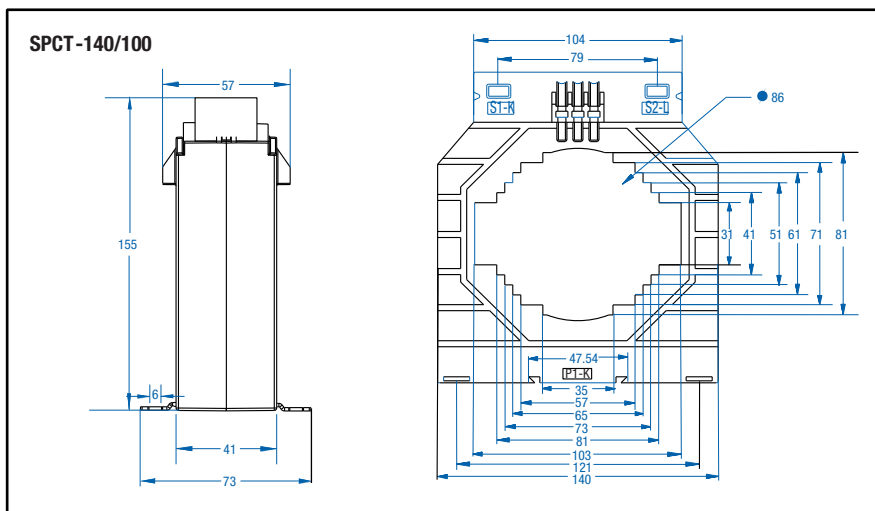
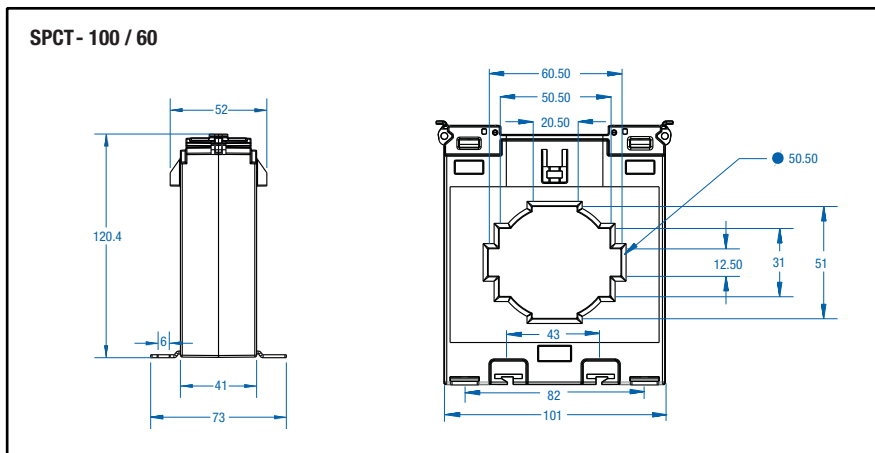
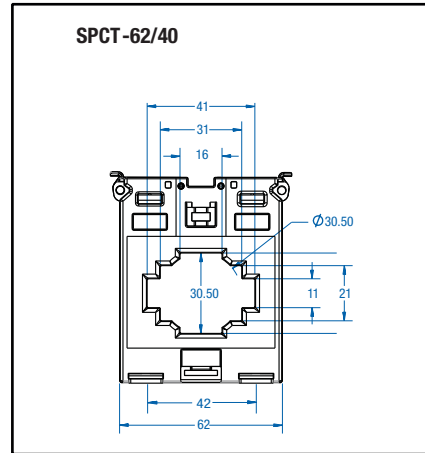
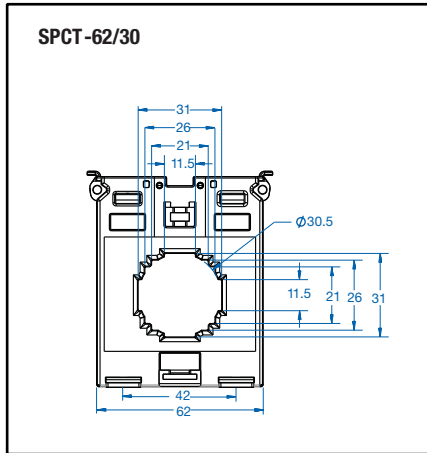

PROTECTION

Used with CPR modules. See pages 10-11.

Closed Toroid for Current Leakage Protection

FEATURES

- Compact
- Reliable and Accurate
- Flexible Design



CAT. NO.

CBCT

Input Specification	
Current Transformer Type	Closed Toroid
Turns Ratio	1000:1
Rated Current	30A
Depth	
CBCT-35-1	2.5mm
CBCT-70-1	2.5mm
CBCT-120-1	2.5mm
CBCT-210-1	2.5mm
CBCT-310-1	2.5mm
Mechanical Specification	
Wire Size (max)	0.2-1.5mm ² (AWG: 24-14)
Screw Tightening Torque	0.5 N-M
Humidity (Non-Condensing)	95% Relative Humidity
Environmental Specification	
Operating Temperature	0 to 55°C (32 to 131°F)
Storage Temperature	-20 to 75°C (-4 to 167°F)
Humidity (Non-Condensing)	95% Relative Humidity

Ordering Information

Part No.	Inner Diameter	Turns Ratio
CBCT - 35-1	35mm	1000:1
CBCT - 70-1	70mm	1000:1
CBCT - 120-1	120mm	1000:1
CBCT - 210-1	210mm	1000:1
CBCT - 310-1	310mm	1000:1

DIMENSIONS

CBCT Type	D	d	H	W	W1
CBCT-35-1	64	45	96	13	52.5
CBCT-70-1	98	82	131	13	87
CBCT-120-1	149	125	184	13	122
CBCT-210-1	268	210	270	25	55
CBCT-310-1	377	310	380	25	65
Std. Tol.	2-3	5-6	-	1.5-2	-

CT Type ZPG (Zero Phase Current)

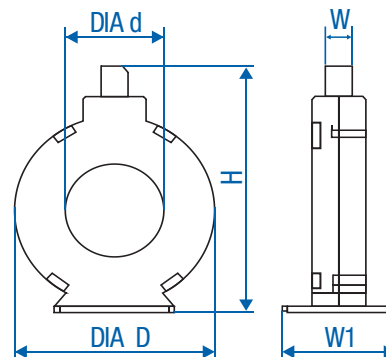

Used with ELR module. See page 7.

Control

Altech is pleased to offer a variety of process control equipment comprised of:

- Temperature Controllers
- Process Indicators
- Counters
- Rate Indicators

These components are designed to take inputs from a variety of sources and allow for the precise controlling of functions in an eased manner.



Applicable EMI / EMC Standards

Product Standard: IEC 61326-1

Products	Electromagnetic Compatibility	
Category		Standards Compliance
ESD Immunity	IEC 61000-4-2	Level III
Surge Immunity	IEC 61000-4-5	+/- 2 kV common mode, +/- 1 kV differential mode
Radiated Susceptibility	IEC 61000-4-3	Level III, 80 to 1000MHz Level II, 1.4GHz to 2GHz Level I, 2GHz to 2.7GHz
Conducted Susceptibility	IEC 61000-4-6	Level II
Voltage Dips and Interruptions	IEC 61000-4-11	Dips: 0% residual voltage / 1 cycle (Criteria B.), 40% residual voltage / 10 cycles 50 Hz / 12 cycles 60 Hz (Criteria C) 70% residual voltage / 25 cycles 50 Hz / 30 cycles 60 Hz (Criteria C) Interruptions: 0% residual voltage / 250 cycles 50 Hz / 300 cycles 60 Hz (Criteria C)
Conducted Emission	CISPR-11	
Radiated Emission	CISPR-11	
Electrical Fast Transient	IEC 61000-4-4	Level II

Single Display, 1 Output Temperature Controllers 7 Segment LED Display

FEATURES

- 3 digits, 7 segment LED single display
- TC / RTD Inputs
- PID, ON-OFF Control
- Single Setpoint
- °C / °F
- Field selectable Control Output (Relay or SSR)



TC513AX

48 x 48 mm

TC203AX

72 x 72 mm

TC303AX

96 x 96mm

CAT. NO.

Display	
Display Type	7 Segment LED Display
Digits	1 row of 3 digits
Resolution	Fixed 1 Degree
Supply Specification	
	85-270 V AC/DC (50/60Hz)
Input Specification	
Input Measurement	Thermocouple (J,K,T,R,S) / RTD (Pt100)
Sampling Time	0.25 sec
Input Filter (FTC)	0.2 to 10.0 sec
Output Specification	
Main Output	Selectable- SPDT- 10A @250V AC / 30V DC, resistive OR SSR Drive 12V DC, 50mA
Auxiliary Output	-
Functional Specification	
Control Action	1) PID Control with Auto Tuning 2) ON-OFF Control
PID	Proportional Band (P): 0-400° Integral Time (I): 0-99.9 sec Derivative Time (D): 0-999 sec
Alarm Mode	-
Hysteresis	0.1-99.9°
Temperature Unit	°C / °F
Cycle Time	0.1 to 99.9 sec.
Manual Reset Value	-19.9° to 19.9°
Power Consumption	5VA max @230V AC1
Set Points	1
Accuracy	
J, K,T INPUTS*	0.25% of Full Scale ±1°
R, S INPUTS*	0.5% of Full Scale ±2°
RTD INPUT	0.1% of Full Scale ±1°
Environmental Specification	
Operating Temperature	0 to 50°C (32 to 122°F)
Storage Temperature	-20 to 75°C (-4 to 167°F)
Humidity (Non-Condensing)	95% Relative Humidity
Weight	See dimensions on next page

Ordering Information

Part No.	Control Output	Supply Voltage	CE	RoHS	UL US
TC513AX-CU	10A Relay or 12V DC SSR	85 - 270V AC/DC	●	●	●
TC203AX-CU	10A Relay or 12V DC SSR	85 - 270V AC/DC	●	●	●
TC303AX-CU	10A Relay or 12V DC SSR	85 - 270V AC/DC	●	●	●

Mounting Accessories (supplied with units)

For TC513 : 48 X 48 Collar clamp ACL4802

For TC203/TC303 : Clamp side with screw assembled

DIMENSIONS

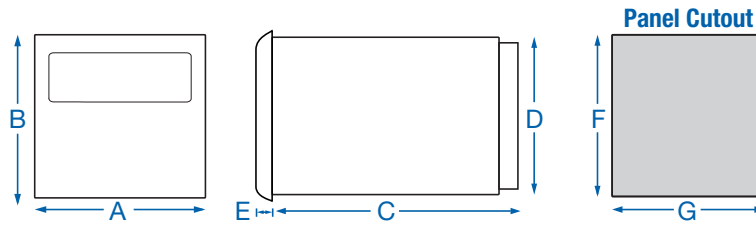

	A	B	C	D	E	F	G	Weight
TC513AX	52	52	94	45	4	46	46	129 grams (.3 lbs)
TC203AX	72	72	83.7	67	4.5	69	69	180 grams (.4lbs)
TC303AX	96	96	73	90.5	5	92	92	240 grams (.52lbs)

TERMINAL CONNECTIONS

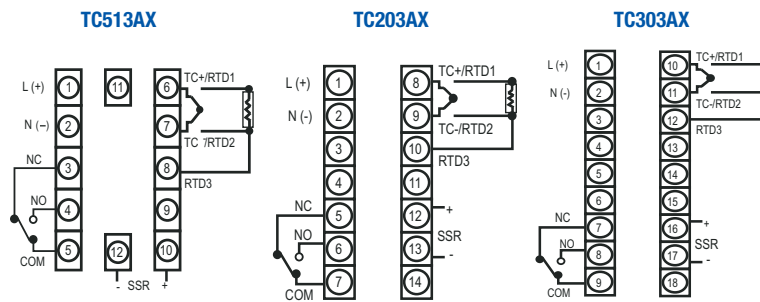

Note : NC Contact Valid for TC303AX

Input Sensor Ranges

Sensor Type	Resolution	Ranges 1
Pt100	°C	-150 to 850
	°F	-199 to 999
J	°C	-199 to 750
	°F	-199 to 999
K	°C	-199 to 999
	°F	-199 to 999
T	°C	-199 to 400
	°F	-199 to 750
R and S	°C	0 to 999
	°F	32 to 999

Accessories (Optional)

Standard SELEC accessories that can be used with this product.

Adapter plate

- 1) AP7248: Plastic adapter plate, used to mount 1/16 DIN (cutout size 48 x 48); Instrument into existing (72 x 72) cutout size.
- 2) AP9648: Plastic adapter plate, used to mount 1/16 DIN (cutout size 48 x 48); Instrument into existing (96 x 96) cutout size.
- 3) AP9672: Plastic adapter plate, used to mount 72 x72mm size instrument into existing (96 x 96) cutout size.
- 4) AP4896-4848-G-C: Plastic adapter plate, used to mount 1/16 DIN (cutout size 48 x 48) Instrument into existing (48 x 96) cutout size.

Dual Display, 1 Output Temperature Controllers 7 Segment LED Display

FEATURES

- Dual Display, 3 digit, 7 segment LED
- TC/RTD Inputs
- PID, ON-OFF Control
- Single Setpoint
- °C / °F
- Field selectable Control Output (Relay or SSR)
- Easy to use
- Size: 48mm x 48mm



CAT. NO.

TC533AX

Display	
Display Type	7 Segment LED Display
Digits	2 rows of 3 digits
Resolution	1 Degree
Supply Specification	
	85 to 270 V AC/DC (50/60Hz)
Input Specification	
Input Measurement	Thermocouple (J,K,T,R,S) / RTD (Pt100)
Sampling Time	0.25 sec
Input Filter (FTC)	0.2 to 10.0 sec
Output Specification	
Main Output	Selectable- SPDT- 10A @250V AC / 30V DC, resistive OR SSR Drive - 12V DC, 50mA
Auxillary Output	
Functional Specification	
Control Action	1) PID Control with Auto Tuning 2) ON-OFF Control
PID	Proportional Band (P): 0-400° Integral Time (I): 0-999 sec Derivative Time (D): 0-200 sec
Alarm Mode	-
Hysteresis	0.1-99.9°
Temperature Unit	°C / °F
Cycle Time	0.1 to 99.9 sec.
Manual Reset Value	-19.9° to 19.9°
Power Consumption	5VA max @230V AC
Set Points	1
Accuracy	
J, K, T INPUTS*	0.25% of F.S. ±1°
R, S INPUTS*	0.5% of F.S. ±2°
RTD INPUT	0.1% of F.S. ±1°
Environmental Specification	
Operating Temperature	0 to 50°C (32 to 122°F)
Storage Temperature	-20 to 75°C (-4 to 167°F)
Humidity (Non-Condensing)	95% Relative Humidity
Weight	129 grams (.3 lbs)

Ordering Information

Part No.	Output	Supply Voltage	CE	RoHS	UL US
TC533AX-CU	Relay 10A, 12V DC SSR	85-270V AC/DC	●	●	●

Mounting Accessories (supplied with units)

For TC533 : 48 X 48 Collar clamp ACL4802

DIMENSIONS

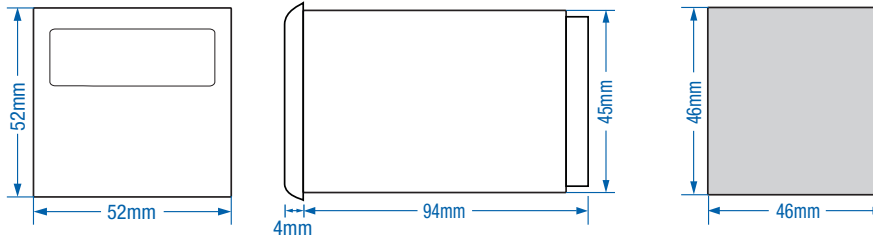

TERMINAL CONNECTIONS

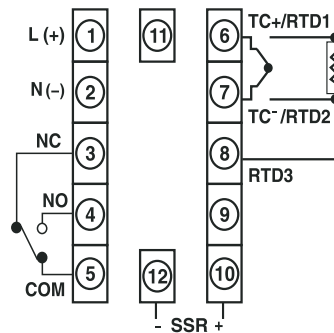

Input Sensor Ranges

Sensor Type	Resolution	Ranges 1
Pt100	°C	-150 to 850
	°F	-199 to 999
J	°C	-199 to 750
	°F	-199 to 999
K	°C	-199 to 999
	°F	-199 to 999
T	°C	-199 to 400
	°F	-199 to 750
R and S	°C	0 to 999
	°F	32 to 999

Accessories (Optional)

Standard SELEC accessories that can be used w1th this product.

Adapter plate

1) AP7248: Plastic adapter plate, used to mount 1/16 DIN (cutout size 48 x 48); Instrument into existing (72 x 72) cutout size.

2) AP9648: Plastic adapter plate, used to mount 1/16 DIN (cutout size 48 x 48); Instrument into existing (96 x 96) cutout size.

3) AP4896-4848-G-C:

Plastic adapter plate, used to mount 1/16 DIN; (cutout size 48 x 48) Instrument into existing (48 x 96) cutout size.

Dual Display, 2 Output Temperature Controllers 7 Segment LED Display

FEATURES

- Dual Display, 4 digits, 7 segment LED
- TC/RTD Inputs
- PID, ON-OFF Control
- Dual Setpoint
- °C / °F
- Field selectable Control Output (Relay or SSR)
- Additional Aux. Output
- Easy to use



TC544A
48 x 48 mm

TC244AX
72 x 72 mm

TC344AX
96 x 96mm

CAT. NO.

Display	
Display Type	7 Segment LED Display
Digits	2 rows of 4 digits
Resolution	1/0.1 Degree for TC/RTD / Fixed 1 Degree for R and S TC
Supply Specification	
	85-270V AC/DC (50/60Hz)
Input Specification	
Input Measurement	Thermocouple (J,K,T,R,S) / RTD (Pt100)
Sampling Time	0.25 sec
Input Filter (FTC)	0.2 to 10.0 sec
Output Specification	
Main Output	Selectable- SPDT- 5A @250V AC / 30V DC, resistive OR SSR Drive - 12V DC, 50mA
Auxiliary Output	SPDT- 5A @250V AC / 30V DC, resistive (TC544A: SPST Relay)
Functional Specification	
Control Action	1) PID Control with Auto Tuning 2) ON-OFF Control
PID	Proportional Band (P): 0-400° Integral Time (I): 0-9999 sec Derivative Time (D): 0-9999 sec
Alarm Mode	Deviation / Absolute
Hysteresis	0.1-99.9°
Temperature Unit	°C / °F
Cycle Time	0.1 to 99.9 sec.
Manual Reset Value	-19.9° to 19.9°
Power Consumption	5VA max @230V AC
Set Points	2
Accuracy	
J, K, T INPUTS*	0.25% of F.S. ±1°
R, S INPUTS*	0.5% of F.S. ±2°
RTD INPUT	0.1% of F.S. ±1°
Environmental Specification	
Operating Temperature	0 to 50°C (32 to 122°F)
Storage Temperature	-20 to 70°C (-4 to 158°F)
Humidity (Non-Condensing)	95% Relative Humidity
Weight	See dimensions on next page

Ordering Information

Part No.	Control Output	Auxiliary Output	Supply Voltage	CE	RoHS	UL US
TC544A-CU	10A Relay or 12V DC SSR	5A Relay	85 - 270V AC/DC	●	●	●
TC244AX-CU	10A Relay or 12V DC SSR	5A Relay	85 - 270V AC/DC	●	●	●
TC344AX-CU	10A Relay or 12V DC SSR	5A Relay	85 - 270V AC/DC	●	●	●
TC544A-1-CU	10A Relay or 12V DC SSR	SSR	85 - 270V AC/DC	●	●	●

Mounting Accessories (supplied with units)

For TC544 : 48 X 48 Collar clamp ACL4802

For TC244/TC344 : Clamp side with screw assembled

DIMENSIONS

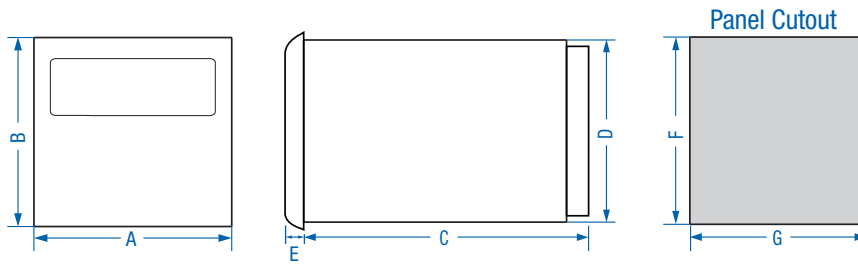

	A	B	C	D	E	F	G	Weight
TC544AX	52	52	94	45	4	46	46	142 grams (.31 lbs)
TC244AX	72	72	83.7	67	4.5	69	69	200 grams (.44 lbs)
TC344AX	96	96	73	90.5	5	92	92	252 grams (.33 lbs)

TERMINAL CONNECTIONS

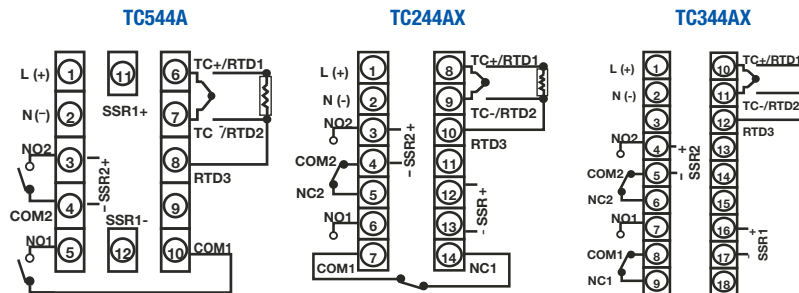

Input Sensor Ranges

Sensor Type	Resolution	Ranges	
		1	0.1
Pt100	°C	-150 to 850	-150 to 850
	°F	-238 to 1562	-199 to 999
J	°C	-199 to 750	-199 to 750
	°F	-328 to 1382	-199 to 999
K	°C	-199 to 1350	-199 to 999
	°F	-328 to 2462	-199 to 999
T	°C	-199 to 400	-199 to 400
	°F	-328 to 750	-199 to 750
R and S	°C	0 to 1750	NA
	°F	32 to 3182	NA

Accessories (Optional)

Standard SELEC accessories that can be used with this product.

Adapter plate

- 1) AP7248: Plastic adapter plate, used to mount 1/16 DIN (cutout size 48 x 48); Instrument into existing (72 x 72) cutout size.
- 2) AP9648: Plastic adapter plate, used to mount 1/16 DIN (cutout size 48 x 48); Instrument into existing (96 x 96) cutout size.
- 3) AP9672: Plastic adapter plate, used to mount 72 x72mm size instrument into existing (96 x 96) cutout size.
- 4) AP4896-4848-G-C: Plastic adapter plate, used to mount 1/16 DIN (cutout size 48 x 48) Instrument into existing (48 x 96) cutout size.

Advanced Dual Display, 3 Outputs Temperature Controllers 7 Segment LED Display

FEATURES

- 4 + 4 digits , 7 segment LED dual display
- TC / RTD Input, Analog input
- ON-OFF, PID
- Heat Cool PID
- °C / °F
- Ramp Soak
- Soft Start
- RS485 Communication (PID500 only)



CAT. NO.	PID500	PID110	PID330
Display			
Display Type	7 Segment LED Display		
Digits	2 rows of 4 digits		
Resolution	1/0.1 Degree for TC/RTD / Fixed 1 Degree for R, S & T / Decimal point position selectable 1/0.1/0.01/0.001 for analog input		
Supply Specification			
Input Voltage	85-270V AC/DC (50/60Hz)		
Input Specification			
Input Measurement	Thermocouple (J,K,T,R,S,C,E,B,N,L,U,W, Platine II) / RTD (Pt100)	Signal Inputs (-5 to 56mV, 0 to 10V, 0 to 20mA)	
Sampling Time	200msec		
Input Filter (FTC)	1 to 99 sec		
Output Specification			
Main Output	Selectable- SPST- 10A @230V AC / 30V DC, resistive OR SSR Drive(Voltage Pulse)- 12V DC, 50mA OR Current- 4-20mA DC		
Auxiliary Output	2 Selectable- SPST- 5A @230V AC / 30V DC, resistive OR SSR Drive(Voltage Pulse)- 12V DC, 20mA		
Retransmission	4 to 20mA DC, 0-10V DC (100msec. Update Rate)		
Functional Specification			
Control Action	1) PID Control with Auto Tuning 2) ON-OFF Control		
PID	Proportional Band (P): 1-400 Integral Time (I): 0-3600sec Derivative Time (D): 0-200sec		
Alarm Modes	Deviation High/Low, Absolute High/Low, Band, Sensor Break PID330- Full Scale High, Full Scale Low		
Hysteresis	0.1-99.9		
Temperature Unit	°C / °F		
Cycle Time	0.1 to 100 sec.		
Manual Reset Value	-99.9 to 19.9		
Power Consumption	5VA max @230V AC		
Set Points	2		
Accuracy			
TC INPUTS	0.25% of F.S. ±1		
R, S INPUTS	0.5% of F.S. ±2		
RTD INPUT	0.1% of F.S. ±1		
Environmental Specification			
Operating Temperature	0 to 50 C (32 to 122 F)		
Storage Temperature	-20 to 75 C (-4 to 167 F)		
Humidity (Non-Condensing)	85% Relative Humidity		
Weight	See dimensions on next page		

Ordering Information

Part No.	Output 1	Output 2	Output 3		Supply Voltage	CE	RoHS	UL US
			Relay/SSR	RS485				
PID500-0-0-01-CU	Relay	Relay	Relay	—	85-270V AC/DC	●	●	●
PID500-1-0-01-CU	SSR	Relay	Relay	—	85-270V AC/DC	●	●	●
PID500-0-0-04-CU	Relay	Relay	Relay	Yes	85-270V AC/DC	●	●	●
PID500-1-0-04-CU	SSR	Relay	Relay	Yes	85-270V AC/DC	●	●	●
PID500-1-1-04-CU	SSR	SSR	Relay	Yes	85-270V AC/DC	●	●	●
PID500-2-0-04-CU	4-20mA	Relay	Relay	Yes	85-270V AC/DC	●	●	●
PID500-3-0-04-CU	0-10V	Relay	Relay	Yes	85-270V AC/DC	●	●	●
PID110-0-0-01-CU	Relay	Relay	Relay	—	85-270V AC/DC	●	●	●
PID110-1-0-01-CU	SSR	Relay	Relay	—	85-270V AC/DC	●	●	●
PID330-0-0-01-CU	Relay	Relay	Relay	—	85-270V AC/DC	●	●	●
PID330-1-0-01-CU	SSR	Relay	Relay	—	85-270V AC/DC	●	●	●

Mounting Accessories (supplied with units)

For PID500: 48 X 48 Collar clamp ACL4802

For PID110 and PID330: Clamp side with screw assembled

PID500

DIMENSIONS

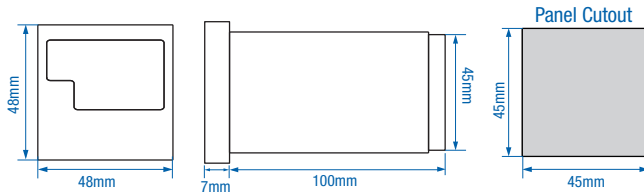

Weight: 95 grams (.43 lbs)

Serial Communication

Interface standard	RS485
Communication address	1 to 99, maximum of 32 units per line
Transmission mode	Half duplex
Transmission protocol	MODBUS RTU
Transmission distance	500 m maximum
Transmission speed	9600, 4800, 2400, 1200, 600, 300 bits / sec
Parity	Non, Odd, even, Mark, Space
Stop bits	1 or 2
Response Time	100 ms (Max and independent of baud rate)

TERMINAL CONNECTIONS

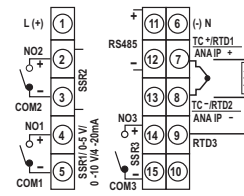

Accessories (Optional)

Standard SELEC accessories that can be used with this product.

Adapter plate

- 1) AP7248: Plastic adapter plate, used to mount 1/16 DIN (cutout size 48 x 48); Instrument into existing (72 x 72) cutout size.
- 2) AP9648: Plastic adapter plate, used to mount 1/16 DIN (cutout size 48 x 48); Instrument into existing (96 x 96) cutout size.
- 3) AP4896-4848-G-C: Plastic adapter plate, used to mount 1/16 DIN (cutout size 48 x 48) Instrument into existing (48 x 96) cutout size.

PID110

DIMENSIONS

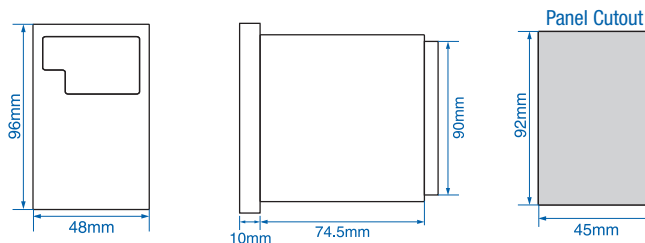

Weight: 250 grams (.55 lbs)

TERMINAL CONNECTIONS

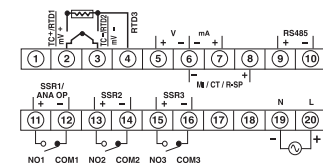

PID5330

DIMENSIONS

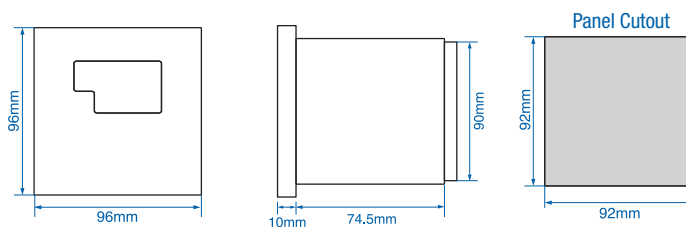

Weight: 295 grams (.65 lbs)

TERMINAL CONNECTIONS

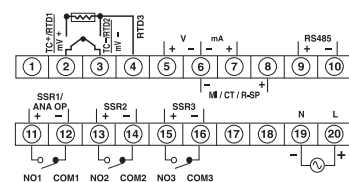

Cooling Controller 7 Segment LED Display

FEATURES

- 3 Digit 7, Segment LED
- °C / °F
- Defrost Management
- High and Low Temperature Alarm
- Up to 20A Relay Output
- Compact Size
- Easy to use
- Size: 36mm x 72mm



CAT. NO.

CH403

Display	
Display Type	7 Segment LED Display
Digits	1 row of 3 digits
Resolution	1/0.1 Degree for NTC
LED Indication	Set point lock / Defrost / Relay ON / Alarm
Supply Specification	
Input Voltage	85-270V AC/DC (50/60Hz)
Input specification	
Input Measurement	NTC probe
Thermistor Range	-40 to 100° C
Output Specification	
Main Output	SPDT - 10A @ 230V AC, resistive Optional- SPST - 20A @ 230V AC, resistive (no alarm)
Optional Alarm Output	SPST - 5A @ 230V AC, resistive OR SSR Drive - 12V DC, 10mA
Functional Specification	
Control Action	On-Off
Mode	Heat and Cool
Alarm Modes	High alarm, Low Alarm
Hysteresis	0.1-9.9°
Temperature Unit	°C / °F
Defrost Time / Frequency	Programmable from 0-99min , 0-99 sec/min/hr
Restart Time Delay	Adjustable 0-99min
Power Consumption	5VA max @230V AC
Setpoints	1
Accuracy	
NTC Input	0.25% of Full Scale ±1°C
Environmental Specification	
Operating Temperature	0 to 50°C (32 to 122°F)
Storage Temperature	-20 to 75°C (-4 to 167°F)
Humidity (Non-Condensing)	95% Relative Humidity
Weight	110 grams (.242 lbs)

Ordering Information

Part No.	Control Output	Alarm Output	Supply Voltage	CE	RoHS	UL
CH403-1-NTC-CU	10A Relay	12V DC SSR	85-270V AC/DC	●	●	●
CH403-2-NTC-CU	20A Relay	-	85-270V AC/DC	●	●	●
CH403-3-NTC-CU	10A Relay	5A Relay	85-270V AC/DC	●	●	●

Accessory (also available separately on request)

Model	Sensor Type	Temperature Range	Nominal Resistance
TSP04	NTC probe	-40 to +100 °C	10 K ohms @ 25°C



Sensor Provided with Product

NTC Sensor	TSP04
------------	-------

DIMENSIONS

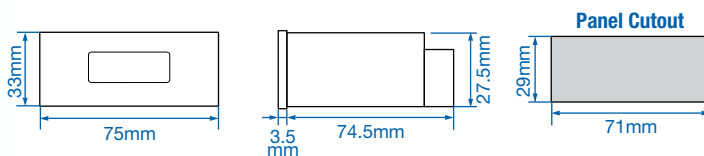

TERMINAL CONNECTIONS

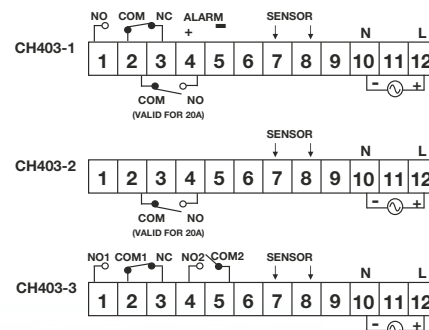

FEATURES

- 4 Digit 7 Segment LED
- TC / RTD / Analog Inputs
- °C / °F
- 24V DC Sensor Supply



CAT. NO.

PIC101N

Display	
Display Type	7 Segment LED Display
Digits	1 row of 4 digits
Resolution	1/0.1 Degree for TC/RTD only. Decimal point position selectable 1/0.1/0.01/0.001 for analog input
LED Indication	-
Supply Specification	
Input Voltage	85-270V AC/DC (50/60Hz)
Input Specification	
Input Measurement	Thermocouple (J,K,T,R,S) RTD (Pt100) DC Analog Inputs (-5 to 56mV, 0 to 10V, 0/4 to 20mA)
Output Specification	
Sensor Supply	24V DC, 30mA
Functional Specification	
Temperature Unit	°C / °F
Power Consumption	5VA max @230V AC
Accuracy	
TC INPUTS	.25% of Full Scale ±1°
R, S INPUTS	.5% of Full Scale ±2°
RTD INPUT	.1% of Full Scale ±1°
ANALOG INPUT	'+/- .5% of Full Scale, +/- 1 digit
Environmental Specification	
Operating Temperature	0 to 50°C (32 to 122°F)
Storage Temperature	-20 to 75°C (-4 to 167°F)
Humidity (Non-Condensing)	95% Relative Humidity
Weight	200 grams (44 lbs)

Ordering Information

Part No.	Supply Voltage	CE	RoHS	UL US
PIC101N-CU	85-270V AC/DC	●	●	●

Mounting Accessories (supplied with units)

Clamp side with screw assembled

DIMENSIONS

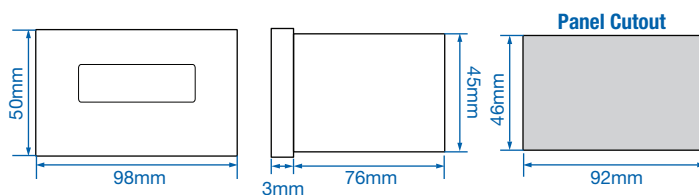

TERMINAL CONNECTIONS

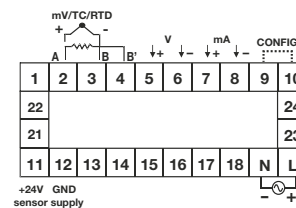

Advanced Process Indicator 7 Segment LED Display

FEATURES

- 4 Digit 7 Segment LED
- TC / RTD / Analog Inputs
- °C / °F
- 2 Alarm Outputs
- 24V DC Sensor Supply
- Optional Features
- Retransmission Output



CAT. NO.

PIC152N

Display	
Display Type	7 Segment LED Display
Digits	1 row of 4 digits
Resolution	1/0.1 Degree for TC/RTD only. Decimal point position selectable 1/0.1/0.01/0.001 for analog input
LED Indication	LED 1: Alarm On
Supply Specification	
Input Voltage	85-270V AC/DC (50/60Hz)
Input specification	
Input Measurement	Thermocouple (J,K,T,R,S) RTD (Pt100) DC Analog Inputs (-5 to 56mV, 0 to 10V, 0/4 to 20mA)
Output Specification	
Main Output	SPDT- 5A @ 250V AC/ 24V DC, resistive
Auxiliary Output	Retransmission (Optional) 4 to 20mA DC, 0-10V DC
Sensor Supply	-
Functional Specification	
Alarm Modes	High Alarm / Low Alarm / Ban / Fail output / Fault Diagnosis
Temperature Unit	0.1-99.9°
Temperature Unit	°C / °F
Rest	Auto or Latched
Power Consumption	6VA max @230V AC
Annunciator	Programmable
Accuracy	
TC INPUTS	.25% of Full Scale ±1°
R, S INPUTS	.5% of Full Scale ±2°
RTD INPUT	.1% of Full Scale ±1°
ANALOG INPUT	'+/- .5% of Full Scale, +/- 1 digit
Environmental Specification	
Operating Temperature	0 to 50°C (32 to 122°F)
Storage Temperature	-20 to 75°C (-4 to 167°F)
Humidity (Non-Condensing)	95% Relative Humidity
Weight	240 grams (.52lbs)

Ordering Information

Part No.	Main Output	Retransmission Output	Supply Voltage	CE	UL	UL
PIC152N-A-CU	2x5A Relay	-	85-270V AC/DC	●	●	●
PIC152N-B-2-CU	2x5A Relay	4-20mA DC	85-270V AC/DC	●	●	●
PIC152N-B-4-CU	2x5A Relay	0-10V DC	85-270V AC/DC	●	●	●

Mounting Accessories (supplied with units)

Clamp side with screw assembled

TERMINAL CONNECTIONS

DIMENSIONS

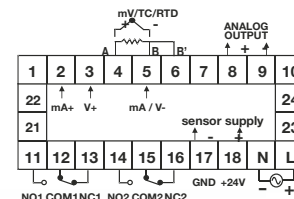
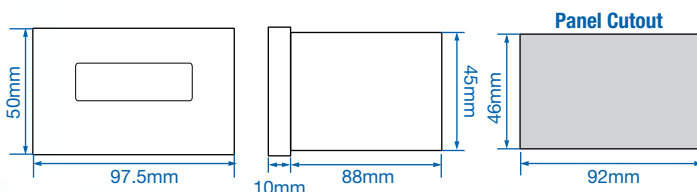

FEATURES

- 6 Digit, 7 Segment LED Counter,
- Compact Size
- Inbuilt Sensor Supply



CAT. NO.

XC410

Display	
Display Type	7 Segment LED Display
Digits	1 row of 6 digits
Supply Specification	
Input Voltage	90-270V AC/DC (50/60Hz)
Input Specification	
Input Measurement	NPN/PNP
Input Type	Voltage Pulse (3-30V DC) from proximity, switches, encoders, solid state devices, potential free contact
Input Speed	A) 0-20Hz B) 0-1kHz
Reset	Front, Remote
Output Specification	
Sensor Supply	Inbuilt, 12V DC, 30mA
Functional Specification	
Range	999999 counts
Time Ranges	-
Counting Direction	Up
Memory	Yes
Configuration Lock	-
Power Consumption	5VA max
Accuracy	
Rate	-
Environmental Specification	
Operating Temperature	0 to 50°C (32 to 122°F)
Storage Temperature	-20 to 75°C (-4 to 167°F)
Humidity (Non-Condensing)	95% Relative Humidity
Weight	110 grams (.242 lbs)

Ordering Information

Part No.	Supply Voltage	CE	RoHS	UL US
XC410-CU	90-270V AC/DC	●	●	●

DIMENSIONS

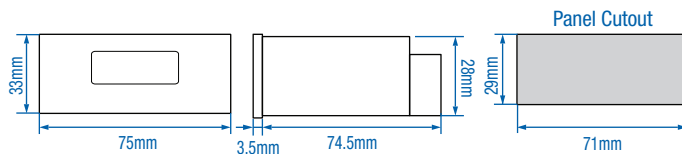

TERMINAL CONNECTIONS

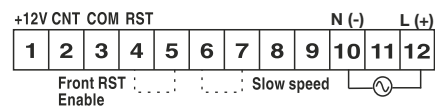

Compact 6 Digit Counter / 5 Digit RPM Indicator 7 Segment LED Display

FEATURES

- 6 Digit, 7 Segment LED Counter, and 5 digit RPM indicator
- Compact Size
- Inbuilt Sensor Supply
- 2 Set Points



CAT. NO.

XC1200

Display	
Display Type	7 Segment LED Display
Digits	1 row of 6 digits
Resolution	1/0.1/0.01/0.001/0.0001 Degree
LED Indication	LED 1: Relay 1, LED 2: Relay 2
Supply Specification	
Input Voltage	85-270V AC/DC (50/60Hz)
Input specification	
Input Measurement	NPN/PNP
Input Type	Voltage Pulse (3-30V DC) from proximity, switches, encoders, solid state devices, potential free contact
Input Speed	A) 0-30Hz B) 0-2.5kHz C) 0-5kHz (for up and down mode only)
Reset	Front (user selectable), Remote
Scale Factor	0.00001-9.99999 X 10 ⁿ , n = -3, -2, -1, 0, 1, 2
Output Specification	
Main Output	DPDT -2 C/O - 5A @ 230V AC / 24 V DC
Sensor Supply	Inbuilt, 12V DC, 30mA
Functional Specification	
Modes	ON Delay / Interval delay /Auto reset / Time pulse repeat
Range	999999 counts
Counting Direction	Up, Down, Bidirectional, Quadrature
Memory	Yes
Power Consumption	5VA max
Accuracy	
Rate	.05% +/- 2 counts
Environmental Specification	
Operating Temperature	0 to 50°C (32 to 122°F)
Storage Temperature	-20 to 75°C (-4 to 167°F)
Humidity (Non-Condensing)	95% Relative Humidity
Weight	230 grams (.507 lbs)

Ordering Information

Part No.	Supply Voltage	CE	RoHS	UL US
XC1200-CU	85-270V AC/DC	●	●	●

DIMENSIONS

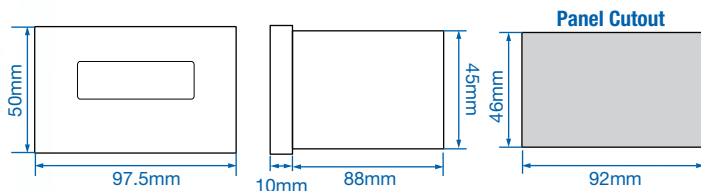

TERMINAL CONNECTIONS

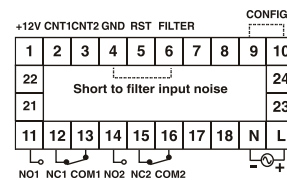

CONTROL

FEATURES

- Dual Display, 4 digit, 7 segment LED
- 2 Setpoints
- Programmable Input Scaling
- Down Counting for Timer, Up / Down Counting for Counter



CAT. NO.

XTC5400

Display	
Display Type	7 Segment LED Display
Digits	2 row of 4 digits
LED Indication	LED 1: Relay 1, LED 2: Relay 2, LED 3: sec., LED 4: Min., LED 5: Hrs.
Supply Specification	
Input Voltage	85-270V AC/DC (50/60Hz)
Input specification	
Input Measurement	NPN/PNP
Input Type	Voltage Pulse (3-30V DC) from proximity, switches, encoders, solid state devices, potential free contact
Input Speed	A) 3Hz, B) 30Hz, C) 5kHz
Reset	Front, Remote/ Power interruption (programmable)
Scale Factor	0.001-999x10 ⁿ , n = -3, -2, -1, 0, 1, 2
Output Specification	
Main Output	2 SPST - 2NO - 5 @ 230V AC
Sensor Supply	Inbuilt, 12V DC, 30mA
Functional Specification	
Modes	Timer : ON delay /Interval /Cyclic On first / Cyclic OFF first / Batch Counter : ON delay /Interval / Auto reset, Time pulse repeat , Batch
Range	-
Time Ranges	0-99.99 sec 0-999.9 sec/min/hr 0-9999 sec/min/hr 0-99:59 min: sec 0-99:59 hr:min
Counter Range	-999 to 9999 counts
Counting Direction	Timer: Down, Counter: Up/Down
Memory	10 years
Configuration Lock	-
Power Consumption	5VA max
Setpoints	2
Accuracy	
Rate	+/- .05% of Full Scale or 50m sec.
Environmental Specification	
Operating Temperature	0 to 50°C (32 to 122°F)
Storage Temperature	-20 to 75°C (-4 to 167°F)
Humidity (Non-Condensing)	95% Relative Humidity
Weight	175 grams (.385 lbs)

Ordering Information

Part No.	Supply Voltage	CE	RoHS	UL US
XTC5400-CU	90-270V AC/DC	●	●	●

DIMENSIONS

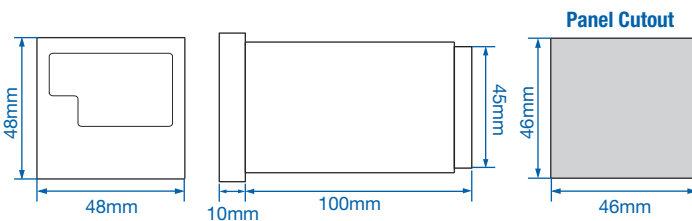

TERMINAL CONNECTIONS

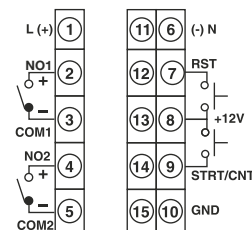

CONTROL

Rate Indicator 7 Segment LED Display

FEATURES

- 6 Digit Counter; 4 Digit Rate Indicator
- Programmable Input Scaling
- Inbuilt Sensor Supply



CAT. NO.

RC102C

Display

Display Type	Liquid Crystal Display with backlight
Digits	1 row of 6 digits
LED Indication	LED 1: Rate, LED 2: Total

Supply Specification

Input Voltage	90-270V AC/DC (50/60Hz)
---------------	-------------------------

Input Specification

Input Measurement	PNP
Input Type	Voltage Pulse (3-30V DC) from proximity, switches, encoders, solid state devices, potential free contact
Input Speed	A) 0-30Hz B) 0-2.5kHz
Reset	Front. Remote
Scale Factor	0.00001-9.99999 X 10 ⁿ , n = -3, -2, -1, 0, 1, 2

Output Specification

Sensor Supply	Inbuilt, 12V DC, 30mA
---------------	-----------------------

Functional Specification

Modes	Unidirectional
Range	Count: 9999.99, 99999.9, 999999 (user selectable) Rate: 4.00 - 9999 RPM
Counting Direction	Up
Memory	Current count value: 1 year, Parameter setting: 10 years
Power Consumption	5VA max

Accuracy

Rate	.05% +/- 2 counts
------	-------------------

Environmental Specification

Operating Temperature	0 to 50°C (32 to 122°F)
Storage Temperature	-20 to 75°C (-4 to 167°F)
Humidity (Non-Condensing)	95% Relative Humidity
Weight	200 grams (44lbs)

Ordering Information

Part No.	Supply Voltage	CE	RoHS	UL
RC102C-CU	90-270V AC/DC	●	●	●

DIMENSIONS

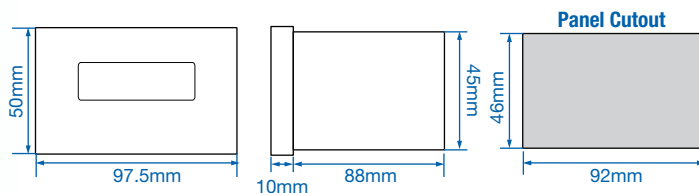

TERMINAL CONNECTIONS

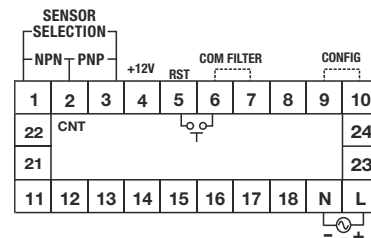

TIMING

Altech is pleased to offer a variety of timing equipment comprised of:

- DIN Mounted Timers
- Panel Mounted Timers
- Digital Timers

These components cover a vast range of timing functions from the most basic of settings to the most advanced.



Applicable EMI / EMC Standards

Product Standard: IEC 61326-1

Products

Electromagnetic Compatibility

Category		Standards Compliance
ESD Immunity	IEC 61000-4-2	Level II for Contact discharge Level III for Air discharge
Surge Immunity	IEC 61000-4-5	+/- 2 kV common mode,
Radiated Susceptibility	IEC 61000-4-3	Level III, 80 to 1000MHz Level II, 1.4GHz to 2GHz Level I, 2GHz to 2.7GHz
Conducted Susceptibility	IEC 61000-4-6	Level II
Radiated Emission	CISPR-11	
Electrical Fast Transient	IEC 61000-4-4	Level II

Multifunction Digital Timer Panel Mount

FEATURES

- Multifunction - 7 Timing Functions
- 9 Time Ranges, Seconds/Minutes/Hours
- Dual Display, 4 Digit, 7 segment LED
- 2 Setpoints



c **UL** US **CE**
E253771

CAT. NO.

XT5042

Display	
Display Type	7 Segment LED Display
Digits	2 row of 4 digits
LED Indication	LED 1: Relay 1, LED 2: Relay 2, LED 3: Sec., LED 4: Min., LED 5: Hrs.
Supply Specification	
Input Voltage	85-270V AC/DC (50/60Hz)
Input Specification	
Start Input	Gate / Pulse start (programmable)
Reset	Front, remote, power interruption (programmable)
Output Specification	
Main Output	2 SPST - 2NO - 5 @ 230V AC
Functional Specification	
Modes	ON delay / Interval / Cyclic ON first / Cyclic OFF first / Forward-pause-reverse / Instantaneous+delayed batch
Time Ranges	0-99.99 sec / 0-999.9 sec/min/hr / 0-9999 sec/min/hr / 0-99:59 min: sec / 0-99:59 hr:min
Counting Direction	Up/Down
Memory	10 years
Power Consumption	5VA max
Set Point	2
Accuracy	
Timer	+/- .05% of Full Scale or 50m sec.
Environmental Specification	
Operating Temperature	0 to 50°C (32 to 122°F)
Storage Temperature	-20 to 75°C (-4 to 167°F)
Humidity (Non-Condensing)	95% Relative Humidity
Weight	175 grams (.385 lbs)
Protection Level	IP65 (for faceplate)

Ordering Information

Part No.	Supply Voltage	CE	RoHS	c UL US
XT5042-CU	85 to 270V AC/DC	●	●	●

DIMENSIONS

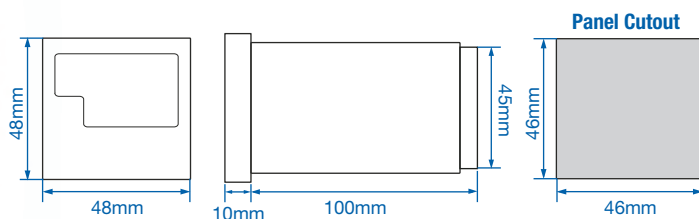

TERMINAL CONNECTIONS

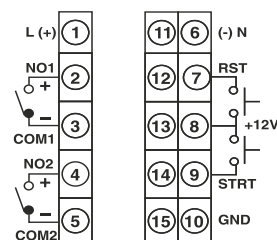

See pages 42-43 for timing diagrams.

FEATURES

- ON Delay / Interval
- 12 Time Ranges, Seconds/Minutes/Hours
- Universal Supply Voltage
- Compact Size
- Size: 1/16 DIN 48mm x 48mm
- Panel Mount / Plug-in Timer



CAT. NO.

55XU

Display	
Display Type	Analog Timer
Digits	N/A
Resolution	Analog
LED Indication	LED 1: Power On, LED 2: Relay On
Supply Specification	
Input Voltage	20-240V AC (50/60Hz) and 12-240V DC
Input Specification	
Reset	On interruption of power; Reset time <100m sec
Output Specification	
Main Output	DPDT - 2 C/O - 5A @ 230V AC / 24 V DC, resistive
Functional Specification	
Modes	ON delay/interval
Time Ranges	0-1 sec/min/hr / 0-3 sec/min/hr / 0-10 sec/min/hr / 0-30 sec/min/hr
Power Consumption	2VA max
Accuracy	
Timer	Setting +/-5% of Full Scale Repeat +/-0.5% or 50m sec.
Environmental Specification	
Operating Temperature	0 to 50°C (32 to 122°F)
Storage Temperature	-20 to 75°C (-4 to 167°F)
Humidity (Non-Condensing)	95% Relative Humidity
Weight	100 grams (.22 lbs)
Protection Level	-

Ordering Information

Part No.	Supply Voltage	Terminal Connection	CE	UL	UL
55XU-P8-CU	20 to 240V AC; 12 to 240V DC	8 Pin*	●	●	●

DIMENSIONS

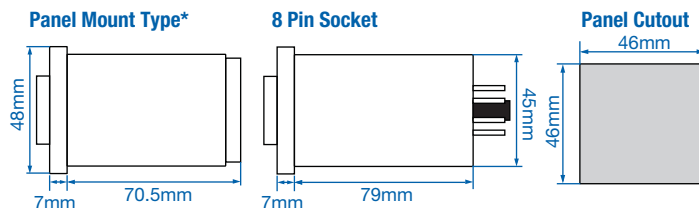

TERMINAL CONNECTIONS*

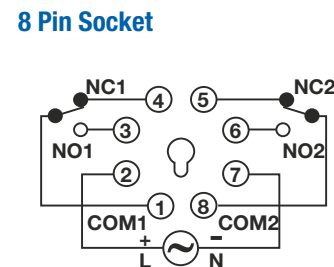

* For screw terminals please contact Altech Corp.



Analog ON-Delay / Interval Timer, SPDT Panel Mount - Plug-in

FEATURES

- ON Delay / Interval
- 8 Time Ranges, Seconds/Minutes
- Dual Supply Voltage
- Compact Size
- Size: 1/16 DIN 48mm x 48mm
- Panel Mount / Plug-in Timer



CAT. NO.

55ES

Display	
Display Type	Analog Timer
Digits	N/A
Resolution	Analog
LED Indication	LED 1: Power On, LED 2: Relay On
Supply Specification	
Input Voltage	230V AC and 24V AC/DC (50/60Hz) OR 110V AC and 24V AC/DC (50/60Hz)
Input Specification	
Reset	On interruption of power; Reset time <100m sec
Output Specification	
Main Output	SPDT -1 C/O - 5A @230V AC / 24 V DC, resistive
Functional Specification	
Modes	ON delay/interval
Time Ranges	0-3 sec/min / 0-10 sec/min / 0-30 sec/min / 0-60 sec/min
Power Consumption	6VA max
Accuracy	
Timer	Setting +/-5% of Full Scale Repeat +/-0.5% or 50m sec.
Environmental Specification	
Operating Temperature	0 to 50°C (32 to 122°F)
Storage Temperature	-20 to 75°C (-4 to 167°F)
Humidity (Non-Condensing)	95% Relative Humidity
Weight	80 grams (.176 lbs)
Protection Level	IP40 (for faceplate)

Ordering Information

Part No.	Supply Voltage	Terminal Connection	CE	RoHS	UL US
55ES-P8-230-CU	230V AC and 24V AC/DC	8 Pin*	●	●	●
55ES-P8-110-CU	110V AC and 24V AC/DC	8 Pin*	●	●	●

DIMENSIONS

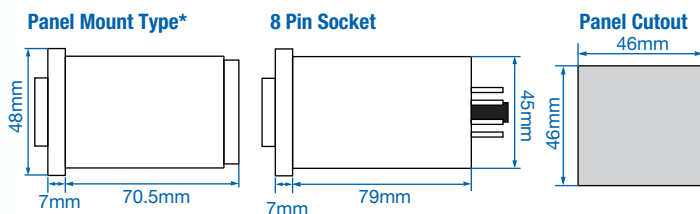

TERMINAL CONNECTIONS*

8 Pin Socket

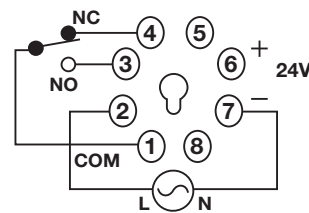

* For screw terminals please contact Altech Corp.



FEATURES

- Cyclic With Unequal ON and OFF Time
- 6 Time Ranges, Seconds/Minutes/Hours
- Universal Supply Voltage
- Compact Size
- Size: 1/16 DIN 48mm x 48mm
- Panel Mount / Plug-in Timer



CAT. NO.

55XC

Display	
Display Type	Analog Timer
Digits	N/A
Resolution	Analog
LED Indication	LED 1: Power On, LED 2: Relay On
Supply Specification	
Input Voltage	20-240V AC (50/60Hz) and 12-240V DC
Input Specification	
Reset	On interruption of power; Reset time <100m sec
Output Specification	
Main Output	DPDT - 2 C/O - 5A @ 230V AC / 24 V DC, resistive
Functional Specification	
Modes	Cyclic ON first or OFF first
Time Ranges	0-1 sec/min/hr (On time) / 0-10 sec/min/hr (ON time) / 0-1 sec/min/hr (OFF time) / 0-10 sec/min/hr (OFF time)
Power Consumption	3VA max
Accuracy	
Timer	Setting +/-5% of Full Scale Repeat +/-0.5% or 50m sec.
Environmental Specification	
Operating Temperature	0 to 50°C (32 to 122°F)
Storage Temperature	-20 to 75°C (-4 to 167°F)
Humidity (Non-Condensing)	95% Relative Humidity
Weight	80 grams (.176 lbs)
Protection Level	-

Ordering Information

Part No.	Supply Voltage	Terminal Connection	CE	RoHS	UL US
55XC-P8-CU	20 to 240V AC; 12 to 240V DC	8 Pin*	●	●	●

DIMENSIONS

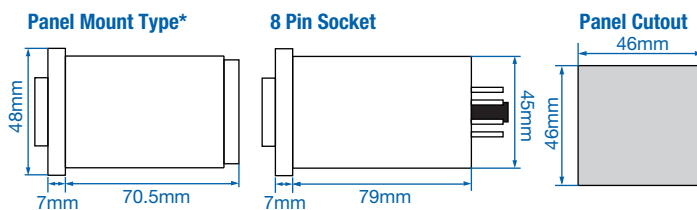

TERMINAL CONNECTIONS*

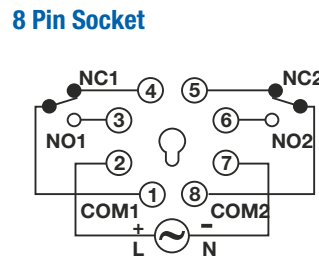

* For screw terminals please contact Altech Corp.

See pages 42-43 for timing diagrams.

FEATURES

- 15 Functions
- 8 Time Ranges, Seconds/Minutes/Hours
- Front Key Pad Setting
- Universal supply voltage
- Slim, Space Saving Design
- DIN Rail Mount
- Size: 17.5 mm (width)



600DT

CAT. NO.

Display	
Display Type	Liquid Crystal Display
Digits	3 rows of 3 digits
Resolution	Decimal point position selectable 1/0.1 sec.
Supply Specification	
Input Voltage	20-240V AC/DC (50/60Hz)
Input specification	
Reset	Front key, on interruption of power; Reset time < 100m sec
Output Specification	
Main Output	SPDT - 1C/O - 8A @ 250V AC
Functional Specification	
Modes	On delay / Interval / Asymmetrical cyclic equal OFF first / Asymmetrical cyclic equal ON first / Cyclic equal OFF first / Cyclic equal ON first / Pulse output / Delay on break / Delay on make/Delay on break / Interval after break / Single shot / Retriggerable single shot / Latching relay / Delay with totalize / Interval with totalize
Time Ranges	0-99.9 sec/min/hr / 0-99.9 sec/min/hr / 0-9:59 min: sec / 0-9:59 hr:min
Counting Direction	Down
Memory	Yes (Selectable)
Power Consumption	4VA max
Accuracy	
TC INPUTS	Setting: +/- 0.1% of set time or +/-50m sec For Y contact operation: +100m sec Repeat +/- 0.1%
Environmental Specification	
Operating Temperature	0 to 50°C (32 to 122°F)
Storage Temperature	-20 to 75°C (-4 to 167°F)
Humidity (Non-Condensing)	95% Relative Humidity
Weight	69 grams (.152 lbs)
Protection Level	IP40 (for casing) IP20 (for terminals)

Ordering Information

Part No.	Supply Voltage	CE	RoHS	cULus
600DT-CU	20-240V AC/DC	●	●	●

DIMENSIONS

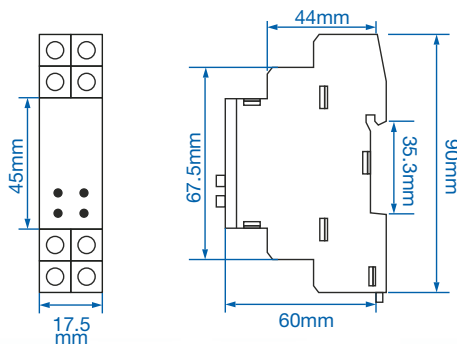

TERMINAL CONNECTIONS

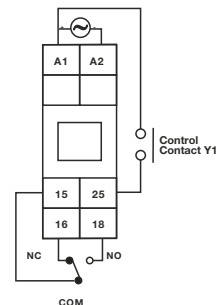

See pages 42-43 for timing diagrams.

FEATURES

- 13 Functions
- 10 Time Ranges, Seconds/Minutes/Hours
- Front knobs for Time Range, Time Scale and Mode Setting
- Slim, Space Saving Design
- DIN Rail Mount
- Size: 17.5mm (width)



CAT. NO.

600XU

Display	
Display Type	Analog Timer
Digits	N/A
LED Indication	LED 1: Power On, LED 2: Relay On
Supply Specification	
Input Voltage	20-240V AC (50/60Hz) and 12-240V DC
Input Specification	
Reset	Reset time <100m sec
Output Specification	
Main Output	SPDT -1C/O - NO/5A, NC/3A@250V AC
Functional Specification	
Modes	On delay / Interval / Cyclic equal OFF first / Cyclic equal ON first / Pulse output, 500m sec fixed / Delay on break / Delay on make / Delay on break / Interval after break / Single shot / Retriggerable single shot / Latching relay / Delay with totalize / Interval with totalize
Time Ranges	0.1 - 1 sec / 0.3 - 3 sec / 1 - 10 sec / 3 - 30 sec 0.1 - 1 min / 0.3 - 3min / 1 -10min / 3 - 30min 0.1 - 1hr / 0.3 - 3hr
Power Consumption	3.2VA max
Accuracy	
Timer	Setting +/-5% of Full Scale Repeat +/-0.5% or 50m sec.
Environmental Specification	
Operating Temperature	0 to 50°C (32 to 122°F)
Storage Temperature	-20 to 75°C (-4 to 167°F)
Humidity (Non-Condensing)	95% Relative Humidity
Weight	64 grams (.141 lbs)
Protection Level	-

Ordering Information

Part No.	Supply Voltage	CE	RoHS	UL US
600XU-A-1-CU	20-240V AC; 12-240V DC	●	●	●

DIMENSIONS

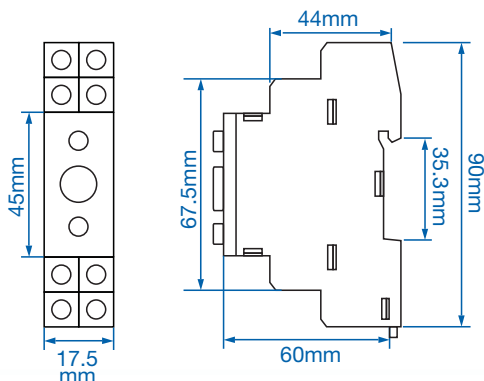

TERMINAL CONNECTIONS

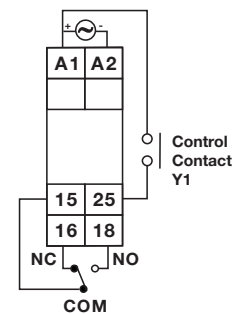

See pages 42-43 for timing diagrams.

Analog Star-Delta Timer 17.5mm DIN Rail

FEATURES

- Star Delta
- 2 Time Ranges
- DIN Rail
- Size: 17.5mm (width)



CAT. NO.

600SD

Display	
Display Type	Analog Timer
Digits	N/A
LED Indication	LED 1: Power On, LED 2: Relay On
Supply Specification	
Input Voltage	230V AC and 110V AC (50/60Hz)
Input Specification	
Reset	On interruption of power; Reset time <100m sec
Output Specification	
Main Output	SPDT -1C/O - Relay each for star and delta
Functional Specification	
Modes	Star-Delta
Time Ranges	3 -30 sec / 6 - 60 sec Pause time: 50/100m sec
Power Consumption	4VA max
Accuracy	
Timer	Setting +/-5% of Full Scale Repeat +/-0.5% or 50m sec. Pause time accuracy: 5% or +/-5m sec
Environmental Specification	
Operating Temperature	0 to 50°C (32 to 122°F)
Storage Temperature	-20 to 75°C (-4 to 167°F)
Humidity (Non-Condensing)	95% Relative Humidity
Weight	73 grams (.163 lbs)
Protection Level	-

Ordering Information

Part No.	Supply Voltage	CE	UL	UL US
600SD-2-230-CU	230V AC	●	●	●
600SD-2-110-CU	110V AC	●	●	●

DIMENSIONS

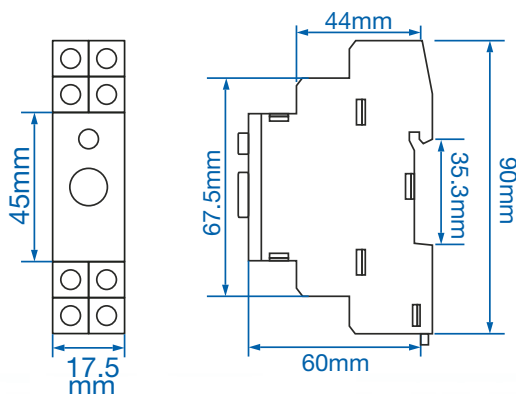

TERMINAL CONNECTIONS

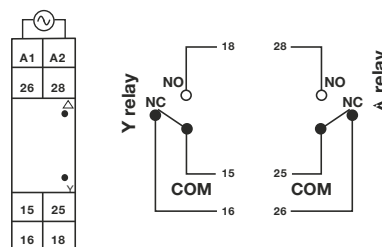

! See pages 42-43 for timing diagrams.

TIMING

FEATURES

- ON Delay / Interval
- 12 Time Ranges, Seconds/Minutes/Hours
- Universal Supply Voltage
- DIN Rail / Back Panel Mount
- Finger Safe Terminals
- Size: 22.5mm (width)



CAT. NO.

800XU

Display	
Display Type	7 Segment LED Display
Digits	N/A
LED Indication	LED 1: Power On, LED 2: Relay On
Supply Specification	
Input Voltage	20-240V AC (50/60Hz) and 12-240V DC
Input specification	
Reset	On interruption of power; Reset time <100m sec
Output Specification	
Main Output	DPDT -2 C/O - 5A @ 230V AC / 24 V DC, resistive
Functional Specification	
Modes	ON delay/interval
Time Ranges	0-1 sec/min/hr / 0-3 sec/min/hr / 0-10 sec/min/hr / 0-30 sec/min/hr
Power Consumption	3.2VA max
Accuracy	
Timer	Setting +/-5% of Full Scale Repeat +/-0.5% or 50m sec.
Environmental Specification	
Operating Temperature	0 to 50°C (32 to 122°F)
Storage Temperature	-20 to 75°C (-4 to 167°F)
Humidity (Non-Condensing)	95% Relative Humidity
Weight	100 grams (.22 lbs)
Protection Level	-

Ordering Information

Part No.	Supply Voltage	CE	RoHS	UL US
800XU-CU	20 - 240V AC; 12 - 240V DC	●	●	●

DIMENSIONS

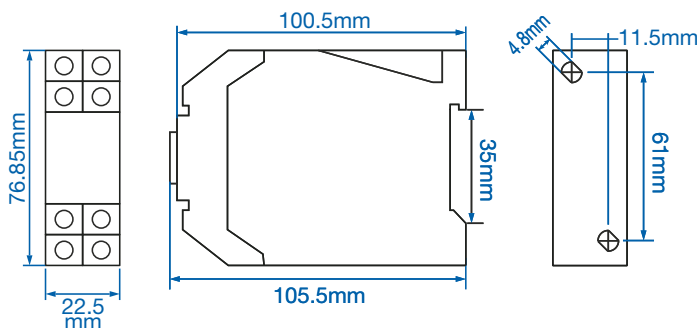

TERMINAL CONNECTIONS

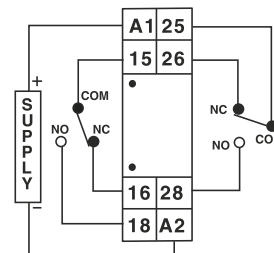

! See pages 42-43 for timing diagrams.

TIMING

Analog Cycle Timer, DPDT 22mm DIN Rail

FEATURES

- Cyclic with Unequal ON and OFF Time
- 6 Time Ranges, Seconds/Minutes/Hours
- Universal Supply Voltage
- DIN Rail / Back Panel Mount
- Finger Safe Terminals
- Size: 22.5mm (width)



CAT. NO.

800XC

Display	
Display Type	7 Segment LED Display
Digits	N/A
LED Indication	LED 1: Power On, LED 2: Relay On
Supply Specification	
Input Voltage	20-240V AC (50/60Hz) and 12-240V DC
Input specification	
Reset	On interruption of power; Reset time <100m sec
Output Specification	
Main Output	DPDT -2 C/O - 5A @ 230V AC / 24 V DC, resistive
Functional Specification	
Modes	Cyclic ON first or OFF first
Time Ranges	0-1 sec/min/hr (On time) / 0-10 sec/min/hr (ON time) / 0-1 sec/min/hr (OFF time) / 0-10 sec/min/hr (OFF time)
Power Consumption	2VA max
Accuracy	
Timer	Setting +/-5% of Full Scale Repeat +/-0.5% or 50m sec.
Environmental Specification	
Operating Temperature	0 to 50°C (32 to 122°F)
Storage Temperature	-20 to 75°C (-4 to 167°F)
Humidity (Non-Condensing)	95% Relative Humidity
Weight	110 grams (.242 lbs)
Protection Level	-

Ordering Information

Part No.	Supply Voltage	CE	RoHS	UL US
800XC-CU	20 - 240V AC; 12 - 240V DC	●	●	●

DIMENSIONS

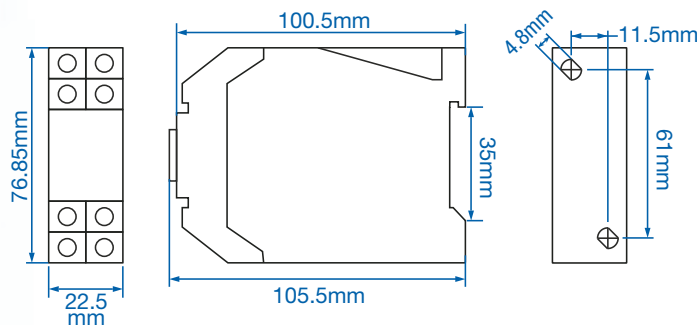

TERMINAL CONNECTIONS

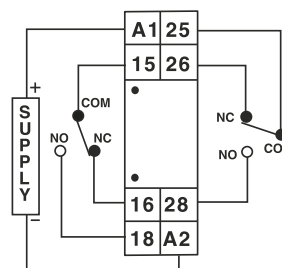

See pages 42-43 for timing diagrams.

TIMING

Part Number	Page
55ES-P8-110-CU.....	34
55ES-P8-230-CU.....	34
55XC-P8-CU.....	35
55XU-P8-CU.....	33
600DT-CU.....	36
600PSR-165/300-CU.....	6
600SD-2-110-CU.....	38
600SD-2-230-CU.....	38
600VPR-170/290-CU.....	5
600XU-A-1-CU.....	37
800XC-CU.....	40
800XU-CU.....	39
900CPR-1-BL-U-CE.....	10
900CPR-3-1-BL-110V-CE.....	11
900CPR-3-1-BL-230V-CE.....	11
900ELR-2-110V.....	7
900ELR-2-230V-CE.....	7
900VPR-1-BL-U-CE.....	9
900VPR-2-280/520V-CU.....	8
CBCT - 120-1.....	14
CBCT - 210-1.....	14
CBCT - 310-1.....	14
CBCT - 35-1.....	14
CBCT - 70-1.....	14
CH403-1-NTC-CU.....	24
CH403-2-NTC-CU.....	24
CH403-3-NTC-CU.....	24
EM368-C-CU.....	44
MA12-100mV-DC-110V-CU.....	44
MA12-110V-CU.....	44
MA12-50mV-DC-110V-CU.....	44
MA2301-110V-CU.....	44
MA501-110V-CU.....	44
MF16-110V-CU.....	44
MFM374-C-CU.....	44
MFM374-CU.....	44
MFM383A-CU.....	44
MFM384-C-CU.....	44
MP14-110V-CU.....	44
MV15-110V-CU.....	44
MV15-DC-200V-110V-CU.....	44
MV15-DC-20V-110V-CU.....	44
MV2307-110V-CU.....	44
MV507-110V-CU.....	44
PIC101N-CU.....	25
PIC152N-A-CU.....	26
PIC152N-B-2-CU.....	26
PIC152N-B-4-CU.....	26
PID110-0-0-01-CU.....	22
PID110-1-0-01-CU.....	22
PID330-0-0-01-CU.....	22
PID330-1-0-01-CU.....	22
PID500-0-0-01-CU.....	22
PID500-0-0-04-CU.....	22
PID500-1-0-01-CU.....	22
PID500-1-0-04-CU.....	22

Part Number	Page
PID500-1-1-04-CU.....	22
PID500-2-0-04-CU.....	22
PID500-3-0-04-CU.....	22
RC102C-CU.....	30
SPCT 100/60 1000/5 A VA 15 CL 0.5.....	12
SPCT 100/60 1200/5 A VA 15 CL 0.5.....	12
SPCT 100/60 500/5 A VA 5 CL 1.....	12
SPCT 100/60 600/5 A VA 5 CL 0.5.....	12
SPCT 100/60 600/5 A VA 7.5 CL 1.....	12
SPCT 100/60 800/5 A VA 10 CL 0.5.....	12
SPCT 140/100 1000/5 A VA 15 CL 0.5.....	12
SPCT 140/100 1200/5 A VA 15 CL 0.5.....	12
SPCT 140/100 1250/5 A VA 15 CL 0.5.....	12
SPCT 140/100 1500/5 A VA 15 CL 0.5.....	12
SPCT 140/100 1600/5 A VA 15 CL 0.5.....	12
SPCT 140/100 2000/5 A VA 15 CL 0.5.....	12
SPCT 140/100 2500/5 A VA 15 CL 0.5.....	12
SPCT 140/100 3000/5 A VA 15 CL 0.5.....	12
SPCT 140/100 3500/5 A VA 15 CL 0.5.....	12
SPCT 140/100 4000/5 A VA 15 CL 0.5.....	12
SPCT 140/100 800/5 A VA 15 CL 0.5.....	12
SPCT 62/22 30/5 A VA 1 CL 5.....	12
SPCT 62/30 100/5 A VA 1 CL 1.....	12
SPCT 62/30 100/5 A VA 3 CL 1.....	12
SPCT 62/30 50/5 A VA 1 CL 3.....	12
SPCT 62/30 50/5 A VA 1.5 CL 3.....	12
SPCT 62/30 75/5 A VA 1 CL 3.....	12
SPCT 62/30-75/5 A VA 3 CL 3.....	12
SPCT 62/40 100/5 A VA 1 CL 1.....	12
SPCT 62/40 125/5 A VA 1 CL 1.....	12
SPCT 62/40 150/5 A VA 1.5 CL 1.....	12
SPCT 62/40 150/5 A VA 3 CL 1.....	12
SPCT 62/40 160/5 A VA 1.5 CL 1.....	12
SPCT 62/40 200/5 A VA 2.5 CL 0.5.....	12
SPCT 62/40 200/5 A VA 3 CL 1.....	12
SPCT 62/40 250/5 A VA 2.5 CL 0.5.....	12
SPCT 62/40 250/5 A VA 3 CL 1.....	12
SPCT 62/40 300/5 A VA 3 CL 0.5.....	12
SPCT 62/40 400/5 A VA 3.75 CL 0.5.....	12
SPCT 62/40 400/5 A VA 5 CL 1.....	12
TC203AX-CU.....	16
TC244AX-CU.....	20
TC303AX-CU.....	16
TC344AX-CU.....	20
TC513AX-CU.....	16
TC533AX-CU.....	18
TC544A-1-CU.....	20
TC544A-CU.....	20
TSP04.....	24
VAF36A-110V-CU.....	44
VAF39A-110V-CU.....	44
XC1200-CU.....	28
XC410-CU.....	27
XT5042-CU.....	32
XTC5400-CU.....	29

Timing Diagrams

Timer Selection Guide

TIMING DIAGRAM	1	2	3	4	5	6	7	8	9	10	11	12	13	14	15	16	17	18	19	20	21	22
TIMERS																						
XT5042	X	X			X	X							X	X	X							X
55XU	X	X																				
55ES	X(A)	X(B)																				
55XC					X	X																
600ST	X																					
600XU	X(A)	X(B)					X(C)	X(Ci)	X(D)	X(E)	X(F)	X(H)				X(I)	X(J)	X(K)	X(Ai)	X(Bi)		
600SD																						X
600DT	X(A)	X(B)	X(C)	X(D)			X(E)	X(F)	X(H)	X(J)	X(K)	X(L)				X(P)	X(Q)	X(R)	X(T)	X(U)		
800XU	X	X																				
800XC					X	X																

Function: ON Delay 1

T = set time

Function: Interval 2

T = set time

Function: Asymmetrical Cyclic (OFF 1st) 3

T1 = OFF time ; T2 = ON time

Function: Asymmetrical Cyclic (ON 1st) 4

T1 = OFF time ; T2 = ON time

Function: Cyclic ON First 5

t1 = ON time ; t2 = OFF time

Function: Cyclic OFF First 6

t1 = OFF time ; t2 = ON time

Function: Cyclic Equal OFF First 7

T = set time

Function: Cyclic Equal ON First 8

T = set time

Function: Pulse Output 9

T = Set time ; P = 500msec

Function: Delay On Break 10

T = set time ; t1 < T

Function: Delay On Make / Break 11

T = Set time

Function: Interval After Break 12

T = Set time

Function: Motor Reverse Mode 13

t1 = ON time of Relay1 ; t2 = Pause time ; t3 = ON time of Relay2

Function: Instantaneous + Delayed At Start Pulse 14

t = set time delay

Function: Instantaneous + Delayed At Power ON 15

t = set time delay

Function: Single Shot 16

T = Set time

Function: Retriggerable Single Shot 17

ta < T ; T = Set time

Function: Latching Relay 18

Function: Delay On Make With Totalise 19

t1 + t2 = T ; T = Set time

Function: Interval With Totalise 20

t1 + t2 = T ; T = Set time

Function: Batch 21

Special timer for star delta changeover for star-delta starting of 3 Ø induction motors 22

T1 = Run up time
T2 = Pause time

Earth Leakage Timing Diagram

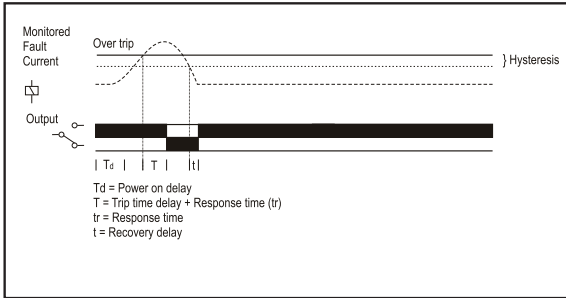

Phase Sequence Relay Timing Diagram

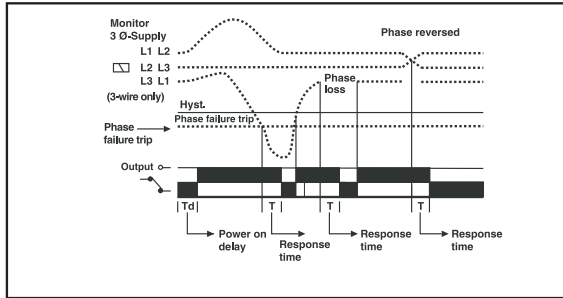

600VPR Voltage Protection Timing Diagram

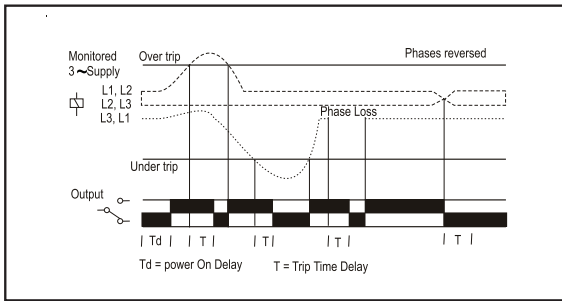

900VPR-BL-U Voltage Protection Timing Diagram

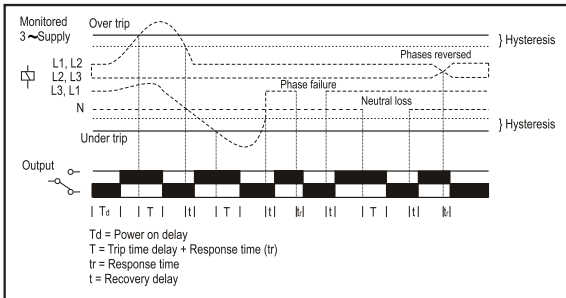

900VPR-2 Voltage Protection Timing Diagram

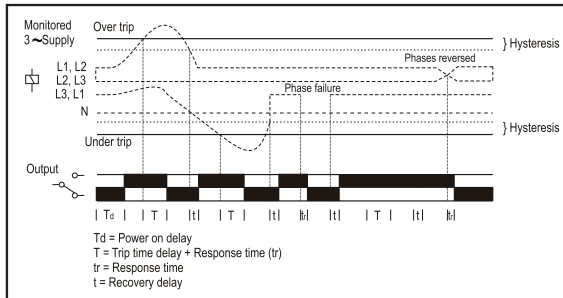

CPR Current Protection Timing Diagram

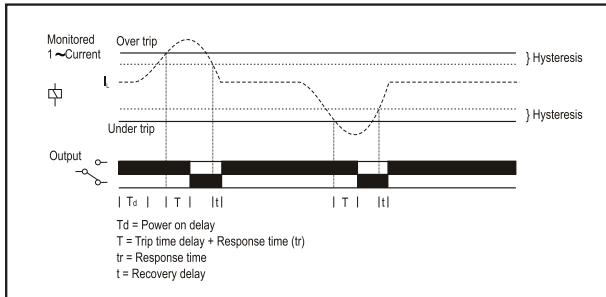

Digital Panel Meters

TYPES

- Digital Multifunction Meter
- Digital Ampere Meter
- Digital Voltage Meter
- Digital Frequency Meter
- Digital Power Factor Meter

FEATURES

- RS485 MODBUS Communication
- Pulse Output (24VDC, 100mA)
- UL Listed
- Faceplate; IP65 Protection Rating
- 7 Segment LED Display or Modern LCD Display
- Available Functions; Voltage, Current, Power, Energy, Frequency and Power Factor (true RMS values)
- Standard DIN sizes (1/4 DIN, 1/8 DIN and 1/16 DIN)
- Analog Bar Graph Indicator for Current Percentage on some models

MFM374-C-CU sample meter.

- RS485 MODBUS Communication (available in MFM and EM Series)
- Pulse Output (24VDC, 100mA)
- UL Listed
- Faceplate; IP65 Protection Rating
- 7 Segment LED Display
- Available Functions; Voltage, Current, Power, Energy, Frequency and Power Factor (true RMS values)

MFM384-C-CU sample meter.

- RS485 MODBUS Communication (available in MFM and EM Series)
- Pulse Output (24VDC, 100mA)
- Analog Bar Graph Indicator for Current Percentage
- UL Listed
- Faceplate; IP65 Protection Rating
- Modern LCD Display
- Available Functions; Voltage, Current, Power, Energy, Frequency and Power Factor (true RMS values)

Standard DIN sizes (1/4 DIN, 1/8 DIN and 1/16 DIN)

Digital Panel Meter Ordering Guide

PART NUMBER	Supply Voltage		Phases		Functions						Display			Pulse Output	RS485 MODBUS Communication
	110VAC	85-270VAC	1 Phase	3 Phase	Voltage	Current	Power Factor	Power	Frequency	Energy	LED Display	LCD	Bar		
MFM384-C-CU		✓		✓	✓	✓	✓	✓	✓	✓		✓	✓	✓	✓
MFM383A-CU		✓		✓	✓	✓	✓	✓	✓	✓		✓		✓	
MFM374-CU		✓		✓	✓	✓	✓	✓	✓	✓	✓			✓	
MFM374-C-CU		✓		✓	✓	✓	✓	✓	✓	✓	✓			✓	✓
VAF36A-110V-CU	✓			✓	✓	✓			✓			✓	✓		
VAF39A-110V-CU	✓			✓	✓	✓			✓		✓				
EM368-C-CU		✓		✓			✓	✓		✓		✓		✓	✓
MA12-110V-CU	✓		✓			✓					✓				
MA12-50mV-DC-110V-CU	✓		✓			✓					✓				
MA12-100mV-DC-110V-CU	✓		✓			✓					✓				
MA501-110V-CU	✓		✓			✓						✓	✓		
MA2301-110V-CU	✓			✓		✓						✓	✓		
MV15-110V-CU	✓		✓		✓						✓				
MV15-DC-20V-110V-CU	✓		✓		✓						✓				
MV15-DC-200V-110V-CU	✓		✓		✓						✓				
MV507-110V-CU	✓		✓		✓							✓	✓		
MV2307-110V-CU	✓			✓	✓							✓	✓		
MF16-110V-CU	✓		✓						✓		✓				
MP14-110V-CU	✓		✓					✓			✓				

Visit AltechCorp.com/HTML/Meters.html

Terms and Conditions

TITLE - Title to the products of ALTECH shall remain with ALTECH until payment is made in full by Customer. Such reservation of title is for the purpose of securing the purchase price and shall not relieve Customer of the duty to inspect the products upon receipt, to notify ALTECH of any deficiencies or defects, and to exercise due care in the use, installation, operation, and maintenance of the products when on the premise of the Customer or under the control of the Customer. Notwithstanding any reservation of title by ALTECH, risk of loss shall pass to customer at any time of shipment.

SHIPMENT AND DELIVERY - All orders for destination in the mainland United States (less Hawaii, Alaska and non-continental United States possessions) will be shipped F.O.B. Flemington, N.J. All destination, shipping and other charges shall be paid by the Customer in accordance with ALTECH's then current shipping and billing practices.

Delivery dates given in the acceptance of any order are approximate. ALTECH shall not be liable for delays in delivery or in performance due to causes beyond its reasonable control including acts of God, acts of Customer, acts of civil or military authority, fires, strikes or other labor disturbances, war, riot or delays in transportation. In the event of such delay, the date of delivery or performance shall be extended for a period equal to the time lost by reason of the delay.

PRICE - PRICES in any ALTECH publication are subject to change without prior notification. Catalog prices are based on prices published in the current price list. All written quotations are valid for thirty (30) days from the date of quotation. Customer shall pay all sales, use, excise or similar taxes whenever ALTECH must itself pay and/or collect such tax from Customer arising out of the sale.

PAYMENT - Customer agrees to make payment within thirty (30) days of date of the invoice from ALTECH. Customer agrees to pay a late payment charge of one and one-half percent (1.5% per month, or the maximum late payment charge permitted by applicable law, whichever is less, on any unpaid amount for each calendar month (or fraction thereof) that such payment is in default. Orders amounting to less than \$100.00 will be billed at \$100.00 plus freight. Full carton purchases are required. In the event of referral to an attorney for collection, reasonable attorney's fees for collection of the overdue amount shall be paid by Customer. In the event payment is not received within 30 days from the date of invoice, any discount shall be cancelled and the full list price will be due.

LIMITED WARRANTY - ALTECH warrants to Customer that the equipment purchases shall be free from defects in material and workmanship under normal use and service for a period of one year from shipment.

Written notice as an explanation of the circumstances of any claim that the equipment has proved defective in material or workmanship shall be given promptly by the Customer to ALTECH.

ALTECH will not be liable for any misuse, improper operations, improper installation, improper maintenance, alteration, modification, accident or unusual degradation of the equipment or parts due to an unsuitable installation environment.

No representation of other affirmation of facts, including but not limited to statements regarding capacity, suitability for use or performance of the equipment, shall be or be deemed to be a warranty or representation by ALTECH for any purpose, nor give rise to any liability or obligation of ALTECH whatsoever.

Customer's sole and exclusive remedy in the event of breach of warranty, as set forth herein, is expressly limited to (1) the correction of the defect by adjustment, repair, modification, or replacement, or (2) issuance of a credit or refund of the purchase price for the defective equipment at ALTECH's election and sole expense.

EXCEPT AS SPECIFICALLY PROVIDED IN THIS AGREEMENT, THERE ARE NO OTHER WARRANTIES EXPRESSED OR IMPLIED INCLUDING BUT NOT LIMITED TO ANY IMPLIED WARRANTIES OR MERCHANTABILITY OR FITNESS FOR A PARTICULAR PURPOSE.

THIS WARRANTY EXTENDS ONLY TO THE CUSTOMER FROM ALTECH OR ITS AUTHORIZED DISTRIBUTOR.

LIMITATION OF LIABILITY - IN NO EVENT, SHALL ALTECH BE LIABLE FOR LOSS OF PROFITS, INDIRECT, SPECIAL, CONSEQUENTIAL OR OTHER SIMILAR DAMAGES ARISING OUT OF ANY BREACH OF THIS AGREEMENT OR OBLIGATIONS UNDER THE AGREEMENT.

ALTECH SHALL NOT BE LIABLE FOR ANY DAMAGES CAUSED BY DELAY IN SHIPMENT, INSTALLATION OR FURNISHING OF EQUIPMENT OR SERVICES UNDER THIS AGREEMENT.

No action arising out of any claimed breach of this Agreement may be brought by either party more than two (2) years after the cause of action has accrued.

PATENT INDEMNITY - ALTECH shall defend or settle any suit or proceeding brought against Customer based on a claim that any equipment made to ALTECH design and furnished hereunder constitutes an infringement of any existing United States patent, provided (ALTECH) is notified promptly in writing and is given complete authorization and information required for the defense, and ALTECH shall pay all damages and costs awarded against Customer, but shall not be responsible for any costs, expense or compromise incurred or made by Customer without ALTECH's prior written consent. If any equipment is in ALTECH's opinion likely to or does become the subject of a claim for patent infringement, ALTECH may at its option and expense procure for Customer the right to continue using the device, modify it to become non-infringing, but in the event ALTECH is not reasonably able to modify, substitute, or otherwise procure for Customer the right to continue using it, ALTECH will remove such equipment and refund to Customer the amount paid in excess of a reasonable rental for past use.

ALTECH shall not be liable for any infringement or claim based upon use of the equipment in combination with other equipment not supplied by ALTECH or with modifications made by Customer.

The foregoing states the entire liability of ALTECH to Customer arising from patent infringement.

SELLER'S REMEDIES - Should Customer fail to make any payment within ten (10) days of its due date, or fail to perform any other of the Customer's obligation hereunder upon thirty (30) days written notice, or should Customer be or become insolvent or be a party to any bankruptcy receivership proceeding prior to full payment of all amounts payable hereunder, ALTECH may: (a) with or without demand or notice to customer declare the entire amount unpaid immediately due and payable; (b) enter upon the premises where the equipment may be found and remove it (Customer shall assemble the equipment and make it available to ALTECH at a place reasonably convenient to both parties and shall permit and assist ALTECH in effecting the retaking and removal of the equipment); and (c) sell any or all the equipment as permitted under applicable law, applying the proceeds of the sale to payment of the expenses of retaking, repairing and selling the equipment, reasonable attorney fees and to the satisfaction of all indebtedness then due and unpaid under this Agreement. Any surplus shall be paid to Customer and any deficiency shall be paid to ALTECH by Customer.

The remedies provided herein shall be cumulative and in addition to all other remedies provided by law or equity or under the Uniform Commercial Code.

GOVERNING LAW - This agreement will be governed by the Laws of the State of New Jersey.

GENERAL - This Agreement shall only become effective and binding when either (a) it has been accepted and executed by an authorized representative of ALTECH, or (b) the equipment has been shipped to Customer, with or without acceptance in writing hereon. Notice of acceptance is hereby waived by Customer. Customer hereby acknowledges receipt of a true and complete copy hereof.

No addition to or modification of any of the Terms and Conditions of Sale as they appear herein shall be binding upon ALTECH unless signed in writing by duly authorized representative of ALTECH in Flemington, N.J.

Typographical and clerical errors in quotations, orders and acknowledgments are subject to correction.

This Agreement is not assignable without the prior written consent of ALTECH. Any attempt to assign any of the rights, duties or obligations of this Agreement without such consent is void.

If any provision or provisions of this Agreement shall be held to be invalid, illegal or unenforceable, the validity, legality and enforceability, of the remaining provisions shall not in any way be affected or impaired thereby.

ALTECH is not responsible for failure to fulfill its obligation under this Agreement due to causes beyond its control, or except as agreed herein.

THE CUSTOMER ACKNOWLEDGES THAT HE HAS READ THE AGREEMENT, UNDERSTANDS IT, AND AGREES TO BE BOUND BY ITS TERMS AND CONDITIONS. FURTHERMORE, THE CUSTOMER AGREES THAT IT IS THE COMPLETE AND EXCLUSIVE STATEMENT OF THE AGREEMENT BETWEEN THE PARTIES, WHICH SUPERSEDES ALL PROPOSALS OR PRIOR AGREEMENTS, ORAL OR WRITTEN, EXPRESSED OR IMPLIED, AND ALL OTHER COMMUNICATIONS BETWEEN THE PARTIES RELATING TO THE SUBJECT MATTER OF THIS AGREEMENT.

Circuit Protection Devices



Altech the market leader in UL508 Manual Motor Controllers/ Miniature Circuit Breakers now introduces UL489 Miniature Circuit Breakers and UL1077 Supplementary Protectors. The UL489 versions are DIN rail mounted, 17.5mm wide, thermal magnetic, 240V, 480Y/277V AC, 50/60Hz, 125 and 250 VDC models, with short circuit interrupt capacity of 10kA, a positive trip indicator, and are line/load reversible. The UL1077 versions are DIN rail mounted, 17.5mm wide, thermal magnetic, 480Y/277V AC, 50/60Hz, a short circuit withstand capacity 10kA, have a positive trip indicator.

Altech Corp.®
35 Royal Rd., Flemington, NJ 08822
908-806-9400
FAX 908-806-9490
www.altechcorp.com

Industrial Enclosures



Altech offers a broad selection of non-metallic and aluminum Industrial Enclosures to meet your diverse design requirements. Sizes range from 1.97 x 2.05 x 1.38 to 35.43 x 11.81 x 5.59 inches. Materials include polycarbonate, polystyrene, polypropylene, ABS or aluminum. Polycarbonate and aluminum series have been recently expanded. Protection up to IP67 (NEMA 4, 4X). Smooth sidewalls or sidewalls with knockouts. Enclosures can be mounted directly onto a panel, frame or other mounting surfaces. EMI / RFI Coating is available. Competitive cover printing is available. Hinge Kits. Customization available.

Altech Corp.®
35 Royal Rd., Flemington, NJ 08822
908-806-9400
FAX 908-806-9490
www.altechcorp.com

Smart Relays



Supports up to 48 I/Os (32 digital inputs and 16 digital outputs). DST Feature Available. Backlit LCD Screen for display and modification of pre-selected parameters of functional blocks, viewing I/O status and programming on the device. PC software for programming, online and offline simulation, documentation and printing. Designed for use in automation for commercial and Industrial sectors. Modbus Communication. UL 508 (UL File No. E352868), IEC 61000-3-2 and IEC 61000-4-2-1~11. 250 lines of ladder programming. 16 soft text messages, Time Switches, Compare Counters, Timers, Counters and 12 analog functions.

Altech Corp.®
35 Royal Rd., Flemington, NJ 08822
908-806-9400
www.altechcorp.com

PCB Spring Clamp and Push-In Terminal Blocks



New spring clamp printed circuit board terminal blocks with push-in technology. Fixed push-in PCB terminals, PCB power terminals push-in, tension spring terminals and push-in plugs.

Altech Corp.®
35 Royal Rd., Flemington, NJ 08822
908-806-9400
www.altechcorp.com

Motor Disconnect Switches



Altech's line of Motor Disconnect Switches are UL 508 listed as Manual Motor Controllers for AC Motor Starting Across-the-line and AC General use. This new 16 page catalog includes the 3 different handle designs, which are all available in gray/black or yellow/red housings. Electrical ratings are 25-150A / 600V. The switches are non-fused DIN Rail mountable. Neat features include: snap-on auxiliary switches, door mounting kit and a retrofit 30A fuse holder. Also featured are Enclosed Motor Disconnect Switches and Fused Enclosed Motor Disconnect Switch (30A) in plastic or stainless housings.

Altech Corp.®
35 Royal Rd., Flemington, NJ 08822
908-806-9400
www.altechcorp.com

Power Supplies



Altech DIN RAIL mountable power supplies have Universal AC input. They are suitable for industrial and automation applications. UL508 Listed or UL Recognized. Single and Three phases up to 960W. Outputs of 5V, 12V, 15V, 24V and 48V. Class 2 devices are available. Installed on DIN rail TS35/ 7.5 or 15. Protections of Short circuit / Overload / Overvoltage / Over temperature. Cooling by free air convection. All-In-One DC-UPS, battery based. Ultra Capacitor DC-UPS, no battery required. Worldwide approvals. 3 year warranty.

Altech Corp.®
35 Royal Rd., Flemington, NJ 08822
908-806-9400
www.altechcorp.com

Altech Search



- Home
- Stock Check
- Distributors
- Information
- News
- Contact
- Rep/Disti Login
- Altech Mexico

WEB TOOLS

- Drawings & Photos
- Enclosure Finder
- Altech Videos
- Request for Quote
- Sample Request
- Catalog Request
- Product Crossings
- eBook Catalog

PRODUCT MENU

- ATEX Products
- Circuit Protection/Control >
- Connectors >
- Enclosures >
- Fuses >
- Digital Panel Meters
- Foot Switches
- Interface Modules >
- Panel Accessories
- Power Supplies
- Power Semi-Conductors
- PCB Connection Technology >
- Programmable Controllers
- Push Buttons & Pilot Lights >
- Relays >
- Sensors >
- Safety Switches >
- Standard Switches >
- Solid State Relays
- Terminal Blocks >
- Test & Measurement

New Products and Promotions

The NEW

Altech ENCLOSURE FINDER



Click here to begin

CIRCUIT PROTECTION

 Circuit Protection Devices	 Busbar & Power Distribution	 Contactors, Overload Relays, Manual Motor Starters	 Motor Disconnect Switches	 European Fuses & Holders
--	---	--	---	--

CONNECTORS

 Pin & Sleeve Devices	 Receptacles
---	--

ENCLOSURES

 Industrial & ATEX Enclosures	 DIN Enclosures	 Control Enclosures and Suspension Systems
---	---	--

FOOT SWITCHES

 Industrial	 Medical
--	---

MODULES & RELAYS

 Interface Modules	 Safety Relays	 Industrial & Slimline Relays
---	---	--

PANEL ACCESSORIES

 Panel Lights	 Heaters, Filters & Thermostats
--	--

SPARE PARTS

 European Spare Parts
--

PILOT DEVICES

 22 & 30 mm Push Buttons & Enclosures	 Pilot Lights & E-Stops
--	--





POWER DEVICES

 Power Supplies	 DC-UPS & Battery Chargers
--	---

POWER MANAGEMENT

 Altech Smart Relays	 Digital Panel Meters	 Digital Timers
---	--	--

SAFETY SWITCHES

 Keyed Safety Switches	 Keyed Solenoid Locking Switches	 Hinged Safety Switches	 Non-Contact Safety Switches	 Safety Rope Pull Switches
---	---	--	---	---

STANDARD SWITCHES

 Light Switches
--

 Dimmer Switches

 Cylindrical & Specialty

 Flat Pack & Box

 Metal Enclosures
--

Altech Corporation
35 Royal Road
Flemington, NJ 08822-6000
P 908.806.9400 • F 908.806.9490
www.altechcorp.com
Altech Corp.® 131-3K-012018
Printed January 2018



Mouser Electronics

Authorized Distributor

Click to View Pricing, Inventory, Delivery & Lifecycle Information:

[Altech:](#)

[SPCT62/40300/5AVA3CL0.5](#) [600VPR-170/290-CU](#) [900VPR-BL-U-CE](#) [900ELR-2-110V-CE](#)