

# XT218A1PAL2

Telemecanique Capacitive proximity sensors  
XT, cylindrical M18, plastic, Sn 8 mm, cable 2  
m



## Main

Range of Product	Telemecanique Capacitive proximity sensors XT
Sensor Type	Capacitive proximity sensor
Product Specific Application	Detection of insulated or conductive materials
Sensor name	XT2
Sensor design	Cylindrical M18
Size	78 mm
Body type	Fixed
Detector flush mounting acceptance	Non flush mountable
Material	Plastic
Enclosure Material	Plastic
Type of output signal	Discrete
Wiring Technique	3-wire
[Sn] nominal sensing distance	0.31 in (8 mm)
Discrete output function	1 NO
Output circuit type	DC
Discrete output type	PNP
Electrical connection	Cable
Cable length	6.56 ft (2 m)
[Us] rated supply voltage	12...24 V DC reverse polarity protection
Maximum delay response	15 ms
IP degree of protection	IP67 double insulation conforming to IEC 60529

## Complementary

ISO thread	M18 x 1
Detection face	Frontal
[Sa] assured operating distance	0.00...0.23 in (0...5.8 mm)
Adjustment zone	0.00...0.47 in (0...12 mm)
Differential travel	< 1...20 % Sr
Repeat accuracy	< 5 % Sr
Wire insulation material	PVC
Status LED	Output state indication 1 LED yellow)
Supply voltage limits	10...30 V DC
Maximum residual current	100 mA open state
Protection Type	Short-circuit protection
Switching frequency	<= 200 Hz
Maximum voltage drop	<2.5 V closed)
Current consumption	< 15 mA
Maximum delay first up	100 ms
Maximum delay recovery	15 ms
Maximum switching current	200 mA
Marking	CE
Setting-up	Sensitivity by potentiometer

Threaded length	1.85 in (47 mm)
Length	3.07 in (78 mm)
Net Weight	0.33 lb(US) (0.15 kg)

## Environment

Standards	EN/IEC 60947-5-2
Product Certifications	cULus
Ambient Air Temperature for Operation	14...140 °F (-10...60 °C)
Vibration resistance	10 gn 1 mm 10...55 Hz)IEC 60068-2-6
Shock resistance	30 gn 11 ms IEC 60068-2-27
Resistance to electrostatic discharge	4 KV contact IEC 61000-4-2 8 kV air IEC 61000-4-2
Resistance to electromagnetic fields	2.74 V/m (3 V/m) IEC 61000-4-3
Resistance to fast transients	2 kV IEC 61000-4-4



## Ordering and shipping details

Category	22490-SENSORS-ULTRASONIC (XX5,6)
Discount Schedule	DS2
GTIN	3389119025997
Returnability	Yes
Country of origin	CN

## Packing Units

Unit Type of Package 1	PCE
Number of Units in Package 1	1
Package 1 Height	0.80 in (2.03 cm)
Package 1 Width	4.80 in (12.19 cm)
Package 1 Length	6.10 in (15.49 cm)
Package 1 Weight	0.26 lb(US) (0.12 kg)
Unit Type of Package 2	S02
Number of Units in Package 2	40
Package 2 Height	5.91 in (15 cm)
Package 2 Width	11.81 in (30 cm)
Package 2 Length	15.75 in (40 cm)
Package 2 Weight	11.15 lb(US) (5.056 kg)

## Offer Sustainability

California proposition 65	WARNING: This product can expose you to chemicals including: Diisononyl phthalate (DINP), which is known to the State of California to cause cancer, and Di-isodecyl phthalate (DIDP), which is known to the State of California to cause birth defects or other reproductive harm. For more information go to <a href="http://www.P65Warnings.ca.gov">www.P65Warnings.ca.gov</a>
REACH Regulation	 <a href="#">REACH Declaration</a>
REACH free of SVHC	Yes
EU RoHS Directive	Pro-active compliance (Product out of EU RoHS legal scope)  <a href="#">EU RoHS Declaration</a>
Toxic heavy metal free	Yes
Mercury free	Yes
RoHS exemption information	 Yes

## Contractual warranty

Warranty	18 months
----------	-----------

Dimensions

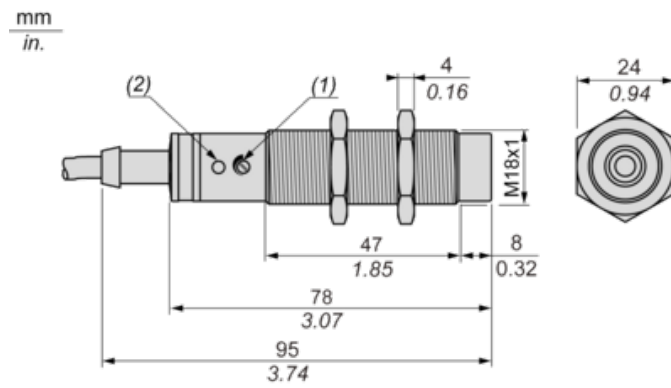

(1) Adjustment potentiometer

(2) LED

## Setting-up

### Minimum Mounting Distances (mm)

Side by side

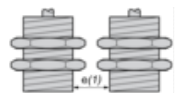

$$e(1) \geq 40$$

Face to face

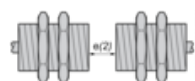

$$e(2) \geq 48$$

Facing a metal object

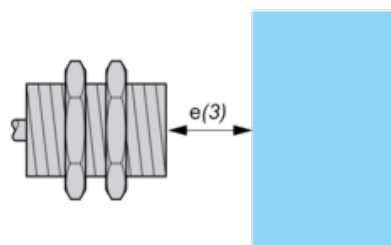

$$e(3) \geq 24$$

Mounted in support

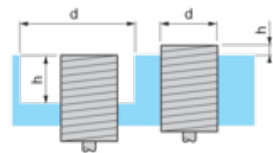

$$d \geq 60$$

$$h \geq 20$$

Fixing nut tightening torque: 3 N.m

## Adjustment

### Sensitivity Adjustment

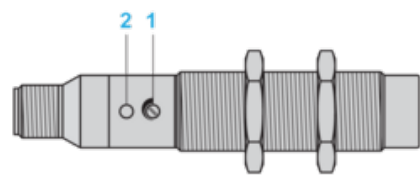

(1) Adjustment potentiometer

(2) LED

---

## Wiring Diagram

---

### Pre-cabled

3-wire DC, PNP NO Output

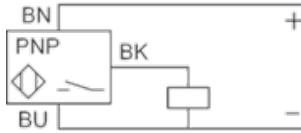

(BU) Blue

(BN) Brown

(BK) Black

# Mouser Electronics

Authorized Distributor

Click to View Pricing, Inventory, Delivery & Lifecycle Information:

[Telemecanique Sensors:](#)

[XT218A1PAL2](#)