

# Technical Information

## Liquipoint FTW33

Conductive and capacitance point level measurement



Point level switch for liquid and pasty media in the food and beverage industry

### Application

The Liquipoint FTW33 is a point level switch for liquid and pasty media.

It is used preferably in storage tanks, mixing vessels and pipes. Developed and built for the food and beverage industry, the Liquipoint FTW33 meets international hygienic requirements.

It is particularly suited to applications where flush-mounting is necessary.

The Liquipoint FTW33 can be used permanently in process temperatures up to 100 °C (212 °F) and for 60 minutes in cleaning and sterilization processes up to 150 °C (302 °F).

The Liquipoint FTW33 can also be used for detecting the foam that commonly occurs within the food and beverage industry.

### Your benefits

- Flush-mounted installation, pipes remain piggable
- For water- and oil-based media with a dielectric constant  $\geq 2$
- No adjustment to the medium in question is required
- Reliable switching function due to compensation even in the case of heavy buildup
- Easy installation thanks to compact design - even in tight conditions or where access is restricted
- Wide range of process connections for installation in new or existing systems
- Robust stainless steel housing, optionally available with M12x1 connector with IP69K protection
- Onsite function check via LED indication
- Can be cleaned and sterilized in place (CIP/SIP)
- 3-A and EHEDG certificates
- Meets the requirements of EU 1935/2004, 10/2011 as well as 2023/2006 and FDA 21 CFR 177.2415





## Table of contents

<b>Document information</b> . . . . .	<b>3</b>	Materials . . . . .	11
Document conventions . . . . .	3	<b>Operability</b> . . . . .	<b>11</b>
<b>Function and system design</b> . . . . .	<b>3</b>	Light signals (LED) . . . . .	11
Measuring principle . . . . .	3	Test magnet . . . . .	12
Measuring system . . . . .	3	<b>Certificates and approvals</b> . . . . .	<b>12</b>
<b>Input</b> . . . . .	<b>4</b>	CE mark . . . . .	12
Measured variable . . . . .	4	C-Tick symbol . . . . .	13
Measuring range . . . . .	4	Approval . . . . .	13
<b>Output</b> . . . . .	<b>4</b>	Sanitary compatibility . . . . .	13
DC-PNP switch output . . . . .	4	Hygienic approval . . . . .	13
<b>Power supply</b> . . . . .	<b>4</b>	Inspection certificates . . . . .	13
Supply voltage . . . . .	4	<b>Ordering information</b> . . . . .	<b>14</b>
Power consumption . . . . .	4	Product Configurator . . . . .	14
Current consumption . . . . .	4	<b>Accessories</b> . . . . .	<b>14</b>
Electrical connection . . . . .	5	Process adapter M24 . . . . .	14
Cable specification . . . . .	6	Weld-in adapter . . . . .	14
Connecting cable length . . . . .	6	Slotted nut DIN11851 . . . . .	14
Overvoltage protection . . . . .	6	Additional accessories . . . . .	14
<b>Performance characteristics</b> . . . . .	<b>7</b>	<b>Supplementary documentation</b> . . . . .	<b>15</b>
Reference operating conditions . . . . .	7	Operating Instructions . . . . .	15
Measured error . . . . .	7	Supplementary documentation . . . . .	15
Hysteresis . . . . .	7		
Non-repeatability . . . . .	7		
Switching delay . . . . .	7		
Switch-on delay . . . . .	7		
<b>Installation</b> . . . . .	<b>7</b>		
Orientation . . . . .	7		
<b>Environment</b> . . . . .	<b>8</b>		
Ambient temperature range . . . . .	8		
Derating curve . . . . .	8		
Storage temperature . . . . .	8		
Climate class . . . . .	8		
Altitude . . . . .	8		
Degree of protection . . . . .	8		
Shock resistance . . . . .	8		
Vibration resistance . . . . .	8		
Cleaning . . . . .	8		
Electromagnetic compatibility . . . . .	8		
Reverse polarity protection . . . . .	8		
Short-circuit protection . . . . .	8		
<b>Process</b> . . . . .	<b>9</b>		
Process temperature range . . . . .	9		
Process pressure range . . . . .	9		
State of aggregation . . . . .	9		
Standard and Extended . . . . .	9		
<b>Mechanical construction</b> . . . . .	<b>10</b>		
Weight . . . . .	10		

## Document information

### Document conventions

### Symbols for certain types of information or in graphics

Symbol	Meaning
	<b>Permitted</b> Indicates procedures, processes or actions that are allowed.
	<b>Preferred</b> Indicates procedures, processes or actions that are preferred.
	<b>Tip</b> Indicates additional information.
	<b>Forbidden</b> Indicates procedures, processes or actions that are forbidden.
	<b>Reference to page</b> Refers to the corresponding page number.

### Symbols for graphics

Symbol	Meaning
1, 2, 3 ...	Item numbers
A, B, C, ...	Views

## Function and system design

### Measuring principle

A low, galvanically isolated AC voltage is applied at the electrode in contact with the process. If liquid or pasty media come in contact with the electrode, a measurable current flows and the Liquipoint FTW33 switches. Active buildup compensation ensures reliable switching of the measuring device even if buildup occurs on the sensor.

### Measuring system

The measuring system consists of a Liquipoint FTW33 point level switch, e.g. for connection to programmable logic controllers (PLC).

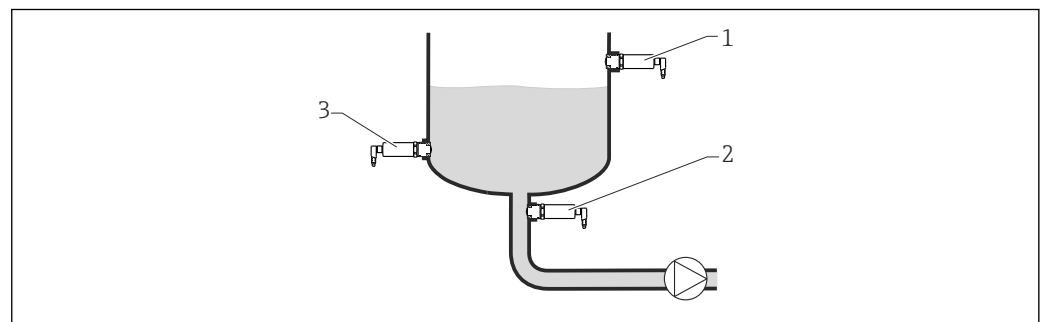

#### 1 Application examples

- 1 Overfill protection or upper level detection (MAX)
- 2 Pump dry running protection (MIN)
- 3 Lower level detection (MIN)

A0016816

## Input

---

**Measured variable** Covered by medium at the electrode in contact with the process

---

**Measuring range** Independent of electrical conductivity.

- Standard: Water- or alcohol-based media, Dielectric constant  $\geq 10$
- Extended: Oil-based media  $2 < DC < 10$  or media that form heavy buildup

More information on the "Standard" and "Extended" settings →  9

## Output

---

**DC-PNP switch output**

- Function: positive voltage signal at the switch output of the electronics
- Switching behavior: ON/OFF
- Connectable load: 200 mA (short-circuit proof)
- Safety-oriented switching: MIN or MAX point level
  - The electrical switch opens if the point level is reached or if faults or a power outage occur.
  - Maximum point level detection (MAX): e.g. as overflow protection
    - The device keeps the electrical switch closed as long as the sensor is not yet covered by liquid.
  - Minimum point level detection (MIN) e.g. for dry-running protection in pumps
    - The device keeps the electrical switch closed as long as the sensor is covered by liquid.
- Residual voltage:  $< 3\text{ V}$
- Residual current:  $< 100\ \mu\text{A}$

## Power supply

---

**Supply voltage** 10 to 30 V DC

---

**Power consumption**  $< 1\text{ W}$  (at max. load: 200 mA)

---

**Current consumption**  $< 15\text{ mA}$

**Electrical connection**

Voltage source: non-hazardous contact voltage or Class 2 circuit (North America). The device must be operated with a fine-wire fuse 500 mA (slow-blow).

**M12 connector**



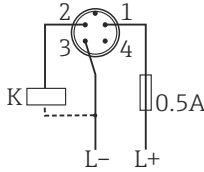
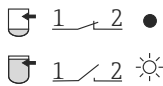
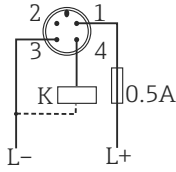
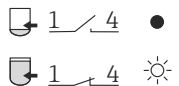



Depending on the evaluation of the switch outputs, the device works in MAX (maximum point level detection) or MIN (minimum point level detection) mode.

Electrical connection	Mode	
	MAX	MIN
 <small>A0022901</small>	 	 
<p><b>Symbols Description</b></p> <ul style="list-style-type: none"> <li>☀ Yellow LED (ye) lit</li> <li>• Yellow LED (ye) not lit</li> <li>K external load</li> </ul>		

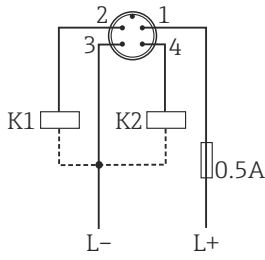
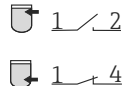
**Function monitoring, M12 connector**

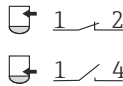

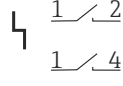



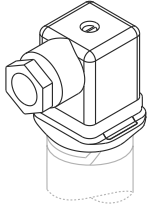
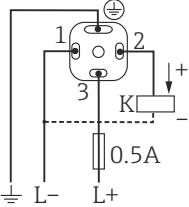

With two-channel evaluation, functional monitoring of the sensor is also possible in addition to level monitoring.

When both outputs are connected, the MIN and MAX outputs assume opposite states when the device is operating fault-free (XOR). In the event of an alarm condition or a line break, both outputs are deenergized.

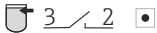
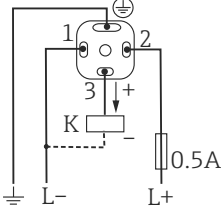
Connection for function monitoring with antivalence	Yellow LED (ye)	Red LED (rd)
 <small>A0022917</small>	<p><b>Sensor covered</b></p> 	
	<p><b>Sensor uncovered</b></p> 	
	<p><b>Fault</b></p> 	
<p><b>Symbols Description</b></p> <ul style="list-style-type: none"> <li>☀ LED lit</li> <li>• LED not lit</li> <li>⚡ Fault or warning</li> <li>K1 / K2 external load</li> </ul>		

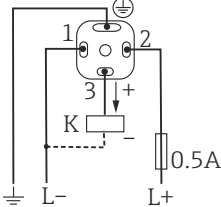
### Valve plug, cable

Depending on the assignment of the connector or the wiring of the cable, the device works in either the MAX or MIN operating mode.

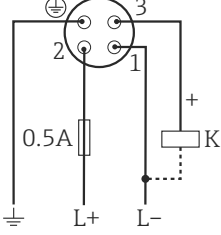
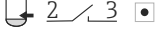
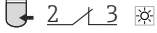
Electrical connection	Mode									
 <p>A0022900</p>	<p>MAX</p>  <p>   </p>	<p>MIN</p>  <p>   </p>								
<p>Cable (cannot be dismantled)</p>  <p>A0022902</p> <p>Core colors:            1 = BK (black)            2 = GR (gray)            3 = BN (brown)            Ground = GNYE (green-yellow)</p>	 <p>   </p>	 <p>   </p>								
<table border="0"> <thead> <tr> <th data-bbox="408 1200 528 1234">Symbols</th> <th data-bbox="528 1200 655 1234">Description</th> </tr> </thead> <tbody> <tr> <td data-bbox="408 1234 528 1267">●</td> <td data-bbox="528 1234 655 1267">Yellow LED (ye) not lit</td> </tr> <tr> <td data-bbox="408 1267 528 1301">☒</td> <td data-bbox="528 1267 655 1301">Yellow LED (ye) lit</td> </tr> <tr> <td data-bbox="408 1301 528 1319">K</td> <td data-bbox="528 1301 655 1319">external load</td> </tr> </tbody> </table>			Symbols	Description	●	Yellow LED (ye) not lit	☒	Yellow LED (ye) lit	K	external load
Symbols	Description									
●	Yellow LED (ye) not lit									
☒	Yellow LED (ye) lit									
K	external load									

### Cable specification

- M12 connector: IEC 60947-5-2
- Valve plug
  - Cable cross-section: max. 1.5 mm<sup>2</sup> (16 AWG)
  - Ø 3.5 to 6.5 mm (0.14 to 0.26 in)
- Cable (3LPE)
  - Cable cross-section: 0.75 mm<sup>2</sup> (20 AWG)
  - Ø6 to 8 mm (0.24 to 0.31 in)
  - Material: PUR

### Connecting cable length

max. 25 Ω/core, total capacitance < 100 nF

### Overvoltage protection

Overvoltage category II

## Performance characteristics

<b>Reference operating conditions</b>	Horizontal orientation: <ul style="list-style-type: none"> <li>■ Ambient temperature: 20 °C (68 °F) ±5 °C</li> <li>■ Medium temperature: 20 °C (68 °F) ±5 °C</li> <li>■ Process pressure: 1 bar (14.5 psi)</li> <li>■ Medium: water</li> <li>■ Conductivity: approx. 200 µS/cm</li> </ul>
<b>Measured error</b>	±1 mm (0.04 in) in accordance with DIN 61298-2
<b>Hysteresis</b>	max. 1 mm (0.04 in)
<b>Non-repeatability</b>	±0.5 mm (0.02 in) in accordance with DIN 61298-2
<b>Switching delay</b>	<ul style="list-style-type: none"> <li>■ 0.5 s when sensor is covered;</li> <li>■ 1.0 s when sensor is uncovered</li> <li>■ Optional: 0.3 s; 1.5 s or 5 s when sensor is covered and uncovered, see product structure, order code for "Service", option HS "switching delay"</li> </ul>
<b>Switch-on delay</b>	< 1 s (no defined switching status before this)

## Installation

### Orientation

The measuring device can be installed in any position. Using a socket wrench, the measuring device can also be installed at measuring points that are difficult to access.

The socket wrench can be ordered either together with the device or separately as an accessory, see "Accessories" section → 14.

In horizontal pipes:

**i** Vertical orientation can affect the measurement. It can be influenced by the fact that the sensor is not completely covered with liquid or by air bubbles at the sensor.

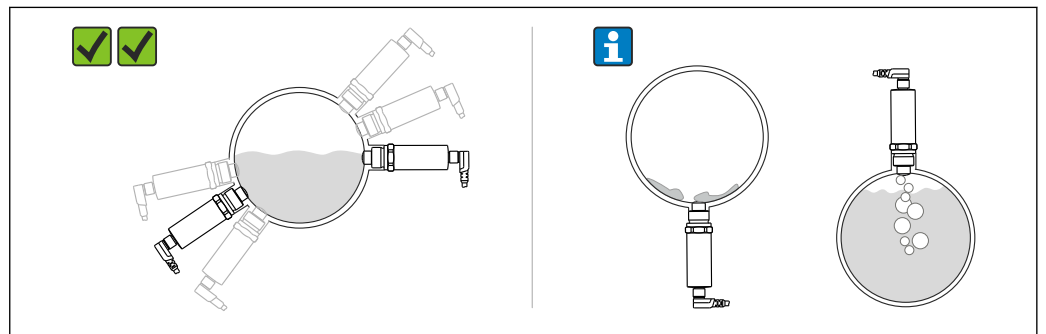

A0016834

**2** Installation in horizontal pipes

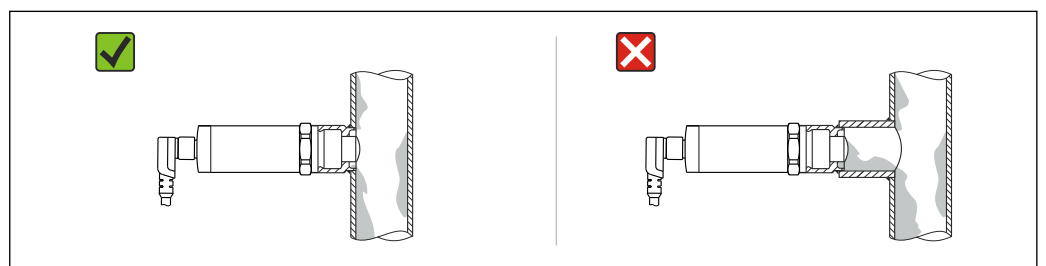

A0025915

**3** Flush-mounted installation for highly viscous media

## Environment

**Ambient temperature range** -40 to +70 °C (-40 to +158 °F), see the following derating diagram:

**Derating curve**

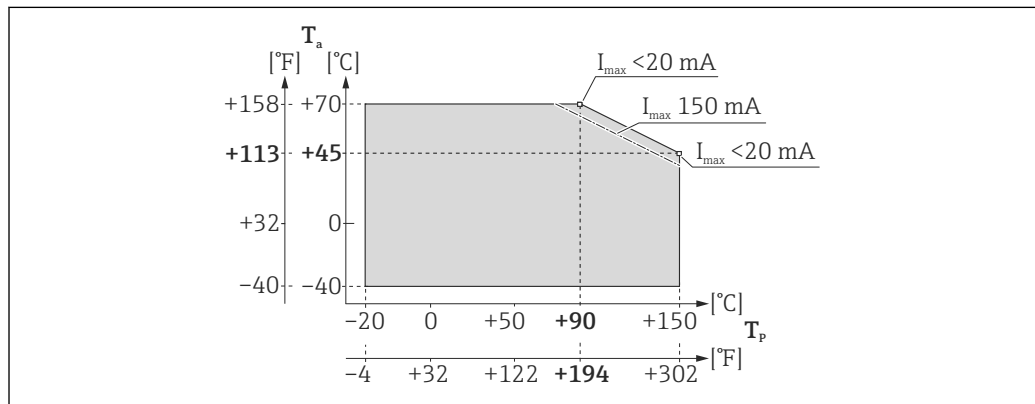

$T_a$  Ambient temperature

$T_p$  Process temperature

**Storage temperature** -40 to +85 °C (-40 to +185 °F)

**Climate class** DIN EN 60068-2-38/IEC 68-2-38: test Z/AD

**Altitude** Up to 2 000 m (6 600 ft) above sea level

**Degree of protection**

- IP65 (valve plug)
- IP65/67 NEMA type 4X enclosure (M12 connector for plastic housing cover)
- IP66/68/69K NEMA type 4X/6P enclosure (M12 connector for metal housing cover)
- IP66/68 NEMA Type 4X/6P Enclosure (cable)

**Shock resistance** In accordance with test Ea, prEN 60068-2-27:2007:  $a = 300 \text{ m/s}^2 = 30 \text{ g}$ , 3 planes x 2 directions x 3 shocks x 18 ms

**Vibration resistance** In accordance with test Fh, EN 60068-2-64:2008:  $a(\text{RMS}) = 50 \text{ m/s}^2$ ,  $f = 5$  to 2000 Hz,  $t = 3$  planes x 2 h

**Cleaning** Resistant to typical cleaning agents from the outside, in accordance with Ecolab test.

**Electromagnetic compatibility** Electromagnetic compatibility in accordance with all of the relevant requirements outlined in the EN 61326 series and NAMUR Recommendation EMC (NE 21). For details, refer to the Declaration of Conformity.

**Reverse polarity protection** Integrated; no damage in the event of reverse polarity or short-circuit

**Short-circuit protection** Overload protection/short-circuit protection at  $I > 250 \text{ mA}$ ; the sensor is not destroyed.  
Intelligent monitoring: Testing for overload at intervals of approx. 1.5 s; normal operation resumes once the overload/short-circuit has been rectified



## Process

<b>Process temperature range</b>	-20 to +100 °C (-4 to +212 °F) <ul style="list-style-type: none"> <li>■ For 1 hour: +150 °C (+302 °F)</li> <li>■ For 1 hour for M24 process adapter with EPDM process seal: +130 °C (+266 °F)</li> </ul>
<b>Process pressure range</b>	-1 to +25 bar (-14.5 to +362.5 psi)
<b>State of aggregation</b>	Liquid

**Standard and Extended** For reliable point level detection, the Liquipoint FTW33 can be adapted to the process conditions in question. The following settings can be made on the device using the test magnet:

- **Standard:** For water- or alcohol-based media (Dielectric constant  $\geq 10$ ), which generate little or no buildup, select the "Standard" setting (e.g. water, milk and various dairy products, soft drinks, beer).
- **Extended:** For oil-based media ( $2 < DC < 10$ ) or media which generate heavy buildup, select the "Extended" setting (e.g. oils, ketchup, mustard, mayonnaise, honey, nougat spread).

 For dielectric constants (DC values) of many media commonly used in various industries refer to:

- the Endress+Hauser DC manual (CP01076F)
- the Endress+Hauser "DC Values App" (available for Android and iOS)

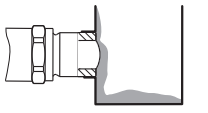
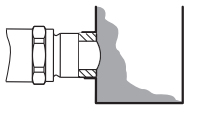
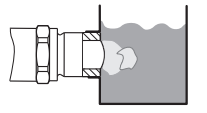
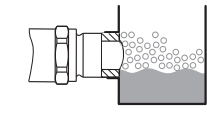
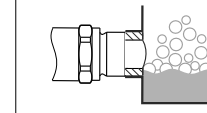
Settings	Process conditions				
	Adhesive and viscous media			Foaming media	
	Light buildup  A0016835	Heavy buildup  A0016836	Surface drying  A0016837	Fine-pored  A0016838	Coarsely pored  A0016839
<b>Standard</b>	<input checked="" type="checkbox"/> <input checked="" type="checkbox"/>	<input checked="" type="checkbox"/>	<input checked="" type="checkbox"/> <input checked="" type="checkbox"/>	Sensor signal "covered" if foam present	Sensor signal "free" if foam present <sup>1)</sup>
<b>Extended</b>	2)	<input checked="" type="checkbox"/>	2)	Sensor signal "free" if foam present	Sensor signal "free" if foam present

1) Very coarsely pored foam can no longer be detected by the sensor.  
 2) Surface drying or insulating, non-homogeneous layers can cause the sensor to signal "free" and should therefore be avoided or eliminated, particularly in MAX safety mode (overflow). The Standard setting is preferable in this type of application.

**Default value:** The measuring device is shipped with "Standard" as the default setting. Optionally, it can be ordered with "Extended" as the default setting. See the product structure, order code for "Service", option HD "Preset: Extended".

## Mechanical construction

Engineering unit mm (in)

Liquipoint FTW33		Electrical connection							
		M12 connector		Valve plug		Cable <sup>1)</sup>			
		A0016840		A0016842		A0024600			
		<b>Housing cover</b>							
		Plastic M12	Metal M12	Plastic valve plug					
		A0016846	A0016845	A0016847					
	H1	21 (0,83)		16 (0,63)		46 (1,82)			
		<b>Housing</b>							
	A0016848								
H2	58 (2,28)								
	<b>Process connection</b>								
2)	3CJ	3EJ	1AJ	1CJ	W5J	WSJ	X2J	WVJ	
	Clamp		Milk pipe		Thread				
	DN25-38 1...1½"	DN40 2"	DN25 PN40	DN40 PN40	G ¾"	G 1"	M24x1.5	G ½" Hygiene adapter	
	A0016849	A0016850	A0016851	A0016852	A0016853	A0016776	A0016854	A0016855	
H3	36 (1,42)				41 (1,61)	43 (1,69)	41 (1,61)	50 (1,97)	
H4	-				16 (0,63)	19 (0,75)	13 (0,51)	15 (0,59)	
H5	-				28 (1,1)	32 (1,3)	19 (0,8)	37 (1,5)	
H6	2 (0,08)								

1) Cable and housing cover are welded at time of delivery and cannot be removed

2) For a description of the options, see the product structure, order code for "Process connection"

**Weight** approx. 300 g (10.58 oz)

**Materials**

Material specifications in accordance with AISI and DIN EN.

Materials in contact with process	Materials not in contact with process
Sensor: 316L (1.4404), PEEK The material PEEK meets the requirements of EU 1935/2004, 10/2011 as well as 2023/2006 and FDA 21 CFR 177.2415	Housing covers: <ul style="list-style-type: none"> <li>■ M12 metal: 316L (1.4404)</li> <li>■ M12 plastic: PPSU</li> <li>Design ring: PBT/PC</li> <li>■ Valve connector, plastic: PPSU</li> <li>■ Plastic cable: PPSU</li> </ul>
Process connection: 316L (1.4404/1.4435)	Housing: 316L (1.4404) Nameplate: lasered onto housing

Metallic surface in contact with process: Ra ≤ 0.76 µm (30 µin)

**i** Endress+Hauser supplies DIN/EN process connections with threaded connection in stainless steel in accordance with AISI 316L (DIN/EN material number 1.4404 or 14435). With regard to their stability-temperature property, the materials 1.4404 and 1.4435 are grouped together under 13EO in EN 1092-1, Tab. 18. The chemical composition of the two materials can be identical.

**Operability**

**Light signals (LED)**

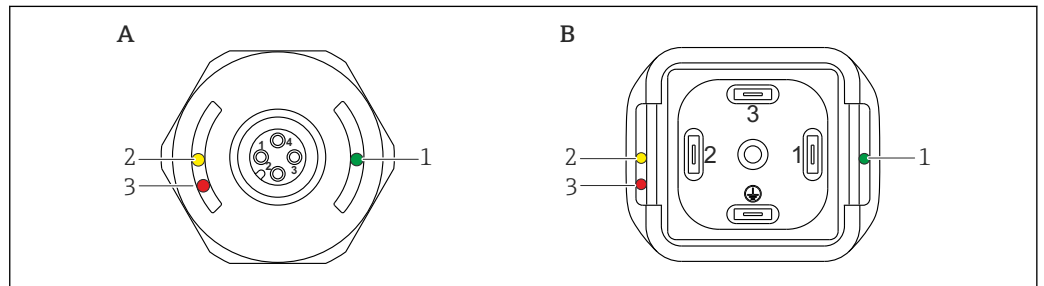

**4** Position of LEDs on housing cover  
 A M12 connector, (cable without graphic)  
 B Valve plug

Item	Function	Description
1	Green LED (gn)	LED is lit: the device is operational
2	Yellow LED (ye)	<b>M12 connector</b> Indicates the sensor state: Sensor is covered by liquid  <b>Valve plug / cable</b> Indicates the switching state: <ul style="list-style-type: none"> <li>■ MAX operating mode (overflow prevention): sensor is <b>not</b> covered by liquid</li> <li>■ MIN operating mode (dry running protection): the sensor is covered by liquid</li> </ul>
3	Red LED (rd)	Warning or malfunction

**i** For the metallic housing cover (IP69K), there is no external signaling via LEDs. A connecting cable with an M12 connector and LED display can be ordered as an accessory → **14**.

**Test magnet**

The test magnet is included in the scope of delivery.

The measuring device is shipped with "Standard" as the default setting. Optionally, it can be ordered with "Extended" as the default setting, see order code on the nameplate: FTW33-\*\*\*\***HD**\*\*\*\*.

**Standard:** The green LED is continuously lit when the device is started.

**Extended:** The green LED flashes for approx. 5 seconds when the device is started and is then continuously lit.

**Switching between the Standard and Extended settings**

- A:** Hold the test magnet against the marking on the housing.  
Start the device (operating voltage applied, voltage restored).
- B:** After at least 10 seconds, the measuring device has switched to Standard or Extended mode.  
Without LEDs: After at least 15 seconds.
- C:** After at least 30 seconds, the measuring device has reset to the default value.  
Without LEDs: After at least 35 seconds.

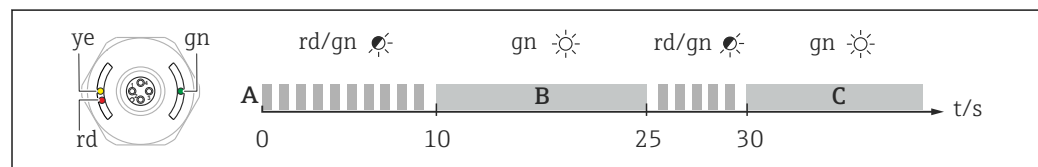

A0026044

5 Time diagram for settings and default value

**Function test**

Carry out a function test while the device is in operation.

- ▶ Hold the test magnet against the marking on the housing for at least 2 seconds.
  - ↳ This inverts the current switch status, and the yellow LED changes state. When the magnet is removed, the switching status valid at that time is adopted.

If the test magnet is held against the marking for longer than 30 seconds, the red LED will flash: The device returns automatically to the current switch status.

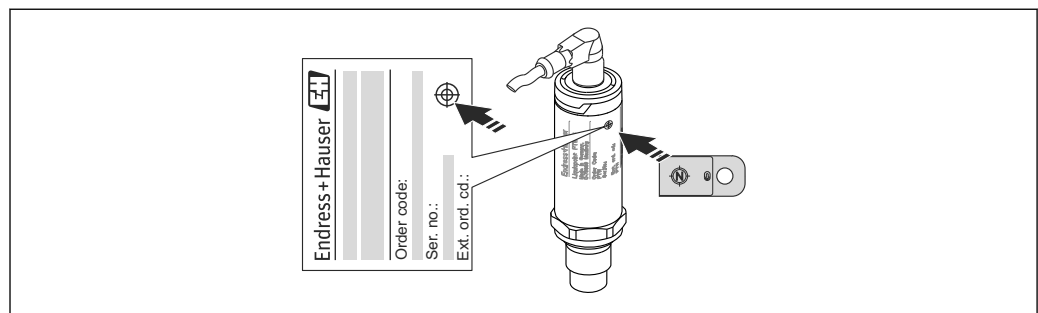

A0024532

6 Position for test magnet on housing

**Certificates and approvals****CE mark**

The measuring system is in conformity with the statutory requirements of the applicable EC Directives. These are listed in the corresponding EC Declaration of Conformity along with the standards applied.

Endress+Hauser confirms successful testing of the device by affixing to it the CE mark.

**C-Tick symbol** The measuring system complies with EMC requirements of the "Australian Communications and Media Authority (ACMA)".

**Approval** CSA C/US General Purpose

**Sanitary compatibility** The device has been developed for use in hygienic processes. The materials in contact with the process meet FDA requirements as well as the 3-A Sanitary Standard No. 74-xx. Endress+Hauser confirms this by affixing the 3-A symbol to the device.

The following certificate copies can be ordered with the device (optional):

3-A



EHEDG



- If cleaning in place (CIP) is required, weld-in adapters that comply with 3-A requirements are offered. If installed horizontally, ensure that the leakage hole is pointing downwards. This allows leaks to be detected as quickly as possible.
- To avoid the risk of contamination, install the device in accordance with the design principles of EHEDG, Document 37 "Hygienic Design and Application for Sensors" and Document 16 "Hygienic Pipe Connections".
- Suitable connections and seals must be used in order to guarantee a hygienic design in accordance with the specifications of 3-A and EHEDG.
- Information on 3-A and EHEDG-approved weld-in adapters can be found in the "Weld-in adapter, process adapter and flanges" documentation, TI00426F/00/EN.
- The gap-free connections can be cleaned of all residue using sterilization in place (SIP) and cleaning in place (CIP), which are typical cleaning methods within the industry. Attention must be paid to the pressure and temperature specifications of the sensor and process connections for CIP and SIP processes.

**Hygienic approval** Information on 3-A and EHEDG-approved weld-in adapters can be found in the "Weld-in adapter and flanges" documentation, TI00426F/00/EN.

The options can be selected via the product structure in the Product Configurator, see the "Ordering information" section → 14.

Process connections	Option	Approvals	
		EHEDG	3-A
Thread ISO228 G ½", 316L, process sleeve installation accessory	WVJ	-	-
Thread ISO228 G 1, 316L, weld-in adapter installation accessory	WSJ	✓	✓
Thread ISO228 G ¾", 316L, weld-in adapter installation accessory	W5J	✓	✓
Thread M24, 316L, installation, adapter accessory	X2J	✓	✓
DIN11851 DN25 PN40 without slotted nut, 316L	1AJ	✓	✓
DIN11851 DN40 PN40 without slotted nut, 316L	1CJ	✓	✓
Tri-Clamp ISO2852 DN25-38 (1 to 1-½"), 316L, DIN32676 DN25-40	3CJ	✓	✓
Tri-Clamp ISO2852 DN40-51 (2"), 316L, DIN32676 DN50	3EJ	✓	✓

**Inspection certificates** The following documents can be ordered with the device (optional):

- Acceptance test certificate as per EN 10204-3.1
- Test report of surface roughness ISO4287/Ra
- Final inspection report

## Ordering information

### Product Configurator



Product Configurator - the tool for individual product configuration

Detailed ordering information is available from the following sources:

- In the Product Configurator on the Endress+Hauser website: [www.endress.com](http://www.endress.com) → Select country → Instruments → Select device → Product page function: Configure this product
- From your Endress+Hauser Sales Center: [www.endress.com/worldwide](http://www.endress.com/worldwide)
- Up-to-the-minute configuration data
- Depending on the device: Direct input of measuring point-specific information such as measuring range or operating language
- Automatic verification of exclusion criteria
- Automatic creation of the order code and its breakdown in PDF or Excel output format
- Ability to order directly in the Endress+Hauser Online Shop

## Accessories

The accessories can be ordered either together with the device or separately.

The adapters are also available with inspection certificate 3.1 EN10204.

### Process adapter M24

For information on the process and weld-in adapters, please refer to the supplementary documentation → 15.

Process adapter M24 for:	Pressure rating PN
Varivent N	40
Varivent F	40
DIN11851 DN50 with slotted nut	25
SMS 1 ½"	25
Material: 316L (1.4435) Seal for process adapter with M24 thread: EPDM	

### Weld-in adapter

For thread:	Description
G ¾"	ø50 vessel installation, ø29 pipe installation
G 1"	ø53 pipe installation, ø60 vessel installation
M24	ø65 vessel installation
Material: 316L (1.4435) Seal for weld-in adapter G ¾", G 1": VMQ (silicone)	

### Slotted nut DIN11851

For milk pipe:	
DN50	F50
DN40	F40
DN25	F26
Material: 304 (1.4307)	

### Additional accessories

Description	Order number
Test magnet	71267011
Socket wrench, hex bolt, 32 AF	52010156
Cable, plug-in jack Engineering unit mm (in)	<b>M12 IP69K with LED</b> <ul style="list-style-type: none"> <li>▪ elbowed 90°, terminated at one end</li> <li>▪ 5 m (16 ft) cable PVC (orange)</li> </ul>
	52018763

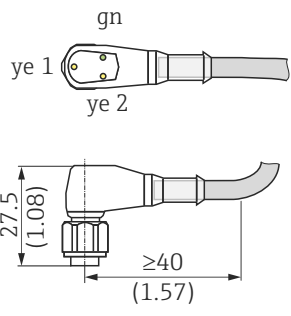
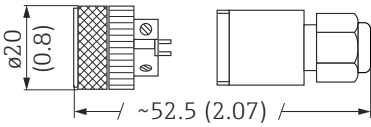
Description	Order number
 <p>Example: M12 with LED</p>	<ul style="list-style-type: none"> <li>Body: PVC (transparent)</li> <li>Slotted nut 316L</li> </ul> <p><b>M12 IP69K without LED</b></p> <ul style="list-style-type: none"> <li>elbowed 90°, terminated at one end</li> <li>5 m (16 ft) cable PVC (orange)</li> <li>Body: PVC (orange)</li> <li>Slotted nut 316L (1.4435)</li> </ul>
	<p><b>M12 IP67 without LED</b></p> <ul style="list-style-type: none"> <li>elbowed 90°</li> <li>5 m (16 ft) cable PVC (gray)</li> <li>Slotted nut Cu Sn/Ni</li> <li>Body: PUR (blue)</li> </ul>
<p><b>core colors for M12 connector:</b> 1 = BN (brown), 2 = WT (white), 3 = BU (blue), 4 = BK (black)</p>	

## Supplementary documentation



The following document types are also available in the Download Area of the Endress+Hauser web site: [www.endress.com](http://www.endress.com) → Download

### Operating Instructions

Liquipoint FTW33 → BA00418F/00/EN

### Supplementary documentation

- Process adapter, weld-in adapter and flanges (overview) → TI00426F/00/EN
- Weld-in adapter G 1", G 3/4" (installation instructions) → SD00352F/00/A6
- Weld-in adapter M24 (installation instructions) → BA00361F/00/A6



[www.addresses.endress.com](http://www.addresses.endress.com)

---



# Mouser Electronics

Authorized Distributor

Click to View Pricing, Inventory, Delivery & Lifecycle Information:

[Endress+Hauser:](#)

[FTW33-AA4NWSJ](#) [FTW33-AA4SW5J](#) [FTW33-CA4M3EJ](#) [FTW33-AA4M1AJ](#) [FTW33-CA4MWVJ](#) [FTW33-AA4N3CJ](#)  
[FTW33-AA4N3EJ](#) [FTW33-CA4N3EJ](#) [FTW33-CA4M3CJ](#) [FTW33-AA4M3CJ](#) [FTW33-AA4MW5J](#)