



October 2014

## BC846 / BC847 / BC848 / BC850 NPN Epitaxial Silicon Transistor

### Features

- Switching and Amplifier Applications
- Suitable for Automatic Insertion in Thick and Thin-film Circuits
- Low Noise: BC850
- Complement to BC856, BC857, BC858, BC859, and BC860

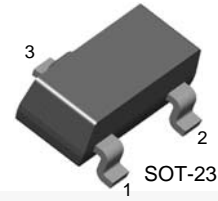

1. Base 2. Emitter 3. Collector

### Ordering Information<sup>(1)</sup>

Part Number	Marking	Package	Packing Method
BC846AMTF	8AA	SOT-23 3L	Tape and Reel
BC846BMTF	8AB	SOT-23 3L	Tape and Reel
BC846CMTF	8AC	SOT-23 3L	Tape and Reel
BC847AMTF	8BA	SOT-23 3L	Tape and Reel
BC847BMTF	8BB	SOT-23 3L	Tape and Reel
BC847CMTF	8BC	SOT-23 3L	Tape and Reel
BC848BMTF	8CB	SOT-23 3L	Tape and Reel
BC848CMTF	8CC	SOT-23 3L	Tape and Reel
BC850AMTF	8EA	SOT-23 3L	Tape and Reel
BC850CMTF	8EC	SOT-23 3L	Tape and Reel

#### Note:

1. Affix "-A,-B,-C" means  $h_{FE}$  classification. Affix "-M" means SOT-23 package. Affix "-TF" means the tape and reel type packing.

BC846 / BC847 / BC848 / BC850 — NPN Epitaxial Silicon Transistor

## Absolute Maximum Ratings

Stresses exceeding the absolute maximum ratings may damage the device. The device may not function or be operable above the recommended operating conditions and stressing the parts to these levels is not recommended. In addition, extended exposure to stresses above the recommended operating conditions may affect device reliability. The absolute maximum ratings are stress ratings only. Values are at  $T_A = 25^\circ\text{C}$  unless otherwise noted.

Symbol	Parameter	Value	Unit
$V_{CBO}$	Collector-Base Voltage	BC846	80
		BC847 / BC850	50
		BC848	30
$V_{CEO}$	Collector-Emitter Voltage	BC846	65
		BC847 / BC850	45
		BC848	30
$V_{EBO}$	Emitter-Base Voltage	BC846 / BC847	6
		BC848 / BC850	5
$I_C$	Collector Current (DC)	100	mA
$T_J$	Junction Temperature	150	$^\circ\text{C}$
$T_{STG}$	Storage Temperature Range	-65 to +150	$^\circ\text{C}$

## Thermal Characteristics<sup>(2)</sup>

Values are at  $T_A = 25^\circ\text{C}$  unless otherwise noted.

Symbol	Parameter	Value	Unit
$P_D$	Power Dissipation	310	mW
	Derate Above $25^\circ\text{C}$	2.48	mW/ $^\circ\text{C}$
$R_{\theta JA}$	Thermal Resistance, Junction-to-Ambient	403	$^\circ\text{C}/\text{W}$

### Note:

2. PCB size: FR-4, 76 mm x 114 mm x 1.57 mm (3.0 inch x 4.5 inch x 0.062 inch) with minimum land pattern size.

**Electrical Characteristics<sup>(3)</sup>**Values are at  $T_A = 25^\circ\text{C}$  unless otherwise noted.

Symbol	Parameter	Conditions	Min.	Typ.	Max.	Unit	
$I_{CBO}$	Collector Cut-Off Current	$V_{CB} = 30\text{ V}, I_E = 0$			15	nA	
$h_{FE}$	DC Current Gain	$V_{CE} = 5\text{ V}, I_C = 2\text{ mA}$	110		800		
$V_{CE(sat)}$	Collector-Emitter Saturation Voltage	$I_C = 10\text{ mA}, I_B = 0.5\text{ mA}$		90	250	mV	
		$I_C = 100\text{ mA}, I_B = 5\text{ mA}$		200	600		
$V_{BE(sat)}$	Collector-Base Saturation Voltage	$I_C = 10\text{ mA}, I_B = 0.5\text{ mA}$		700		mV	
		$I_C = 100\text{ mA}, I_B = 5\text{ mA}$		900			
$V_{BE(on)}$	Base-Emitter On Voltage	$V_{CE} = 5\text{ V}, I_C = 2\text{ mA}$	580	660	700	mV	
		$V_{CE} = 5\text{ V}, I_C = 10\text{ mA}$			720		
$f_T$	Current Gain Bandwidth Product	$V_{CE} = 5\text{ V}, I_C = 10\text{ mA},$ $f = 100\text{ MHz}$		300		MHz	
$C_{ob}$	Output Capacitance	$V_{CB} = 10\text{ V}, I_E = 0, f = 1\text{ MHz}$		3.5	6.0	pF	
$C_{ib}$	Input Capacitance	$V_{EB} = 0.5\text{ V}, I_C = 0, f = 1\text{ MHz}$		9		pF	
NF	Noise Figure	BC846 / BC847 / BC848	$V_{CE} = 5\text{ V}, I_C = 200\text{ }\mu\text{A},$ $R_G = 2\text{ k}\Omega, f = 1\text{ kHz}$		2.0	10.0	dB
		BC850			1.2	4.0	
		BC850		$V_{CE} = 5\text{ V}, I_C = 200\text{ }\mu\text{A},$ $R_G = 2\text{ k}\Omega, f = 30\text{ to }15000\text{ Hz}$		1.4	

**Note:**3. Pulse test: pulse width  $\leq 300\text{ }\mu\text{s}$ , duty cycle  $\leq 2\%$  **$h_{FE}$  Classification**

Classification	A	B	C
$h_{FE}$	110 ~ 220	200 ~ 450	420 ~ 800

## Typical Performance Characteristics

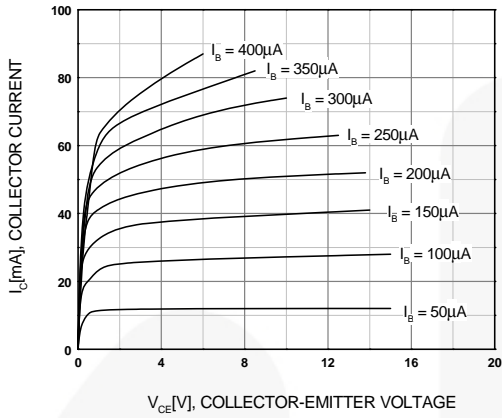

Figure 1. Static Characteristic

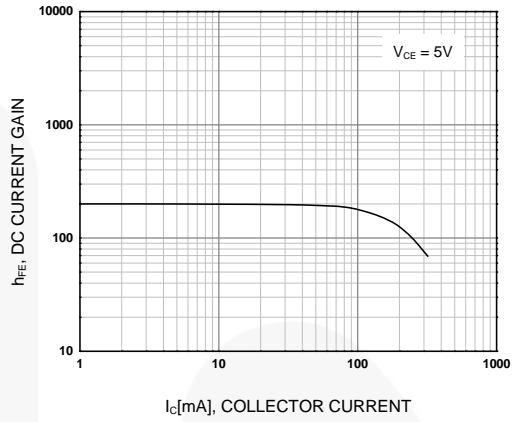

Figure 2. DC Current Gain

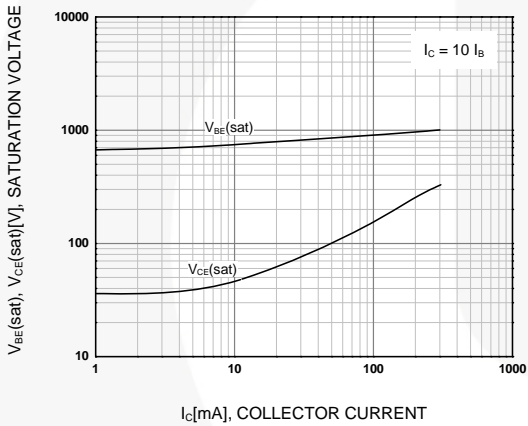

Figure 3. Base-Emitter Saturation Voltage and Collector-Emitter Saturation Voltage

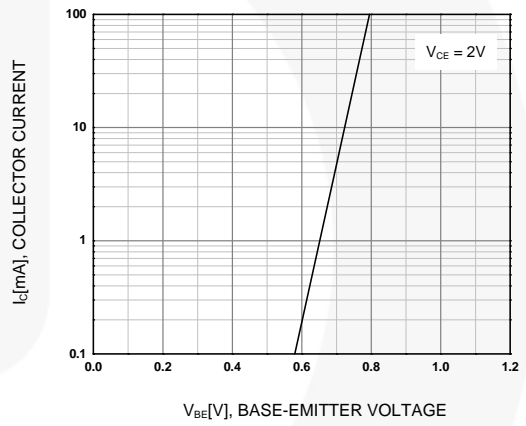

Figure 4. Base-Emitter On Voltage

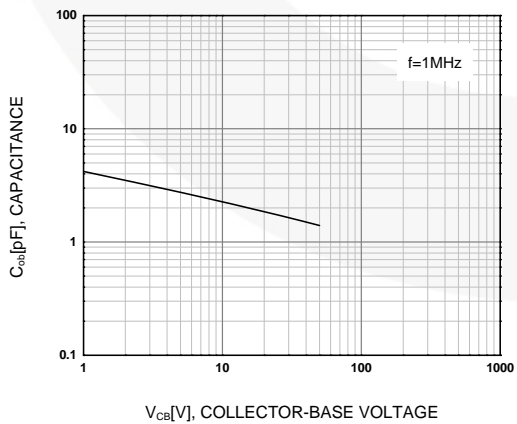

Figure 5. Collector Output Capacitance

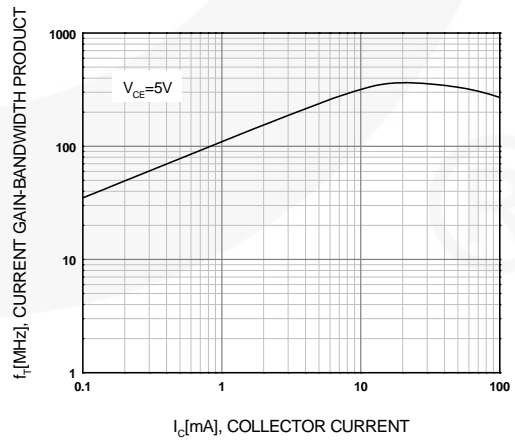
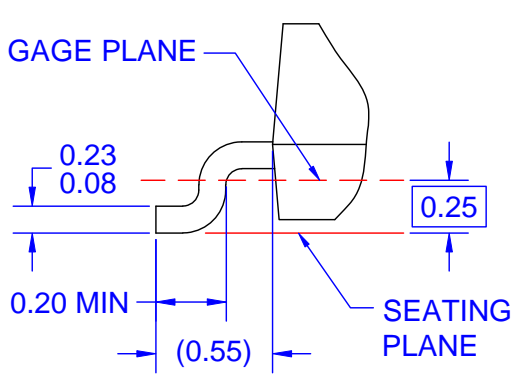
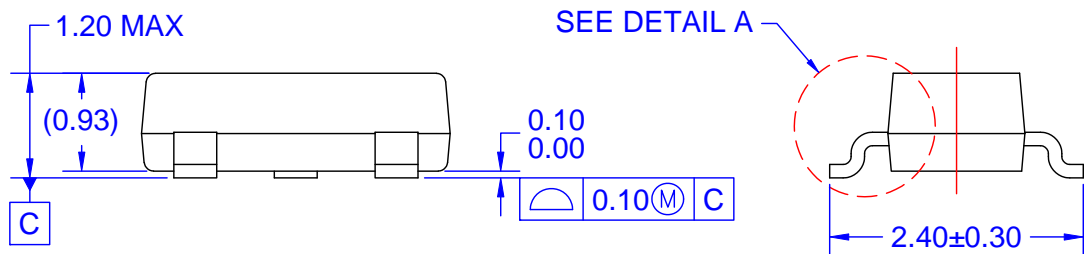

Figure 6. Current Gain Bandwidth Product



**DETAIL A**  
 SCALE: 2X





NOTES: UNLESS OTHERWISE SPECIFIED

- A) REFERENCE JEDEC REGISTRATION TO-236, VARIATION AB, ISSUE H.
- B) ALL DIMENSIONS ARE IN MILLIMETERS.
- C) DIMENSIONS ARE INCLUSIVE OF BURRS, MOLD FLASH AND TIE BAR EXTRUSIONS.
- D) DIMENSIONING AND TOLERANCING PER ASME Y14.5M - 1994.
- E) DRAWING FILE NAME: MA03DREV10



**TRADEMARKS**

The following includes registered and unregistered trademarks and service marks, owned by Fairchild Semiconductor and/or its global subsidiaries, and is not intended to be an exhaustive list of all such trademarks.

- |   |  |   |   |
|---|--|---|---|
| AccuPower™  | F-PFS™   | OPTOPLANAR®   |  |
| Awinda®   | FRFET®   |  | TinyBoost®  |
| AX-CAP®*  | Global Power Resource <sup>SM</sup>            | PowerTrench®  | TinyBuck®   |
| BitSiC™   | GreenBridge™                                   | PowerXS™  | TinyCalc™   |
| Build it Now™   | Green FPS™                                     | Programmable Active Droop™  | TinyLogic®  |
| CorePLUS™   | Green FPS™ e-Series™                           | QFET®   | TINYOPTO™   |
| CorePOWER™  | Gmax™  | QS™   | TinyPower™  |
| CROSSVOL™   | GTO™   | Quiet Series™   | TinyPWM™  |
| CTL™  | IntelliMAX™                                    | RapidConfigure™   | TinyWire™   |
| Current Transfer Logic™   | ISOPLANAR™                                     |  | TranSiC™  |
| DEUXPEED®   | Making Small Speakers Sound Louder and Better™ | Saving our world, 1mW/W/kW at a time™   | TriFault Detect™  |
| Dual Cool™  | MegaBuck™                                      | SignalWise™   | TRUECURRENT®*   |
| EcoSPARK®   | MICROCOUPLER™                                  | SmartMax™   | μSerDes™  |
| EfficientMax™   | MicroFET™                                      | SMART START™  |  |
| ESBC™   | MicroPak™                                      | Solutions for Your Success™   | UHC®  |
|  | MicroPak2™                                     | SPM®  | Ultra FRFET™  |
| Fairchild®  | MillerDrive™                                   | STEALTH™  | UniFET™   |
| Fairchild Semiconductor®  | MotionMax™                                     | SuperFET®   | VCX™  |
| FACT Quiet Series™  | MotionGrid®                                    | SuperSOT™-3   | VisualMax™  |
| FACT®   | MTi®   | SuperSOT™-6   | VoltagePlus™  |
| FAST®   | MTx®   | SuperSOT™-8   | XS™   |
| FastvCore™  | MVN®   | SupreMOS®   | Xsens™  |
| FETBench™   | mWSaver®                                       | SyncFET™  | 仙童™   |
| FPS™  | OptoHiT™                                       | Sync-Lock™  |   |
|   | OPTOLOGIC®                                     |   |   |

\* Trademarks of System General Corporation, used under license by Fairchild Semiconductor.

**DISCLAIMER**

FAIRCHILD SEMICONDUCTOR RESERVES THE RIGHT TO MAKE CHANGES WITHOUT FURTHER NOTICE TO ANY PRODUCTS HEREIN TO IMPROVE RELIABILITY, FUNCTION, OR DESIGN. TO OBTAIN THE LATEST, MOST UP-TO-DATE DATASHEET AND PRODUCT INFORMATION, VISIT OUR WEBSITE AT [HTTP://WWW.FAIRCHILDSEMI.COM](http://www.fairchildsemi.com). FAIRCHILD DOES NOT ASSUME ANY LIABILITY ARISING OUT OF THE APPLICATION OR USE OF ANY PRODUCT OR CIRCUIT DESCRIBED HEREIN; NEITHER DOES IT CONVEY ANY LICENSE UNDER ITS PATENT RIGHTS, NOR THE RIGHTS OF OTHERS. THESE SPECIFICATIONS DO NOT EXPAND THE TERMS OF FAIRCHILD'S WORLDWIDE TERMS AND CONDITIONS, SPECIFICALLY THE WARRANTY THEREIN, WHICH COVERS THESE PRODUCTS.

**LIFE SUPPORT POLICY**

FAIRCHILD'S PRODUCTS ARE NOT AUTHORIZED FOR USE AS CRITICAL COMPONENTS IN LIFE SUPPORT DEVICES OR SYSTEMS WITHOUT THE EXPRESS WRITTEN APPROVAL OF FAIRCHILD SEMICONDUCTOR CORPORATION.

As used herein:

1. Life support devices or systems are devices or systems which, (a) are intended for surgical implant into the body or (b) support or sustain life, and (c) whose failure to perform when properly used in accordance with instructions for use provided in the labeling, can be reasonably expected to result in a significant injury of the user.
2. A critical component in any component of a life support, device, or system whose failure to perform can be reasonably expected to cause the failure of the life support device or system, or to affect its safety or effectiveness.

**ANTI-COUNTERFEITING POLICY**

Fairchild Semiconductor Corporation's Anti-Counterfeiting Policy. Fairchild's Anti-Counterfeiting Policy is also stated on our external website, [www.fairchildsemi.com](http://www.fairchildsemi.com), under Sales Support.

Counterfeiting of semiconductor parts is a growing problem in the industry. All manufacturers of semiconductor products are experiencing counterfeiting of their parts. Customers who inadvertently purchase counterfeit parts experience many problems such as loss of brand reputation, substandard performance, failed applications, and increased cost of production and manufacturing delays. Fairchild is taking strong measures to protect ourselves and our customers from the proliferation of counterfeit parts. Fairchild strongly encourages customers to purchase Fairchild parts either directly from Fairchild or from Authorized Fairchild Distributors who are listed by country on our web page cited above. Products customers buy either from Fairchild directly or from Authorized Fairchild Distributors are genuine parts, have full traceability, meet Fairchild's quality standards for handling and storage and provide access to Fairchild's full range of up-to-date technical and product information. Fairchild and our Authorized Distributors will stand behind all warranties and will appropriately address any warranty issues that may arise. Fairchild will not provide any warranty coverage or other assistance for parts bought from Unauthorized Sources. Fairchild is committed to combat this global problem and encourage our customers to do their part in stopping this practice by buying direct or from authorized distributors.

**PRODUCT STATUS DEFINITIONS**

**Definition of Terms**

Datasheet Identification	Product Status	Definition
Advance Information	Formative / In Design	Datasheet contains the design specifications for product development. Specifications may change in any manner without notice.
Preliminary	First Production	Datasheet contains preliminary data; supplementary data will be published at a later date. Fairchild Semiconductor reserves the right to make changes at any time without notice to improve design.
No Identification Needed	Full Production	Datasheet contains final specifications. Fairchild Semiconductor reserves the right to make changes at any time without notice to improve the design.
Obsolete	Not In Production	Datasheet contains specifications on a product that is discontinued by Fairchild Semiconductor. The datasheet is for reference information only.

Rev. I72

# Mouser Electronics

Authorized Distributor

Click to View Pricing, Inventory, Delivery & Lifecycle Information:

[Fairchild Semiconductor:](#)

[BC849AMTF](#) [BC849CMTF](#) [BC849BMTF](#)