

High Accuracy Current and Power Monitor Evaluation Board

General Description

This document provides information on the function and use of the RTQ6053 evaluation board (EVB), as well as instructions for operating and modifying the board and circuit to meet individual requirements. Additionally, it includes details on the schematic diagram, bill of materials, and evaluation board layout.

Table of Contents

General Description	1
Performance Specification Summary	2
Power-up Procedure	2
Detailed Description of Hardware	5
Bill of Materials.....	6
Typical Applications	7
Evaluation Board Layout.....	9
Important Notice for Richtek Evaluation Board.....	10

Performance Specification Summary

Summary of the RTQ6053GQV Evaluation Board performance specification is provided in Table 1. The ambient temperature is 25°C.

Table 1. RTQ6053GQV Evaluation Board Performance Specification Summary

Specification	Test Conditions	Min	Typ	Max	Unit
Default Input Voltage	Default = 12V	0	--	36	V
Supply Voltage	Default = 3.3V	2.7	--	5.5	V
Sensing Current		--	0.5	--	A
1 LSB Step Size	Sense voltage	--	2.5	--	μV
	Bus voltage	--	1.25	--	mV
Gain Error		--	0.02	0.3	%
Offset Voltage, RTI		--	±2.5	±25	mV
Quiescent Current	T _A = 25°C	--	550	650	μA
	Shutdown mode	--	3.5	6	μA

Power-up Procedure

Suggestion Required Equipments

- RTQ6053GQV Evaluation Board
- DC Power Supply (Chroma, 62006P-100-25)
- DC Power Supply (Agilent, E3632A)
- Electronic load capable of 6A
- DC Meter
- Richtek Wrenboard

Quick Start Procedures

1. Apply $V_S = 3.3V$ input power supply ($2.7V < V_S < 5.5V$) to VS and GND terminals.
2. Apply 12V input power voltage ($0V < IN+ < 36V$) to IN+ and GND terminals.
3. The default sense resistance is 100mΩ.
4. Connect an external load to IN- and GND terminals, and keep loading current = 0.5A.
5. Measure the sense voltage (approximately 50mV) between IN+ and IN-.
6. Use RTQ6056 GUI to check practical sense voltage, bus voltage, current and power.

Graphical User Interface



Figure 1. RTQ6053 Graphical User Interface

Configuring the RTQ6056 EVB Software

Step 1. Set the shunt resistor value.

Step 2. Set Max expected current for sensing.

Step 3. Set minimum current resolution for current LSB.

Step 4. Push “Apply” bottom, the 0x05 Calibration register is written into a value for expected current LSB.

Step 5. Select single read or continued read for showing practical data.

Alert Indicator

Figure 2 shows an example for configuring the Alert Pin. The user can monitor five alert functions or conversion ready notification through the alert config drop-down menu, and the threshold can be programmed in the Alert Limit.

The five alert functions are listed below:

- Sense Voltage Over-Limit (SOL)
- Sense Voltage Under-Limit (SUL)
- Bus Voltage Over-Limit (BOL)
- Bus Voltage Under-Limit (BUL)
- Power Over-Limit (POL)

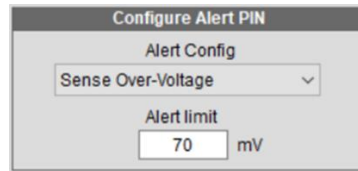
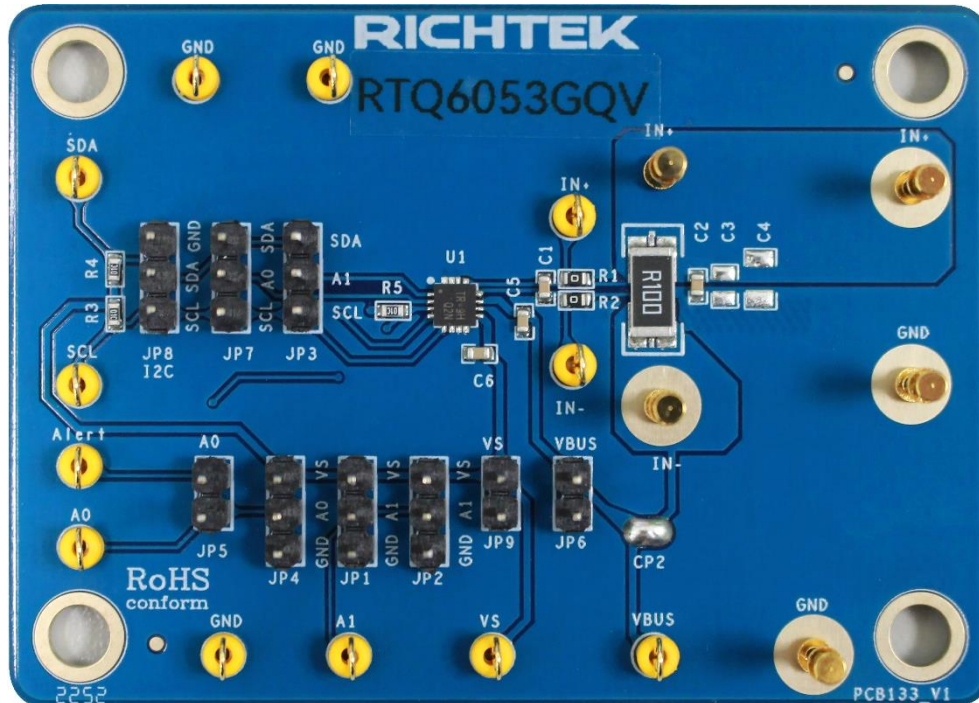

Figure 2. Configuring the Alert Pin

Detailed Description of Hardware

Headers Description and Placement



Carefully inspect all the components used in the EVB according to the following Bill of Materials table, and then make sure all the components are undamaged and correctly installed. If there is any missing or damaged component, which may occur during transportation, please contact our distributors or e-mail us at evb_service@richtek.com.

Test Points

The EVB is provided with the test points and pin names listed in the table below.

Test Point/ Pin Name	Function
A1, A0	Slave address selection.
IN+	Positive current-sensing input.
IN-	Negative current-sensing input.
VBUS	Bus voltage input.
VS	Power supply, 2.7V to 5.5V.
Alert	Multi-functional alert, open-drain output.

Bill of Materials

VIN = 12V, VS = 3.3V, IOUT = 0.5A						
Reference	Count	Part Number	Value	Description	Package	Manufacturer
U1	1	RTQ6053GQV	RTQ6053GQV	16-Bit ADC Op Amp	VQFN-16L 3x3	RICHTEK
C1, C2, C5, C6	4	0603B104K500CT	0.1μF	Capacitor, Ceramic, 50V/X7R	0603	WALSIN
C3	1	GRM21BC71E106KE11L	NC		0805	MURATA
C4	1	1206X106K500CT	NC		1206	TDK
R1, R2	2	WR06X000 PTL	0	Resistor	0603	WALSIN
R3, R4, R5	3	WR06X1002FTL	10k	Resistor	0603	WALSIN
RSEN1	1	RTT25R100FTE	0.1	Resistor	2512	RALEC

Typical Applications

EVB Schematic Diagram

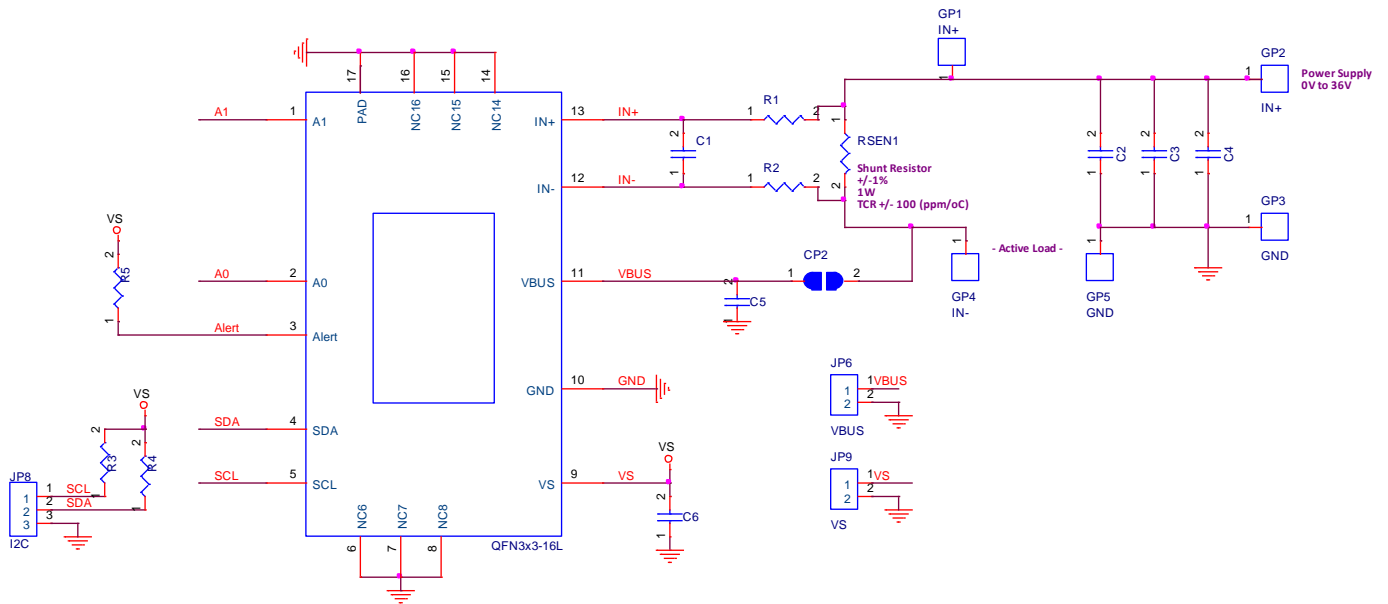

1. The capacitance values of the input and output capacitors will influence the input and output voltage ripple.
2. MLCC capacitors have degrading capacitance at DC bias voltage, and especially smaller size MLCC capacitors will have much lower capacitance.

Measurement Results

Sense Gain Error with Power Supply Measurement

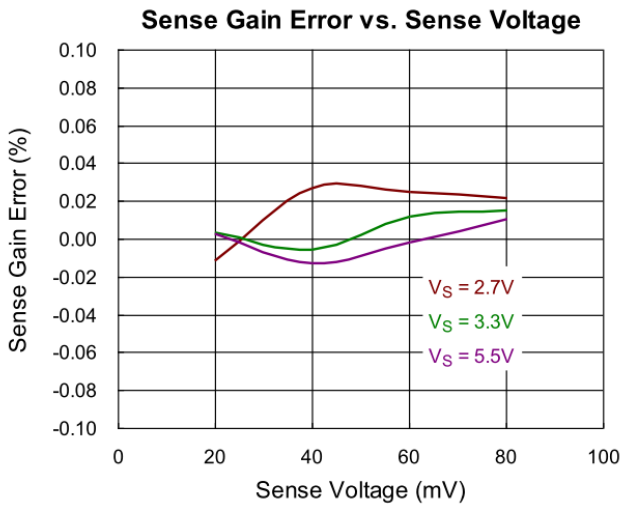

Sense Gain Error with Temperature Measurement

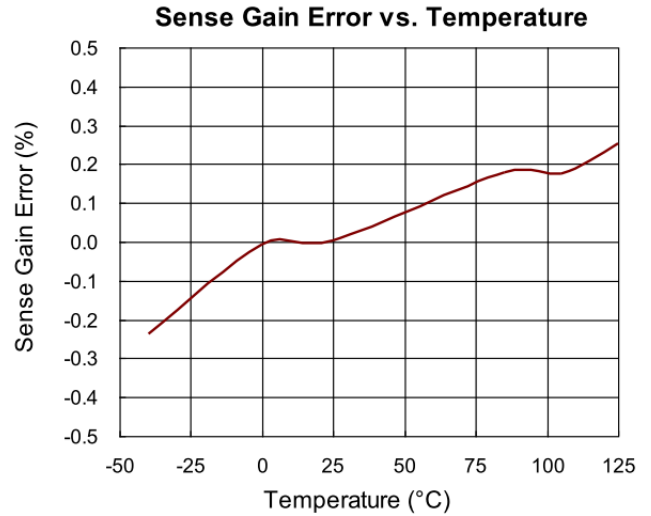

Bus Gain Error with Power Supply Measurement

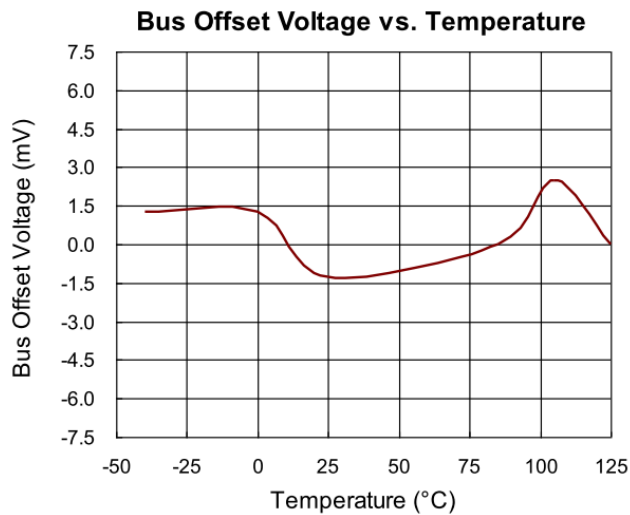

Bus Gain Error with Temperature Measurement

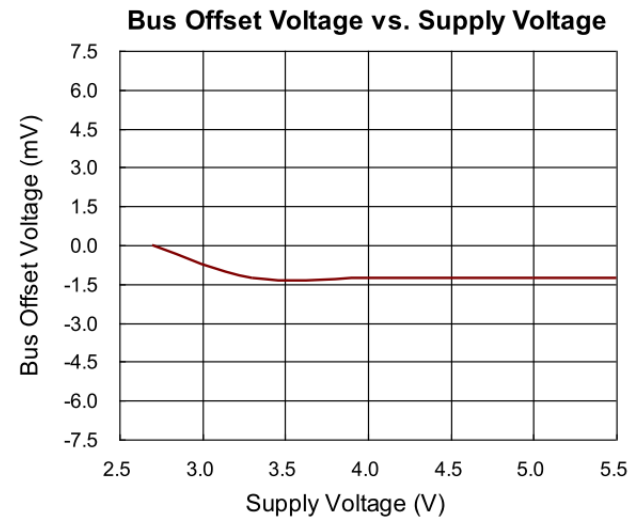

Evaluation Board Layout

Figure 3 and Figure 4 are RTQ6053GQV Evaluation Board layout. This board size is 70mm x 50mm and is constructed on two-layer PCB, outer layers with 2 oz. Cu and inner layers with 1 oz. Cu.

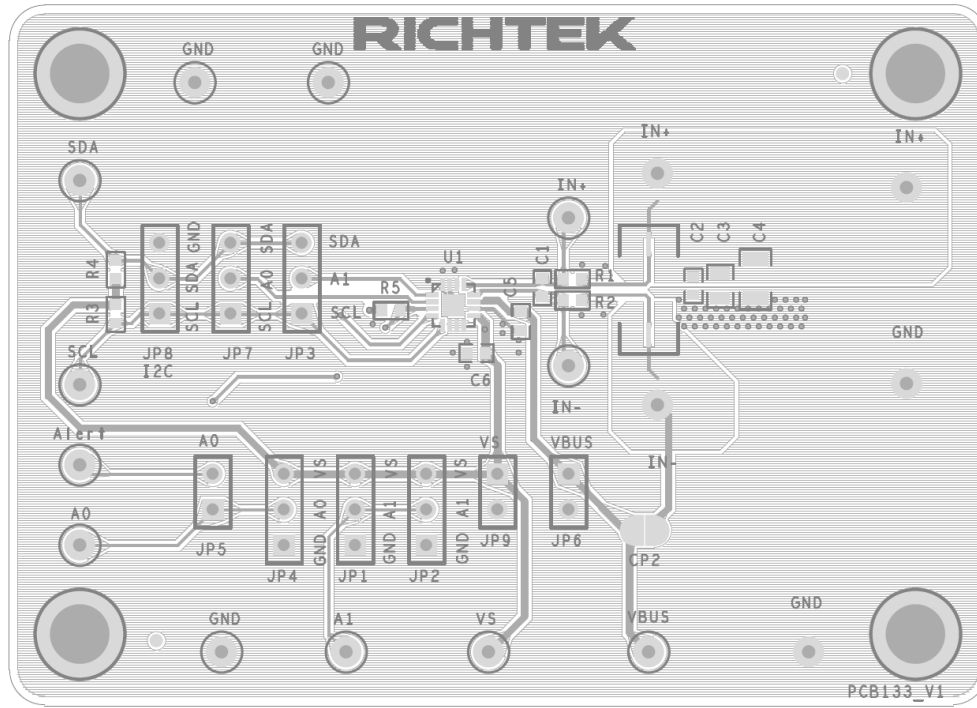

Figure 3. Top View

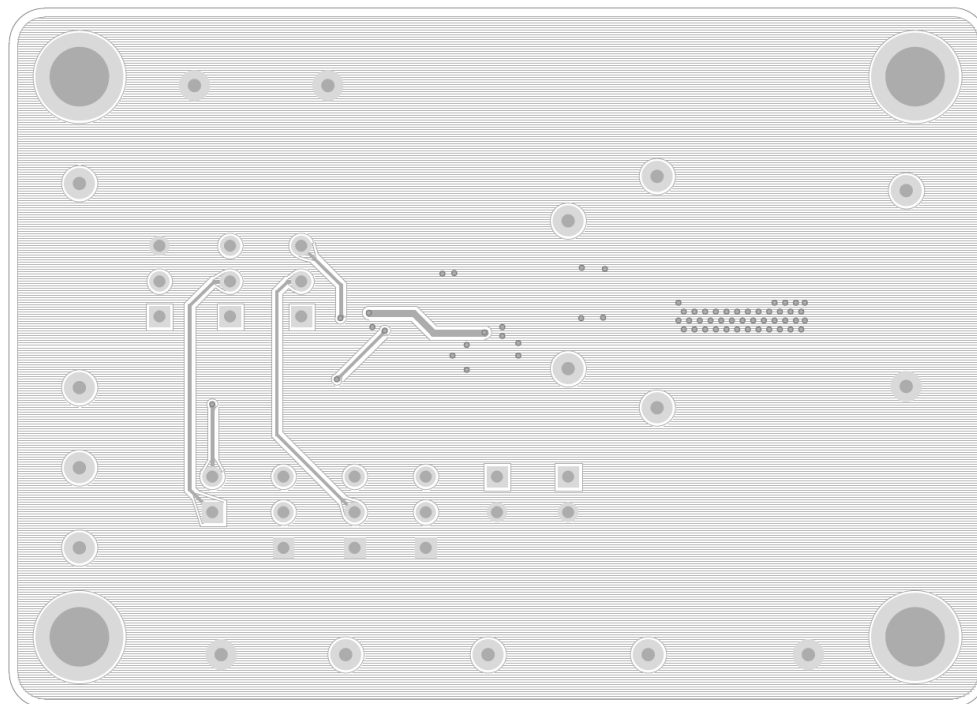

Figure 4. Bottom View

More Information

For more information, please find the related datasheet or application notes from Richtek website

<http://www.richtek.com>.

Important Notice for Richtek Evaluation Board

THIS DOCUMENT IS FOR REFERENCE ONLY, NOTHING CONTAINED IN THIS DOCUMENT SHALL BE CONSTRUED AS RICHTEK'S WARRANTY, EXPRESS OR IMPLIED, UNDER CONTRACT, TORT OR STATUTORY, WITH RESPECT TO THE PRESENTATION HEREIN. IN NO EVENT SHALL RICHTEK BE LIABLE TO BUYER OR USER FOR ANY AND ALL DAMAGES INCLUDING WITHOUT LIMITATION TO DIRECT, INDIRECT, SPECIAL, PUNITIVE OR CONSEQUENTIAL DAMAGES.

Mouser Electronics

Authorized Distributor

Click to View Pricing, Inventory, Delivery & Lifecycle Information:

[Richtek:](#)

[EVB_RTQ6053GQV](#)