

2A, 6V, Low I_Q ACOT[®] Synchronous Step-Down Converter

General Description

The RTQ2103A is a full featured 6V, 2A, Advanced Constant-On-Time (ACOT[®]) synchronous step-down converter with two integrated MOSFETs. The advanced COT operation allows transient responses to be optimized over a wide range of loads, and output capacitors to efficiently reduce external component count. This document explains the function and use of the RTQ2103A evaluation board (EVB) and provides information for the evaluation board layout, schematic, bill of materials (BOM) and measurement results to suit individual requirements.

Table of Contents

General Description	1
Performance Specification Summary	2
Power-up & Measurement Procedure	2
Detailed Description of Hardware	3
Bill of Materials.....	4
Typical Applications	5
Evaluation Board Layout.....	10
More Information.....	11
Important Notice for Richtek Evaluation Board.....	11

Performance Specification Summary

Summary of the RTQ2103AGSP-QA Evaluation Board performance specification is provided in Table 1. The ambient temperature is 25°C.

Table 1. RTQ2103AGSP-QA Evaluation Board Performance Specification Summary

Specification	Test Conditions	Min	Typ	Max	Unit
Input Voltage Range		3	--	6	V
Output Current		0	--	2	A
Default Output Voltage		0.45	--	3.3	V
Operation Frequency		2200	2700	3000	kHz
Output Ripple Voltage	$V_{IN} = 3.3V, V_{OUT} = 1.2V, I_{OUT} = 2A$	--	10	--	mVp-p
Line Regulation	$I_{OUT} = 0A, V_{IN} = 3V \text{ to } 6V$	--	± 1	--	%
Load Regulation	$V_{IN} = 3.3V, V_{OUT} = 1.2V, I_{OUT} = 1mA \text{ to } 2A$	--	± 1	--	%
Load Transient Response	$I_{OUT} = 650mA \text{ to } 1.37A$	--	± 5	--	%
Maximum Efficiency	$V_{IN} = 5V, V_{OUT} = 3.3V, I_{OUT} = 0.5A$	--	93.2	--	%

Power-up & Measurement Procedure

1. Apply a 5V nominal input power supply ($3V < V_{IN} < 6V$) to the VIN and GND terminals.
2. Set the jumper at JP1 to connect terminals 1 and 2, connecting EN to enable operation.
3. Verify the output voltage (approximately 3.3V) between VOUT and GND.
4. Connect an external load up to 2A to the VOUT and GND terminals and verify the output voltage and current.

Output Voltage Setting

Set the output voltage with the resistive divider (R24, R29) between VOUT and GND with the midpoint connected to FB. The output is set by the following formula:

$$V_{OUT} = V_{FB} \times \left(1 + \frac{R24}{R29}\right)$$

The placement of the resistive divider should be within 5mm of the FB pin. The resistance of R29 is suggested between 10kΩ and 150kΩ to minimize power consumption, and noise pick-up at the FB pin. The resistance of R24 can then be obtained as below:

$$R24 = \frac{R29 \times (V_{OUT} - V_{FB})}{V_{FB}}$$

For better output voltage accuracy, divider resistors (R24 and R29) should have tolerance of $\pm 1\%$ tolerance or better.

Detailed Description of Hardware

Headers Description and Placement

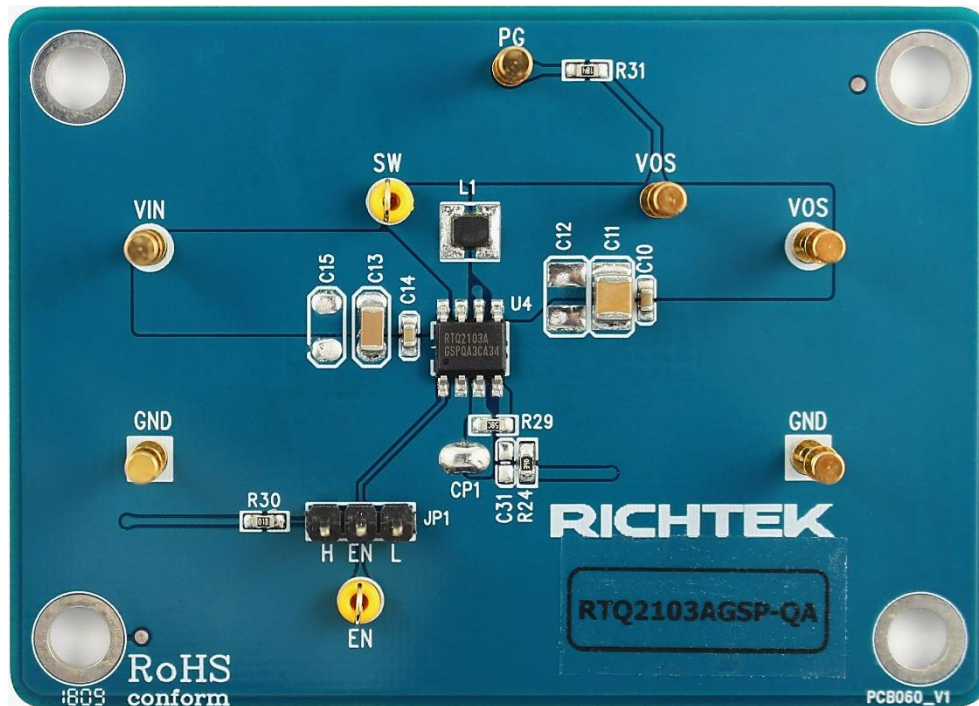

Carefully inspect all the components used in the EVB according to the following Bill of Materials table, and then make sure all the components are undamaged and correctly installed. If there is any missing or damaged component, which may occur during transportation, please contact our distributors or e-mail us at evb_service@richtek.com.

Test Points

The EVB is provided with the test points and pin names listed in the table below.

Test point/ Pin name	Signal	Comment (expected waveforms or voltage levels on test points)
EN	Enable Test Point	Chip enable. Externally pulled high to enable and pulled low to disable this chip.
PGND, GND	Power Ground	The exposed pad must be soldered to a large PCB and connected to PGND for maximum power dissipation.
AGND	Analog Ground	Should be electrically connected to GND close to the device.
FB	Feedback	Feedback voltage input.
VOS	Output Voltage Sense	Output voltage sense pin for the internal control loop. Must be connected to output.
PG	Power Good Test Point	Output of power good indicator.
SW	Switch Node Test Point	Switch node.
VIN	Input Voltage	Power input.

Bill of Materials

Reference	Qty	Part Number	Description	Package	Manufacturer
U4	1	RTQ2103AGSP-QA	DC-DC Converter	PSOP-8	RICHTEK
C10, C14	2	GRM188R71H104KA93D	0.1 μ F/50V/X7R	0603	MURATA
C11	1	GRM32E61E226KE15L	22 μ F/25V/X5R	1210	MURATA
C12	1		NC	1206	
C13	1	C3216X5R1H106KT000N	10 μ F/50V/X5R	1206	TDK
C15	1		NC	1206	
C31	1		NC	0603	
L1	1	PST25201B-1R0MS	1 μ H	2x2.5x1.2mm	CYNTEC
R24	1	WR06X6532FTL	249k	0603	WALSIN
R29	1	WR06X3922FTL	39.2k	0603	WALSIN
R30	1	WR06X1003FTL	100k	0603	WALSIN
R31	1	WR06X1803FTL	180k	0603	WALSIN
CP1	1		Short		

Typical Applications

EVB Schematic Diagram

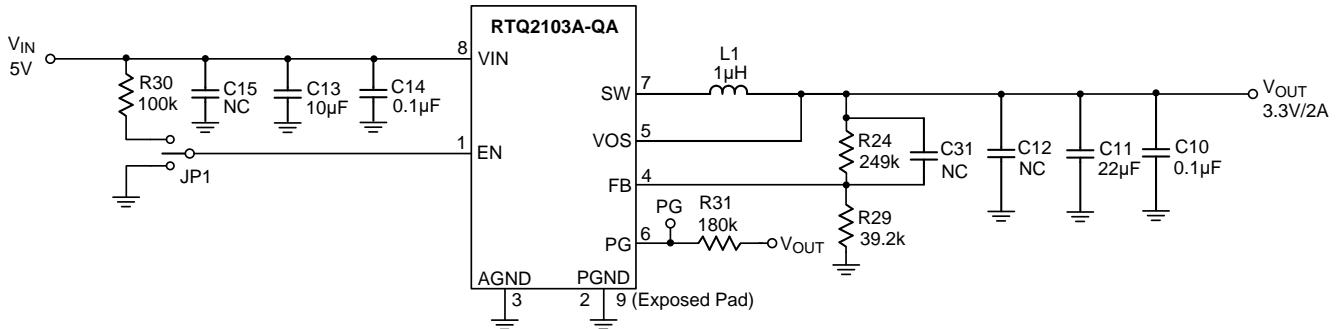

C13 : 10µF/50V/1206 TDK C3216X5R1H106KT000N
 C11 : 22µF/25V/1210 Murata GRM32E61E226KE15L
 L1 : 1µH PST25201B-1R0MS / CYNTEC / $I_{SAT} = 2.7A / 37m\Omega$

Note :

1. Do not hot-plug a live 5V supply to the board; if hot-plugging is required, add ~100µF electrolytic capacitor at the input.

A small feedforward capacitor (C31) can be introduced into the feedback network to speed up the transient response of high output voltage circuits. Adding C31 can also improve the light load PSM switching behavior. The feedforward capacitor is added across the upper FB divider.

To optimize transient response, C31 value is chosen so that the gain and phase boost of the feedback network increases the bandwidth of the converter, while still maintaining an acceptable phase margin. Generally, larger C31 values provide higher bandwidth, but may result in an unacceptable phase margin or instability.

Measurement Results

Output ripple measurement, 10mA load

Cyan: V-SW; Blue: VOUT

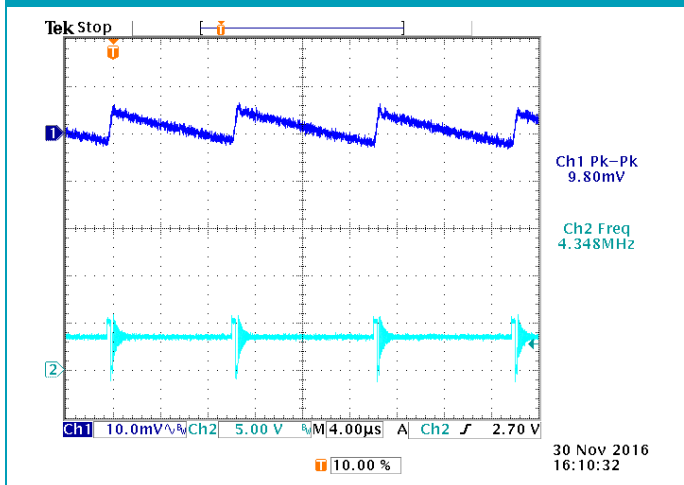

Output ripple: 9.8mVpp (PSM mode)

Output ripple measurement, 2A load

Cyan: V-SW; Blue: VOUT

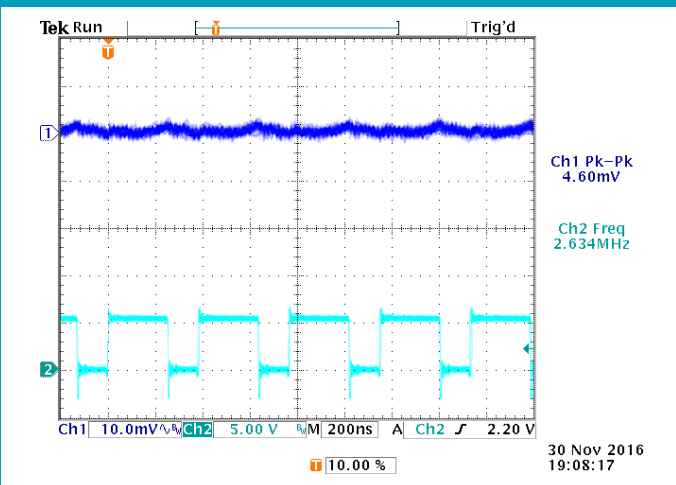

Output ripple: 4.6mVpp, Frequency: 2.634MHz

Dynamic load 650mA to 1.37A (PWM)

Blue: VOUT; Green: Load current step

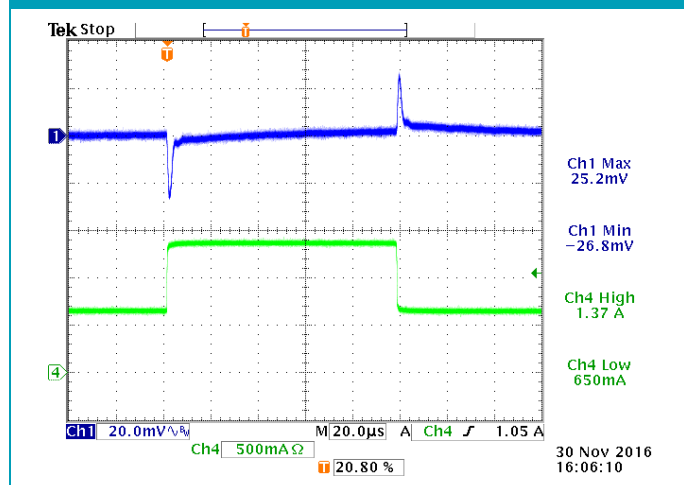

Overshoot: 25.2mV, undershoot: 26.8mV

Fast dynamic load 90mA to 810mA

(PSM – PWM transition)

Blue: VOUT; Green: Load current step

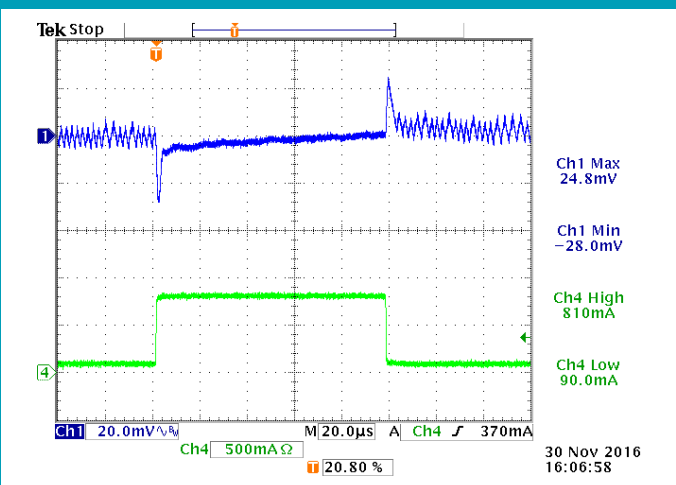

Overshoot: 24.8mV, undershoot: 28mV

OCP measurement: Dynamic load close to OCP
 Blue: VOUT; Purple: PGOOD; Green: IOUT

OCP measurement:
 Increase load current to reach OC limit
 Blue: VOUT; Purple: PGOOD; Green: IOUT

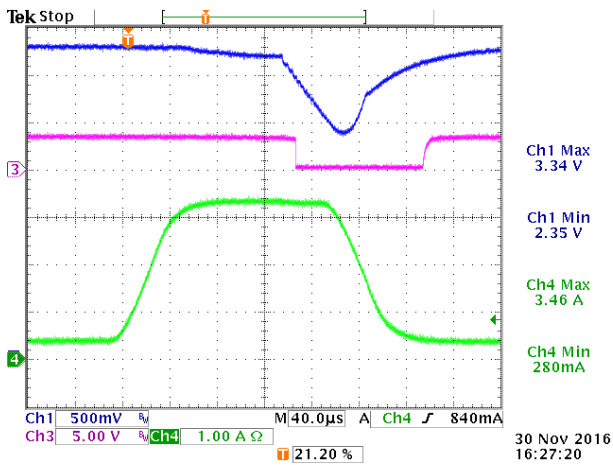

V-out starts to drop at 3.46A load current

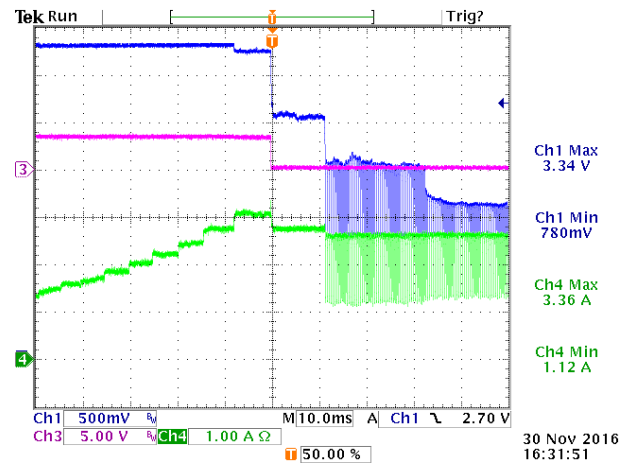

Auto-recovery hiccup mode when OC limit is exceeded

Start-up measurement from Enable: EN pin low – high
 Cyan: V-Enable; Blue: VOUT; Purple: PGOOD; Green: IOUT

Start-up measurement from VIN
 Cyan: VIN; Blue: VOUT; Purple: PGOOD; Green: IOUT

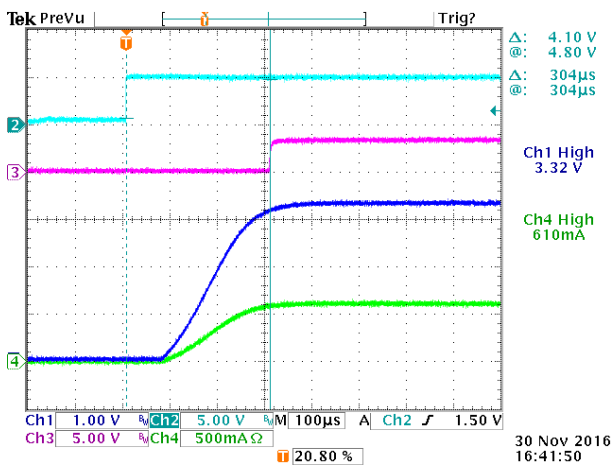

Start-up time 304µsec. Soft-start 224µsec

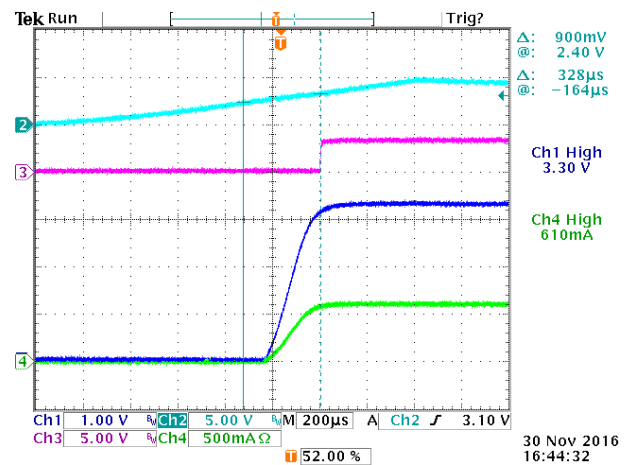

VIN > 2.4V initiates start-up

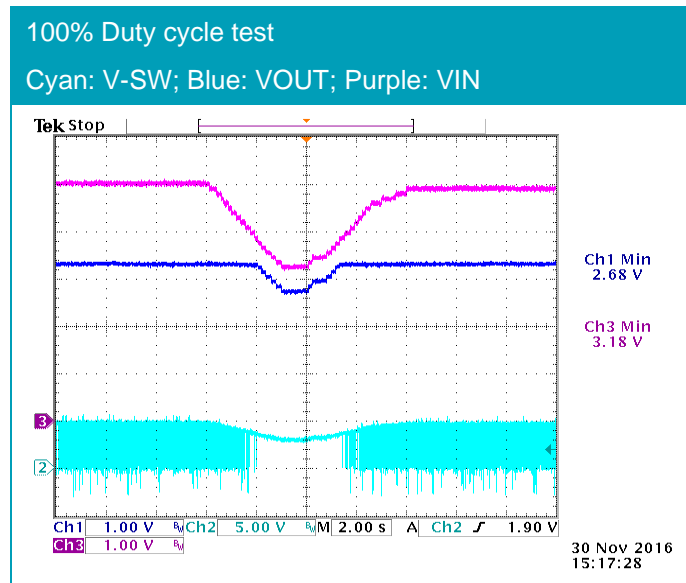

Efficiency Measurements

5V to 3.3V

V _{IN} (V)	V _{OUT} (V)	I _{IN} (A)	I _{OUT} (A)	Efficiency (%)
4.99896	3.30416	0.00084	0.00101	79.4
4.99982	3.30873	0.00376	0.00498	87.7
4.99951	3.31045	0.00738	0.00997	89.4
4.99876	3.32859	0.03655	0.05001	91.1
4.99914	3.31526	0.07247	0.10001	91.5
5.00026	3.30779	0.21491	0.30016	92.4
4.99888	3.31052	0.35531	0.50022	93.2
4.99927	3.31346	0.49902	0.70030	93
4.99959	3.31701	0.72110	1.00040	92
5.00025	3.32051	1.10942	1.50068	89.8
5.00018	3.32091	1.52368	2.00095	87.2

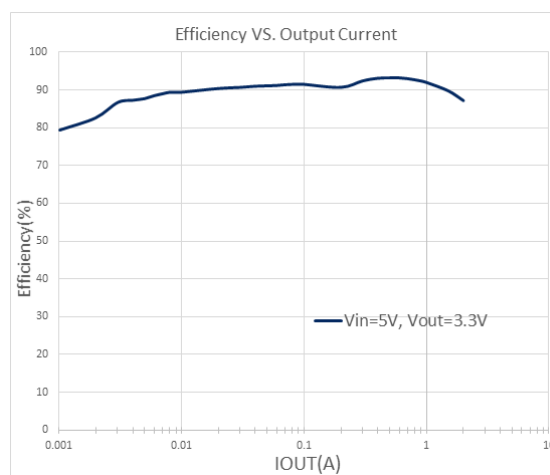

Evaluation Board Layout

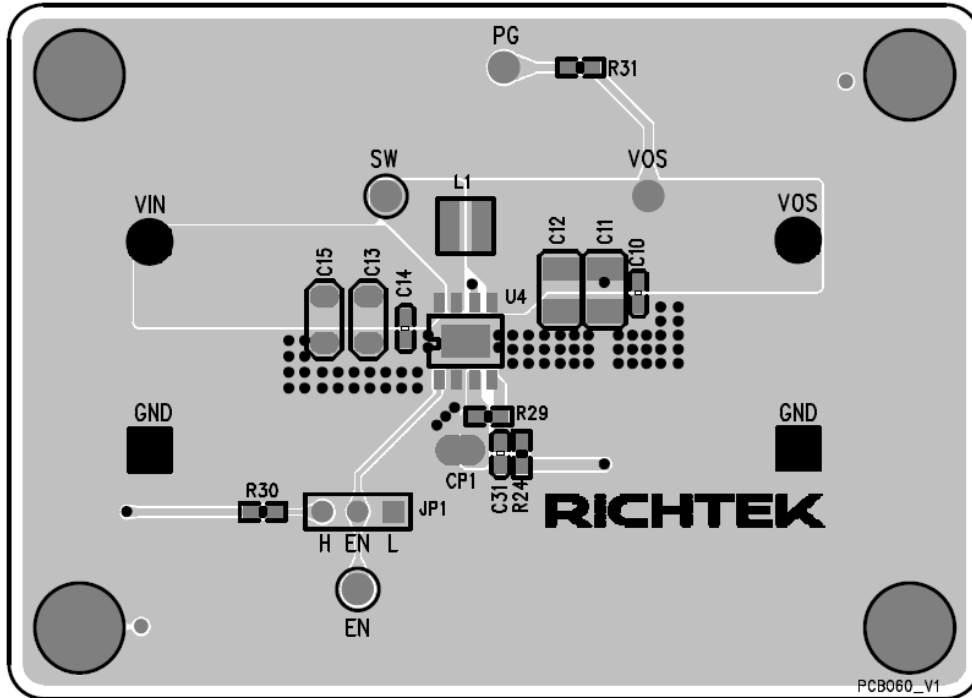

Figure 1. Top View

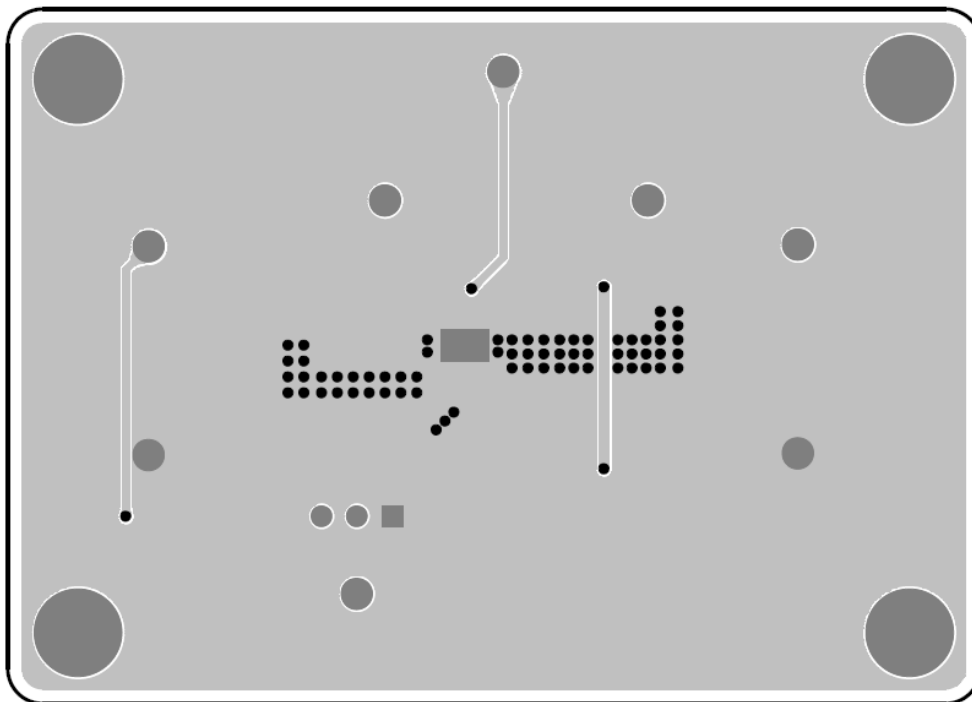

Figure 2. Bottom View

More Information

For more information, please find the related datasheet or application notes from Richtek website <http://www.richtek.com>.

Important Notice for Richtek Evaluation Board

THIS DOCUMENT IS FOR REFERENCE ONLY, NOTHING CONTAINED IN THIS DOCUMENT SHALL BE CONSTRUED AS RICHTEK'S WARRANTY, EXPRESS OR IMPLIED, UNDER CONTRACT, TORT OR STATUTORY, WITH RESPECT TO THE PRESENTATION HEREIN. IN NO EVENT SHALL RICHTEK BE LIABLE TO BUYER OR USER FOR ANY AND ALL DAMAGES INCLUDING WITHOUT LIMITATION TO DIRECT, INDIRECT, SPECIAL, PUNITIVE OR CONSEQUENTIAL DAMAGES.

Mouser Electronics

Authorized Distributor

Click to View Pricing, Inventory, Delivery & Lifecycle Information:

[Richtek:](#)

[EVB_RTQ2103AGSP-QA](#)